



3 1761 06706599 5

THE HALF TONE PROCESS

JULIUS VERFASSER



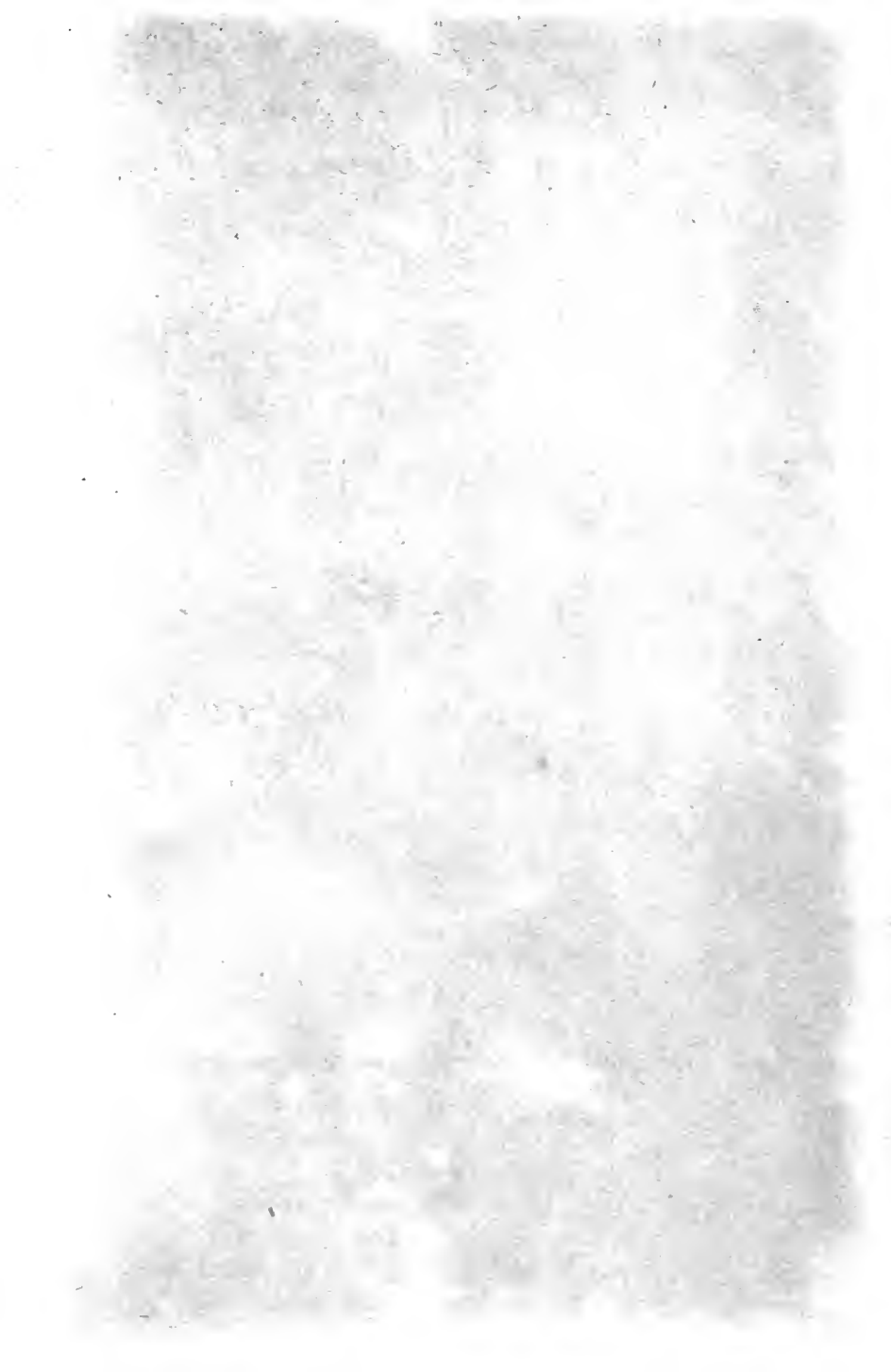

Digitized by the Internet Archive
in 2007 with funding from
Microsoft Corporation

THE
HALF-TONE PROCESS.



Three Colour Blocks
by
John Swain & Son, Ltd.,
89-90 Shoe Lane, E.C.

THE ORANGE GIRL.

Ver

THE HALF-TONE PROCESS.

A PRACTICAL MANUAL OF PHOTO-ENGRAVING
IN HALF-TONE ON ZINC, COPPER, AND BRASS.
WITH CHAPTERS ON THREE-COLOUR WORK AND
PHOTO-LITHOGRAPHY FOR OFFSET PRINTING.

BY
JULIUS VERFASSER.

FIFTH EDITION.

FULLY REVISED.

[ALL RIGHTS RESERVED.]

LONDON:
ILIFFE & SONS LIMITED.

148415
14/2/19

ILIFFE & SONS LIMITED, LONDON AND COVENTRY.

CONTENTS.

PART I.—THE STUDIO, FITTINGS, TOOLS AND APPLIANCES.

CHAPTER I.		PAGE
WHAT IS HALF-TONE ?	13
CHAPTER II.		
THE SCREEN	28
CHAPTER III.		
THE STUDIO : ITS CONSTRUCTION AND EQUIPMENT		42
CHAPTER IV.		
THE DARK ROOM	84
CHAPTER V.		
THE METAL PRINTING ROOM	113
CHAPTER VI.		
THE ELECTRIC LIGHT INSTALLATION	137
CHAPTER VII.		
THE ETCHING ROOM	158
CHAPTER VIII.		
THE MOUNTING	186
CHAPTER IX.		
PROOFING	209
CHAPTER X.		
THE MATERIALS USED	215

PART II.—THE OPERATIONS.

	PAGE
CHAPTER XI.	
THE PHOTOGRAPHIC OPERATIONS	232
CHAPTER XII.	
MAKING THE NEGATIVE	254
CHAPTER XIII.	
PRINTING FROM THE NEGATIVE	274
CHAPTER XIV.	
ETCHING THE PLATE	299
CHAPTER XV.	
MACHINE ETCHING	318
CHAPTER XVI.	
FINISHING AND MOUNTING	330
CHAPTER XVII.	
PROOFING THE PLATES	342
CHAPTER XVIII.	
THE THREE-COLOUR HALF-TONE PROCESS ..	348
CHAPTER XIX.	
DUOTYPES OR TWO-COLOUR HALF-TONES ..	362
CHAPTER XX.	
PHOTO-LITHOGRAPHY IN HALF-TONE	365
CHAPTER XXI.	
PREPARATION OF ORIGINALS	372

PREFACE TO FIFTH EDITION.

IN preparing this new edition for the press the author has again made a thorough revision, and has added all matter that seemed necessary to bring it up to date.

It hardly seems possible to add anything to make the book more complete as a practical work. The reader is assumed to have already a knowledge of elementary photographic processes, and the author has not attempted to deal with the historical or theoretical features of the half-tone process.

The book aims at being a guide to the current practice of working the half-tone process, and obsolete or little-used processes have been ignored, except in so far as it might be necessary to refer to them as explanatory of the advantages of the newer methods.

The chapter on three-colour half-tone has been brought up to date with substantial additions, as demanded by the considerable progress which has been made in this department since the issue of the last volume. It must be remembered, however, that to treat this subject properly would fill a volume in itself, and the author has therefore been unable to do more than indicate how black and white half-tone merges into three-colour work.

A new chapter has been added dealing with duotypes and two-colour half-tones.

The great importance of half-tone photo-lithography for offset printing has rendered the addition of a special new chapter necessary for treating this subject.

Important developments have been made in machine etching, which was only briefly mentioned in the last edition as a possibility of the future. It is therefore requisite to devote a special chapter to this subject.

The author has endeavoured throughout to indicate the differences between English, Continental, and American practice.

That there may be some omissions and shortcomings in the book the author admits is quite possible, though every endeavour has been made to avoid them. Different workers may have different ways of working, and may look at the matter from a different point of view from that of the author, but he can honestly assert that he has endeavoured to deal with the subject thoroughly and in such a way as to make it useful to the greatest number of readers.

As before, the author seeks no credit personally for the work, and subscribes himself again with the *nom de plume*,

JULIUS VERFASSER.

NOTE.

The proportions of the English and metrical quantities in this book may not be quite exact, but will be found near enough for all practical purposes, and small fractions have thus been avoided.

PART I.
THE STUDIO, FITTINGS, TOOLS,
AND APPLIANCES.

CHAPTER I.

WHAT IS HALF-TONE ?

IT is desirable that the reader of this book, who, it may be assumed, is entering upon the practice of this process without previous knowledge, should have a clear conception of what is meant by the term "half-tone" in its application to the making of blocks by photographic processes.

Now, in a photograph, or in a black and white drawing, the shades of colour between light and shadow are termed "half-tones," and it is only possible to reproduce these half-tones in relief blocks for letterpress printing by means of a graduated grain, or by fine lines, or by tiny dots of varying size.

The "half-tone process," as commonly understood, is a method by which half-tones of photographs or drawings are reproduced in fine dots of varying size, formed by means of a network of lines ruled on glass and placed in front of the sensitive plate when taking the photographic negative which is employed for making the printing block.

It would, on first consideration, seem probable that the effect of placing the network of lines in front of the plate would be to cut up the image into tiny squares, which would be all of the same size, only varying in density according to whether the square happened to be in a light or a shadow, so that when

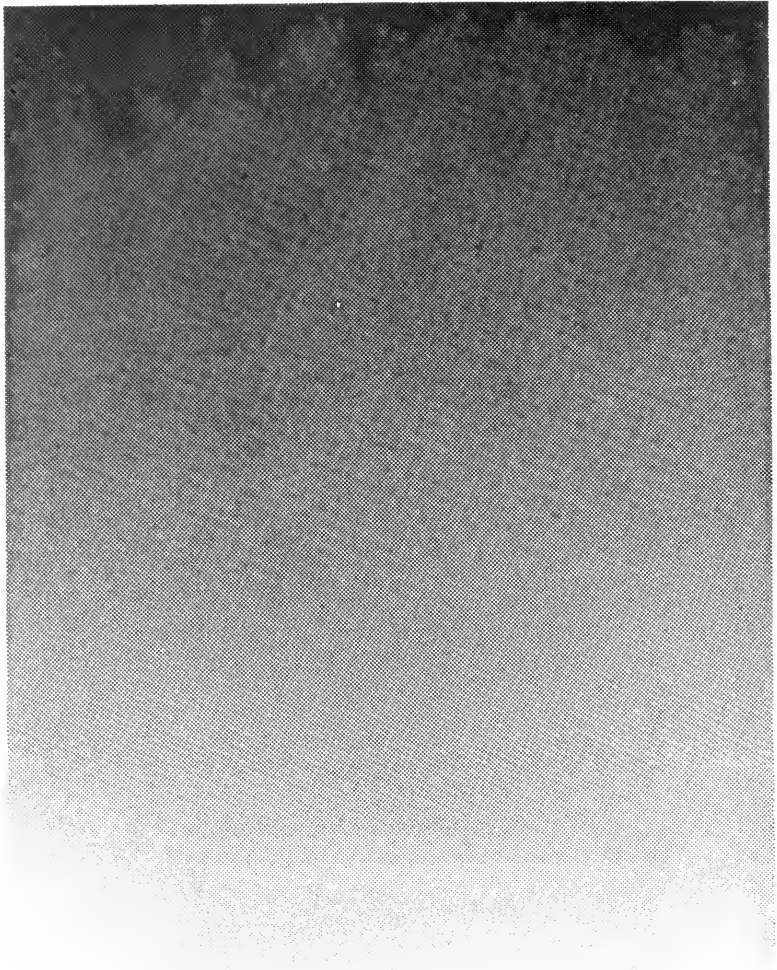

PHOTOGRAPHED FROM A GRADUATED TINT.

FIG. 1.—Shadow to High Lights.

the negative was printed the print would be simply covered with black lines, and the picture only imperfectly seen between them.

As a matter of fact, however, by suitable manipulation, which it is the object of this book to describe, the image is broken up into dots which are of varying size but of equal density—just the opposite to what we have been led to expect, but an effect which exactly suits our purpose.

Let us stop to consider for a moment what we require in a relief block for letterpress printing. It must present a level surface to the inking rollers and the impression cylinder. We cannot roll more ink on the darker shades of the engraving, and less ink on the lighter parts; the ink rollers deposit an even film of ink on the

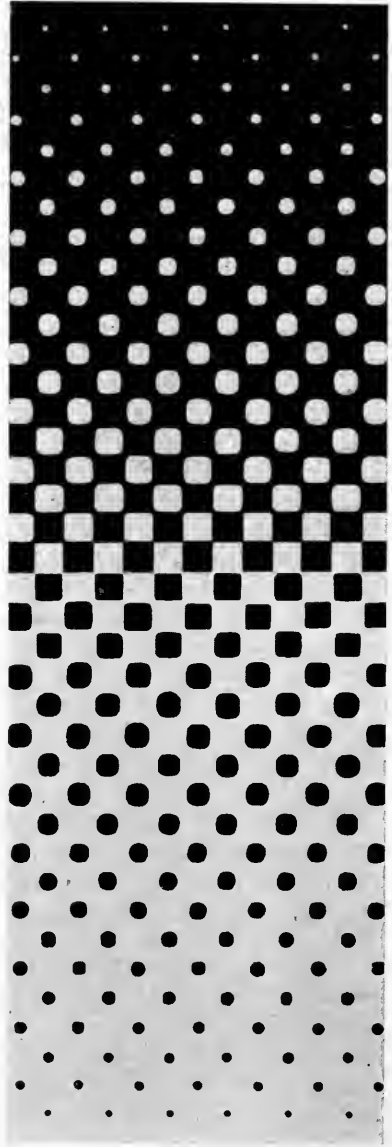

FIG. 2.—The ideal scale of gradation from Shadows to High Lights in a Negative.

block. But if the lights of the picture are hollow spaces and the shadows are solid parts, level with the surface, whilst the half-tones are formed of dots of varying degrees of fineness, we shall surely get an equivalent for our inability to deposit more or less ink on the various parts of the block. These little dots will present different areas of surface to the rollers, and will, consequently, graduate the tones of the picture from the solid black of the shadows until they melt away into extremely fine points, which, to the naked eye, are hardly distinguishable from the white ground of the paper.



FIG. 3.

To make the matter clear we give on page 14 a piece of a rather coarse screen half-tone block showing the varying degrees of dots from shadows to high lights (fig. 1). If this page is placed at such a distance from the eye that the dots are no longer visible, the effect will be simply that of a tint graduated from black to white. Fig. 2 shows the ideal scale of gradation from shadows to high lights which should be obtained in a half-tone reproduction of a graduated tint, but in practice it is not found possible to obtain in the negative this smooth transition from one tone to another. By using a sufficiently fine network to

produce the dot effect, we render the dots practically invisible to the naked eye when the page on which they are printed is held at the usual distance from the eye when reading. This will be judged by viewing the next example (fig. 3), which is produced with a network of 150 lines to the inch.

An examination of figs. 3a and 3b, which are negative and positive enlargements of the same subject (the small portrait fig. 3c), will enable the reader to understand fully that the picture is built up purely of a structure of dots of varying size. The negative result illustrates how the dots are really a little smaller in the shadows and become widened in etching the print, and the points in the high lights are a little larger and etch away somewhat.

It is most important that the structure of the half-tone print should be thoroughly grasped, as well as the fact that the negative is nothing more than the reverse of this, consisting of a black ground with transparent spaces—a kind of stencil plate—the holes corresponding to the dots to be printed in ink on the paper.

Thus, it can be readily seen that if we coat a piece of polished metal, such as copper or zinc, with a substance which is sensitive to light, and which, on account of that property, becomes so hardened that the portions acted on by light cannot be washed off the plate by bathing it in water, we can lay the negative on such a plate and expect to get a picture on the metal surface in insoluble dots, the unaffected chemical substance between the dots being washed away.



BLOCK BY THE L.C.C. SCHOOL OF PHOTO-ENGRAVING.

FIG. 3a.—Negative of the Print on opposite page.



BLOCK BY THE L.C.C. SCHOOL OF PHOTO-ENGRAVING.

FIG. 3b.—Positive Print from the Negative fig. 3c.

If, further, we can harden these dots to such an extent that they resist acids or some chemical solution which attacks and eats away the metal, we have got all the elements required for producing a block in relief. The space surrounding the dots is etched away, leaving the dots standing up as little pyramids with a flat top, which is larger or smaller according to the size of the section of the pyramid. All the tops have, of course, the same level, and stand practically the same height from the base line, but they have different areas. This will be best understood by an inspection of fig. 4.



FIG. 3c.

Suppose we start with a plate which is presumed to consist of a series of pyramids, and the action of the light is equivalent to shaving off the tops of the pyramids. Then such action in the negative would

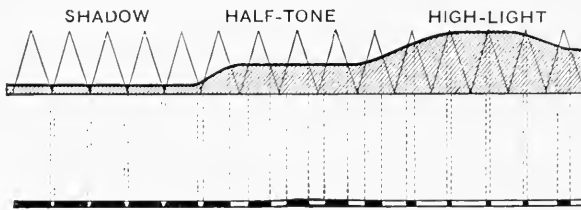

FIG. 4.

be represented by the curved line, and the point where this line cuts through the pyramids will determine the area of the chopped-off pyramid which is to form the printing surface. We have next to imagine that these areas are transferred to a common level, as

shown by bringing them down with dotted lines on the diagram, so that the lower part may be looked upon as an enlarged section of the printing surface of the plate.

The early experimenters in half-tone actually carried out this principle mechanically in various ways. For instance, a gelatine relief was obtained from the photograph, this relief having an undulating surface corresponding to the curved line in fig. 4. A mould or cast was taken from this in a white substance, and after the surface had been blackened it was cut through in lines with a V-shaped tool on a planing machine. Naturally, as the tool ploughed through the highest parts of the relief the deepest cut was made, and the pyramid was left with the smallest black cap or point. In the lowest parts of the relief the tool only skimmed over the surface, so that a large patch of black was left. As the lines made by the first cutting of the V tool were crossed, the final result was a surface consisting of a series of small black squares of varying size. On this plate or cast being photographed in a reduced size, so that the dots were fined down, the result was a very fair imitation of the tones of the picture. This process was equivalent to bringing the tops of the pyramids down to a common level, as shown in fig. 4.

It was not until it was discovered that this mechanical V principle could be converted into an optical V principle by means of a ruled screen in the camera that the half-tone process emerged from its experimental stages. The cross-lined screen may be said to

create a series of pyramids of light, which flatten themselves out more or less on the sensitive plate, and thus produce larger or smaller dots of blackened silver on the developed negative.

What actually happens is that the pyramids of light, according to their intensity, affect a larger or smaller area of the sensitive plate, and this may be better explained on the principle of the pinhole camera, in which the rays of light from different parts of external objects passing through the pinhole form an

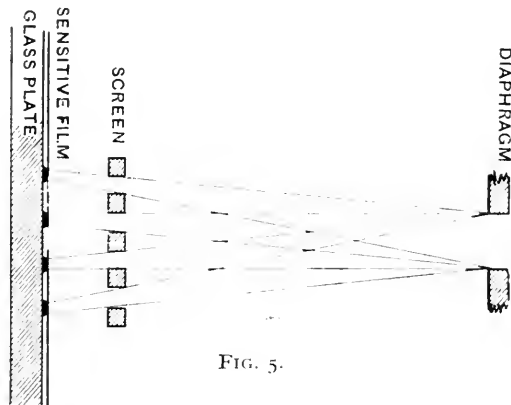

FIG. 5.

image at the back of the box. It does not require a great stretch of imagination to conceive each aperture in the network of the ruled screen as the front of a pinhole camera, and the sensitive plate surface as the back of this camera, whilst the spot of light formed by the opening in the diaphragm of the lens is, for the case we are considering, an external object to this pinhole, sending rays of light towards the latter, so that the spot is focussed on the sensitive plate, where it forms

an image which is afterwards developed to a black dot. Fig. 5 illustrates this action. That something of this kind actually does occur is proved by the fact that if the diaphragm opening is made square the dot is rendered approximately square, the same applying to any other form of opening which is sufficiently marked in shape to be readily distinguishable.

So far, then, the principle is intelligible and apparently obvious; but the weak point about it is that the production of larger or smaller dots to form the image is not explained. The reader will, however, quite understand that if, instead of any picture being presented to the lens, there was only a white sheet of paper, the dots would all be of the same size. Does it not, therefore, seem logical that if half the paper was covered with a black* sheet, the dots corresponding to this part would be small? Further, if another part of the white surface was covered up with something of a medium shade, neither black nor white—in fact, a half-tone—does it not occur to the reader that the dots would be of medium size?

That is practically what happens, but to assume this we must suppose that each dot starts with a nucleus which grows with greater and greater intensity of light or longer exposure. If we examine a negative under a powerful microscope we find that is exactly what does occur. Fig. 6 is a portion of a negative very greatly enlarged, and it shows clearly that each dot is, so to speak, a little mound or pyramid of reduced silver.

*Even black paper reflects some light, and therefore produces dot effect, the size of the dots being dependent on the relative intensity of the illumination.

It may be that there are other causes operating to assist in producing this effect—for instance, the natural tendency of the silver particles to communicate their action to neighbouring particles, and to spread the image according to the intensity of the light—an action due to what is termed irradiation; whilst there may be also causes acting in opposition to retard this action and produce sharply defined dots with clear spaces. Diffraction is known to have considerable action in that respect, but its phenomena are difficult to explain, and it hardly seems profitable to go into these bypaths of scientific speculation if the pinhole idea is sufficient to serve our purpose as a working principle.

Our conception of a pinhole camera naturally requires that there should be some distance between

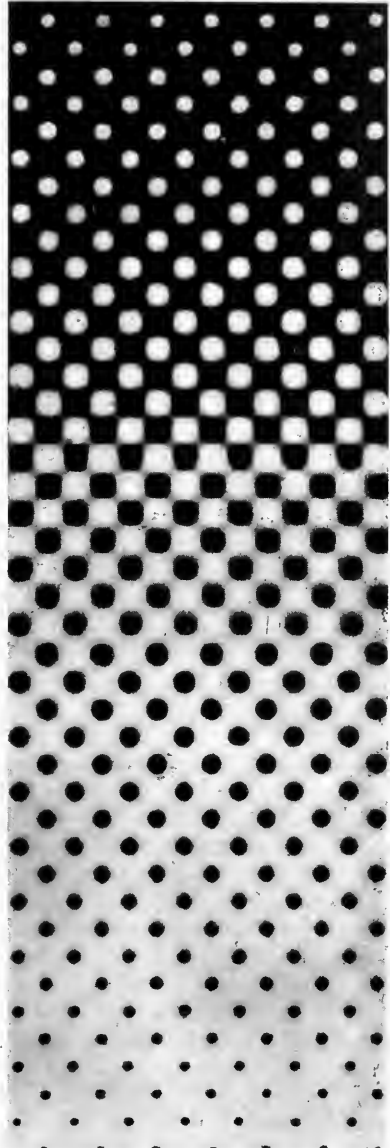

FIG. 6.—A Half-tone Negative greatly enlarged, showing the gradation from high lights (at top) to shadows (at bottom). In the print from a block the effect is reversed.

the pinhole and the receiving surface, and this we actually get in practice, for the ruled lines of the screen are on the inside of two glasses sealed together, so that there must be the thickness of the glass in any case, even if the screen is placed in close contact with the sensitive plate. As a matter of fact, it is found that some distance is desirable and even necessary, as, by varying the distance, the spreading of the dots and their ultimate sharpness can be controlled.

The problem is often considered by regarding the gradation of light in the penumbra of shadow formed by the edge of the screen openings. If the screen is at its proper position, and a suitable diaphragm is used there will be an increasing size of dot, as the intensity of the light reflected from any part of the picture increases. The diagram (fig. 6a) clearly shows it. Assuming light to travel in straight lines, then all the light from the whole of the diaphragm aperture can only reach the plate at P. As the light from shadow portions of the picture is not very intense, it requires all the light to impress even this small dot. From brighter portions of the copy light which does not proceed from the whole of the diaphragm aperture will leave an effect. Thus from the point A no light can reach the plate between point a^1 and b^1 , because the edge of the screen opening BC prevents it, but it can reach the plate everywhere between a^1 and c^1 , when it will have effect according to its intensity. The same is true for every point in the diaphragm aperture, so that from the brightest por-

tions a pyramid of silver deposit will be built up near its apex at P. This is absolutely demonstrable, because we may take high light dots, and print them for varying times. The centre will remain clear to the last, the dots gradually being printed from the edge inwards.

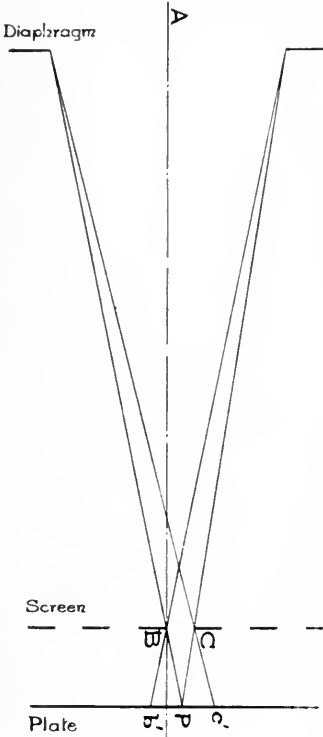

FIG. 6a.

It also follows, as a consequence of the pinhole idea (and also on the basis of the penumbral idea), that the size of dot must be to some extent governed by the size of the diaphragm opening, which, as we have shown, is the object the pinhole is photographing. Further, it must result that the size of the dot image must be determined by the distance away at which the spot of light is situated. In the same way the diaphragm opening governs the boundaries of the shadows thrown by the screen lines when we are considering penumbral action.

Mathematical calculations bear out the suppositions, showing that there is a correct distance for the screen for obtaining the best effect, and that it is governed by the size of the diaphragm aperture, the size of the screen aperture, and the focal extension of the camera. It is very soon found in practice that the stop may be

too large, so that it produces blurred dot images; or, on the other hand, the screen may be set too far away, so that the dots merge into one another, leaving no transparent spaces. Also, it will be found that, in the case where the stop is too small or the screen is set too close, the cross-line effect is obtained. The various rules for avoiding these abnormal results and obtaining the best effects will be described in later chapters, and we will proceed now to discuss the accommodation and apparatus required.

CHAPTER II.

THE SCREEN.

THE screens now universally in use are cross-lined with transparent squares between the intersections of the lines. Fig. 7 shows a portion of a screen of 200 lines to the inch greatly magnified. The edges

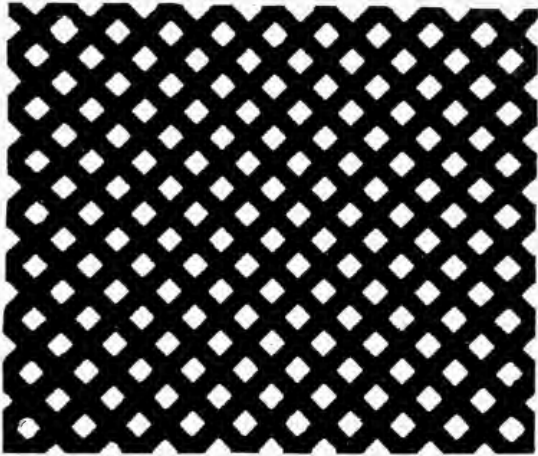

FIG. 7.

of good screens are sharp and clear under a magnifying power of 100 diameters. It was formerly the practice to use a single line plate, and to reverse the direction of the ruling by turning the plate a quarter revolution during the exposure, but this method is now obsolete.

Screens formed of circular dots instead of lines have also been tried, but abandoned by all practical workers.

Grained screens and "chess-board" screens offer more promising alternatives to the half-tone screen, but at the time of writing the latter have not come into commercial use.

The old plan by which the operator made his screens by copying the proof from a copper plate engraved with parallel lines has also been quite superseded, as also the clumsy makeshift of using wire gauze, silk net, muslin, crepe, or tulle.

The choice of a screen really becomes a simple matter, owing to the limited number of makers. Levy, of Philadelphia, U.S.A., is the oldest and most famous worker. Wolfe, of Dayton, Ohio, another pioneer American screen maker, is now dead, and his business has not been continued. There are two English makers of screens—Johnson and Brown, both located at Leicester; and in Germany there are also two makers—Haas and Illig, both in Frankfurt-on-the-Main. There is also a screen maker in Venice named Jacobi.

Levy screens have undoubtedly the highest reputation, and are the most extensively used throughout the world. Their quality and utility are beyond question. In the Levy screens the lines are engraved on the glass by means of a diamond point, set in an engraver's ruling machine, which accurately spaces the lines to any desired number to the inch. The cutting is done through an acid-resisting film, so that when completed the lines may be deepened by exposing them to the action of fluoric acid, which etches the bare glass away, leaving the parts covered

with the film untouched. The furrows thus formed are filled in with an opaque black pigment. Two single line plates, ruled in opposite directions, are generally taken and sealed together with Canada balsam, so that they form a cross-hatching.

Levy also makes what he calls "Economic" screens, which consist of lines ruled through a black film laid on the glass. They are not etched, and therefore the glasses cannot be taken apart and repaired, as in the case of the engraved screens. Except for this drawback, "Economic" screens serve just as well as the engraved kind; and, being half the price of the latter, they are largely used, and are found quite reliable.

Levy's "trial sizes," which are small pieces produced in cutting up larger plates, give the beginner a ready means of experimenting without incurring very great expense. The smaller sizes are in every way as perfect as the larger ones. Screen plates may be had from Levy from $4\frac{1}{2} \times 3\frac{1}{2}$, costing 10s., up to 40×32 , costing about £200. Levy does not adhere to standard photographic sizes, cutting his plates from large sheets to best advantage. Thus, a plate bought as 10×8 will be quite $10\frac{1}{2} \times 8\frac{1}{2}$, so that the full area of the photographic size may be taken in. As a rule, the excess measurement over the standard photographic sizes is half an inch each way.

The question of the size of screen to be purchased must be determined by the size of the camera and the means of its owner, for large size screens are very expensive. But the ruling is a matter which comes

within the author's duty to advise. By the ruling is meant the number of lines to the inch. In determining what is best the intending purchaser must consider what class of work he is likely to do.

Plates ruled with any of the following numbers of lines to the inch can be obtained :

50	75	100	133	175	300
55	80	110			400
60	85		140	200	
65	90	120	150		
		125	166	240	

The numbers printed in blacker type are standard rulings, and are generally either in stock or partly finished, so that these can be always obtained with greater promptness than those of exceptional textures.

Levy has produced rulings successfully up to 400 lines per inch, and it has been found that typographic blocks made even with this degree of fineness can be satisfactorily printed. (See example opposite page 28.)

For average work there is nothing better than 150 lines to the inch, which makes a good all-round screen, neither too fine nor too coarse. The 175 line screen is also coming very generally into use, the tendency being towards finer rulings as the quality of printing improves.

The following rough classification of the various purposes for which the different rulings are suitable will be some guide to the choice of a screen, the most commonly used rulings being printed in the above list in blacker type. A general rule to remember is that coarse screens give most contrast, whilst fine screens give greater detail in the reproduction.

	Lines per inch.
For large poster work	50, 55 , 60
, rotary newspaper printing, stereotyped ..	55, 65 , 75
, flat-bed quick newspaper printing ..	85 , 100 , 110
, photo lithographic transfers ..	110, 115, 120
, commercial, book and periodical printing	125, 133 , 140
, magazine and fine book printing ..	140, 150 , 166
, hand-finished fine catalogue engravings ..	150, 175
, microscopic reproductions and fine detail ..	200
, photogravure, heliogravure (intaglio plates) ..	240 , 400

With regard to the proportion of black to white in the ruling—that is to say, how thick the black line should be compared with the transparent space between—there was formerly much divergence of opinion, but Levy now rules his standard screen with black lines and transparent spaces of equal width, and he no doubt follows the general demand. Considering the diagram fig. 6a, it is seen that only screens ruled equally can give perfect gradation. A similar diagram made for a screen with wider lines or narrower lines will show that perfect gradation cannot be obtained with them.

It should be borne in mind in making any calculations based on the number of lines per inch that the figures give the “pitch” of the ruling—that is to say, the distance from the left-hand side of one line to the right-hand side of the next. The width of the line and the transparency space is accordingly half the “pitch” if the ruling spacing is equal. For example, if the screen is 100 lines per inch, the line or space will be $1/200$ th of an inch wide.

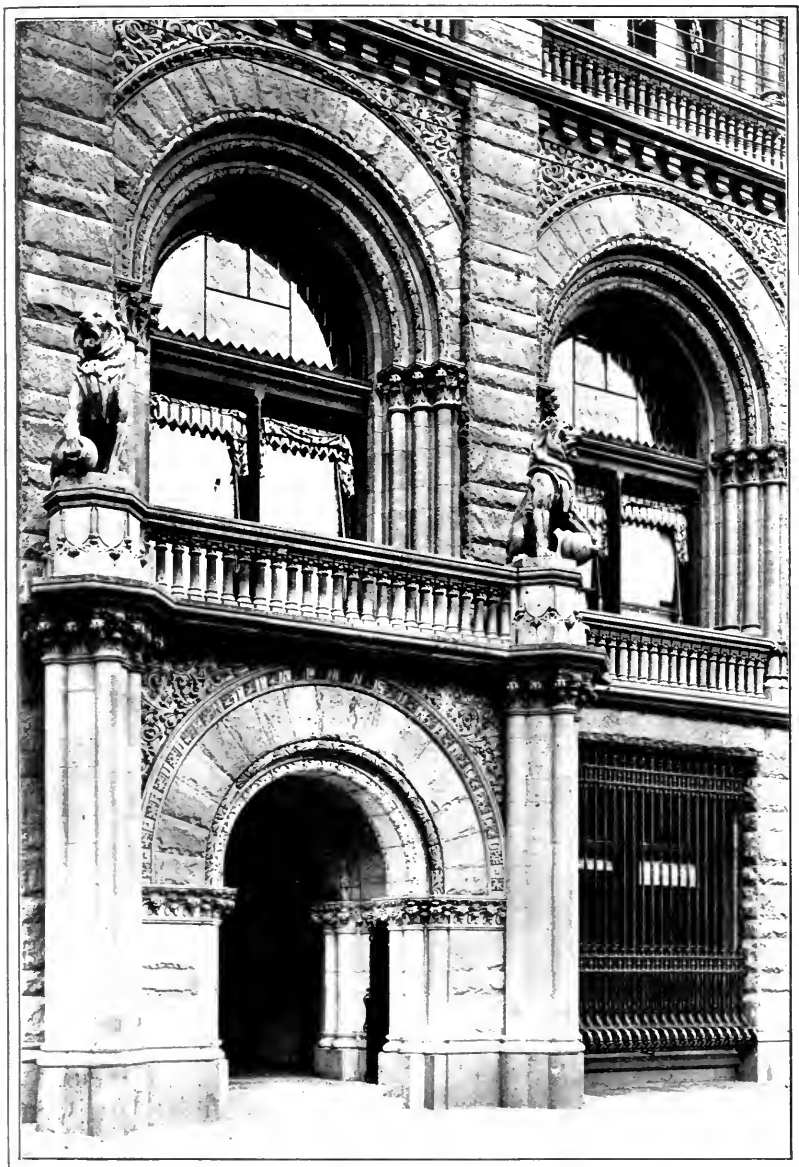

HALF-TONE MADE
WITH MAX LEVY'S
400 LINE SCREEN.

ETCHED ON COPPER BY
THE ENAMEL PROCESS BY
THE WALKER ENGRAVING
CO., NEW YORK.



A MODILLIO
DESIGN BY
G. S. LITTLEJOHN.

REPRODUCED BY THE BRITISH
PHOTO ENGRAVING CO., LTD.,
COVENTRY.

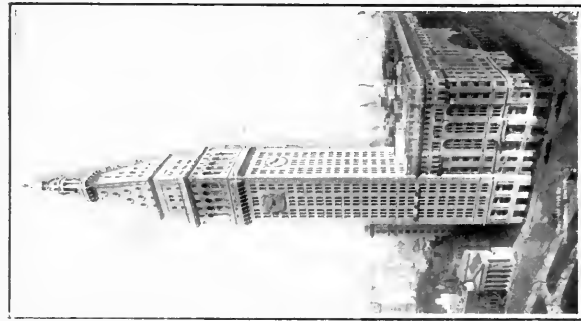

175 LINES.

EXAMPLES OF FINE GRAIN SCREENS WORK
FOR HIGH-CLASS PRINTING, MADE WITH
LEVY SCREENS.

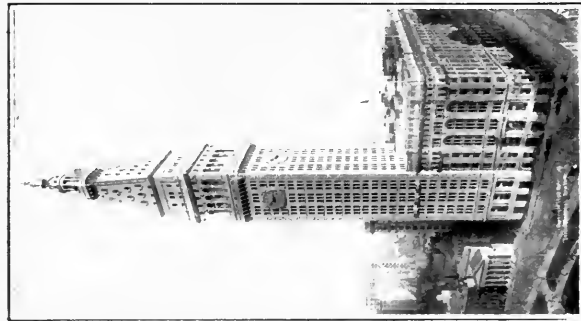

200 LINES.

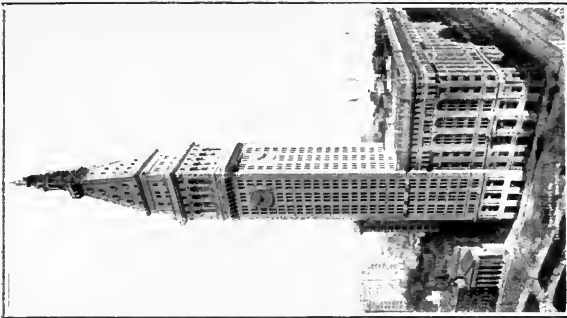

400 LINES.

ENGRAVED BY
THE WALKER ENGRAVING CO.,
NEW YORK.

A special screen for dry plate and emulsion work, with lines ruled wider than the clear spaces, has been recently introduced by Levy, though the standard screen rulings are quite satisfactory, and are mostly used.

Screens are usually ruled with the lines crossing at an angle of 45° to the sides of the plate, but for special purposes screens ruled parallel to the sides, or to any specified angles, are obtainable. The 45° screen has the merit of making the screen pattern least obvious to the eye on the finished print. A print produced from a screen with the ruling parallel to the sides will be somewhat harsh in appearance compared with the other.

Special screens for three-colour work are ruled at angles of 90° , or 60° and 75° , and when reversed these two latter screens give 120° or 105° . Such unsymmetrical plates are made with both sides as nearly as possible uniform in thickness, so as readily to admit of use in obverse and reverse positions to make two of the blocks for three-colour work. If three impressions from 45° screens were superimposed, as in three-colour printing, a peculiar wave or moiré pattern would be produced. If, however, absolute register were possible, there would be no moiré pattern, but a black and grey picture only. Hence the reason for choosing screens ruled at such angles as will obviate this. Circular screens are now made which can be turned to any angle, and are a great convenience.

It may be pointed out to relieve the beginner from any uneasiness as to the quality of his screen that in

producing these screens it is impossible to avoid occasional small specks and bubbles inherent in all glass. These defects do not in any way affect the working quality of the screen, and though they are perceptible in the smooth unbroken tint of the screen, they frequently do not show at all in the resulting work. Where they do so they can be remedied by a touch of the graver in the hands of a finisher. The defects that occur from such small faults are of utter insignificance compared with those which occur through one or another extraneous source in the chemical manipulations.

Screens should be put away in a preserving box when out of use, and, being valuable, it is just as well to have them under lock and key to prevent accidents from meddlesome hands. The surfaces should be kept perfectly clean, and in polishing care should be taken to avoid scratches. A very soft piece of washleather, an old cambric handkerchief, and a piece of soft tissue known as "papier Joseph," are things which suggest themselves as best to polish with. Max Levy recommends China silk. A little iodine in ether and alcohol, or a little dilute ammonia, may be used to remove greasiness. Whiting, rouge, or other polishing powders should not be used. Another detergent consists of a solution of three ounces of acetic acid and three ounces of absolute alcohol. A few drops should be poured on the screen and rubbed about with a tuft of cotton-wool, then cleaned off with papier Joseph and polished with a silk rag. It must be borne in mind that a dirty screen will

never give good results. When screens are used in the dark slide care should be taken that the edges do not get wetted with silver solution, otherwise it has a way of creeping in between the glasses, injuring the cementing, and giving a yellow stain. Beeswax or paraffin wax rubbed on the edges of the screen will tend to prevent silver solution soaking in.

Levy has recently made his screens much more durable by binding the edges with an aluminium frame.

Care must be also taken that the screen is not placed under any strain. It should not be "jammed" tight in its holder in the camera, nor when out of the camera should it be stood on end, leaning against the wall, or the outer glass may slide out of place in a hot studio through the cement softening.* There is no objection to standing them vertically in a rack. It is, however, best on the whole to put the screen away in a horizontal position between soft pads of cotton. Operators should avoid the practice of warming the screen, as is sometimes done to prevent the condensation of moisture on it from the wet plate in cold weather. The same effect may be obtained, as a rule, by rubbing a little glycerine or wax on it and polishing off, or by keeping a hot water bottle painted dead black or covered with a cloth inside the camera. A coating of gelatine applied overnight and allowed to dry is an effective preventive of sweating. The coated side of screen is placed next the plate.

* This difficulty does not occur with the latest type of Levy Screen which is framed with aluminium.

It is one of the particular features of the engraved screens that if they become scratched, stained, or unsealed, or partially broken, they can be sent back to the manufacturer for repair at a nominal expense, and will be returned practically equal to new. Where one glass only is cracked, another can be matched to it, or where both glasses are broken at perhaps one corner, the screen can be cut down. "Economic" screens cannot be repaired in this way.

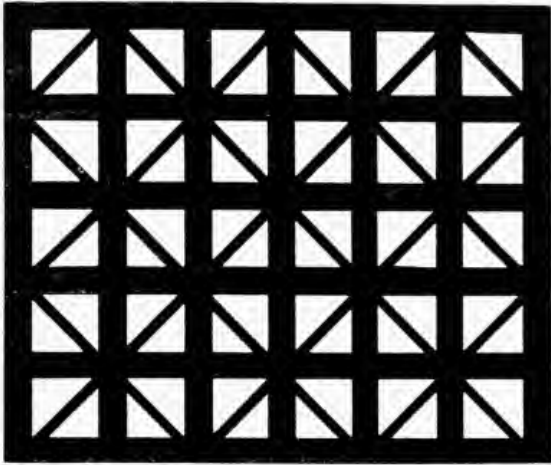
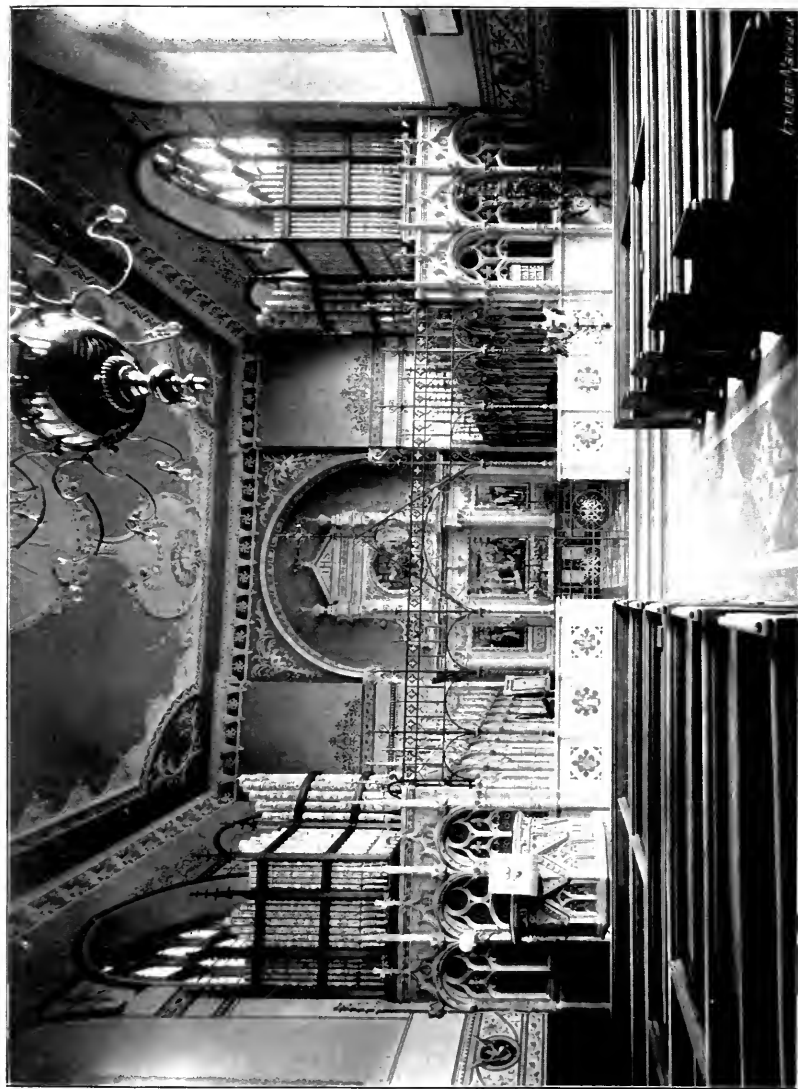

FIG. 8.

Attempts have been made to rule screens which will break up the grain with less mechanical regularity. Levy has taken out a patent for such a screen, in constructing which there are four sets of lines, instead of two as in the ordinary cross-line screen. Fig. 8 is an enlargement of such a screen. On each of the two glasses forming the screen is ruled a separate network. On the one glass the net-



Block by
Etablissements Jean Motteux,
Brussels - Orest.

S. NICHOLAS, BRISTOL.

HALF-TONE NEGATIVE MADE WITH LUVY'S FOUR-LINE SCREEN.

Photo by Chas. H. Horton.

work is comparatively open and the lines thick, and it is ruled parallel to the sides of the plate. On the other glass the network is ruled at 45° to the sides of the plate, and the lines are thinner. The two glasses are cemented together in such a way that the network of 45° cuts across the corner of the squares formed by the other glass. The result is the formation of groups of dots of irregular shape and size, so far as the elements of a group are concerned, but the groups are repeated geometrically. Yet such is the action of the light when the photographic image is passing through the screen that the mechanical continuity is broken. A greater amount of detail and better colour values are said to be secured, but this claim is disputed by some workers.

Levy, however, announces now that, owing to the great difficulties of producing these screens, and the slight demand for them he has abandoned their manufacture.

Mr. W. Holt introduced a screen giving a similar effect to the four-line screen, and there have been one or two attempts on the Continent to popularise new patterns of screens, but without success.

The fact is that if such abnormal dot patterns are required they can be produced by means of diaphragms with multiple apertures combined with suitable setting of the screen distance. A great many processes of this kind have been described and published, but none have come into regular commercial use.

A screen ruled with lines crossing at 60° (fig. 9) instead of 45° has been patented by A. Schulze, and

it is claimed that, in conjunction with suitable stops, it renders better tone gradation.

A wavy line screen has been invented by A. Dargavel, which for portraits gives an appearance of



FIG. 9a.



roundness or contour to the features. This screen has only so far been used for coarse newspaper blocks, for which it seems to have some advantages. Fig. 9a is an enlargement of the lines of one of these screens.

A wave screen has also been introduced by J. E. Johnson, but he adopts a much longer wave.

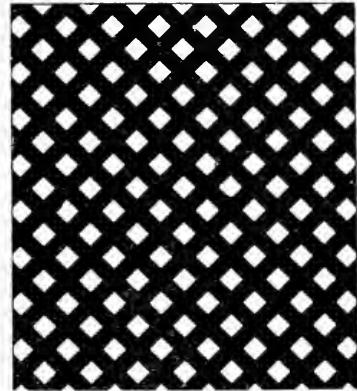

FIG. 9.

What are called irregular grain screens have been introduced of late years and for certain classes of subjects, or as a pleasing variation from the monotony of the ruled screen, they are coming into use.



HALF-TONE WITH
DARGAVEL'S
WAVY LINE SCREEN.

BLOCK BY
JOHN SWAIN AND SON, LTD.

As commonly understood, irregular grain screens are produced by depositing on a glass plate an opaque powder in such a manner that transparent spaces of varying size will be left between the grain points. Another way is to flow the glass plate with an opaque varnish so compounded that it splits up on drying into a reticulated grain. To give such screens a greater degree of permanency they have been etched and filled in with black pigment in the same way as the ruled screens, the grain first formed being of an acid-resisting nature.

Such screens cannot be regarded as acting in the same way as a ruled screen. They are placed as close as possible to the sensitive plate, the use of a cover glass not being permissible, and each grain point must be considered as an opaque obstruction to the light. The image spreads more or less according to the intensity of the light, so that in the highest lights all but the portions under the largest opaque obstructions are filled up, whilst these are closed to such an extent as to produce a very fine dot. A very small stop and long focus lens has to be used in order to restrain the spreading action.

A more promising kind of irregular grained screen, having, moreover, some peculiar optical features, is the Metzograph, invented by Mr. Jas. Wheeler. It has absolutely no opaque grain on it, presenting to the naked eye simply the appearance of a piece of ordinary transparent glass. On examination under magnifying power, and at a suitable angle to the light, it is seen that the surface is covered with prismatic

reticulations, the character of the grain being in many respects similar to collotype (fig. 10 is an enlargement of the grain on the surface of the screen).

It is stated that the process of production of this screen consists essentially in the sublimation of pyrobetulin, which, being deposited on the glass

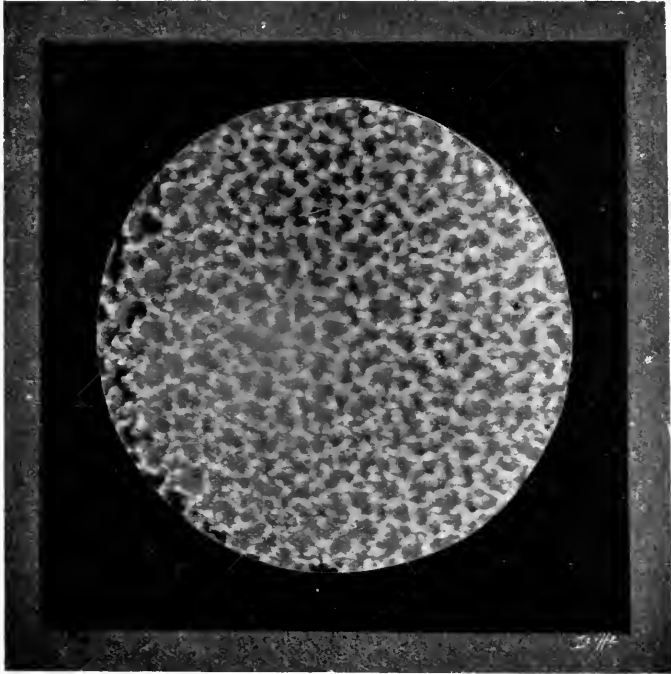
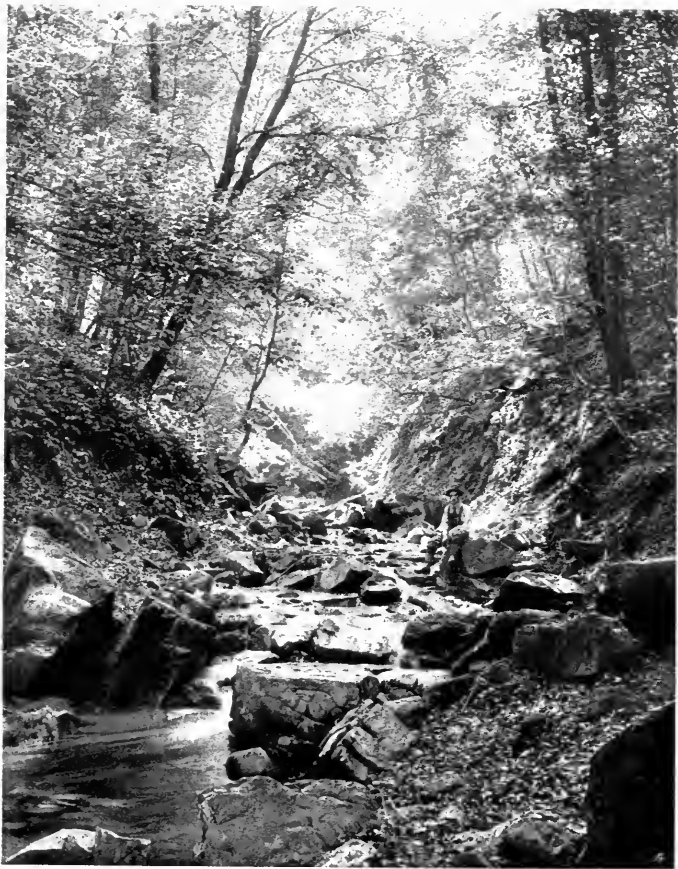

FIG. 10.

in a reticulated film of any desired fineness, is afterwards treated with hydrofluoric acid, whereby a like character of reticulation is imparted to the glass itself. The effect of the prismatic reticulations is to divert a portion of the light which reaches the screen, causing alternate light and dark



EXAMPLE OF WORK
DONE WITH THE
METZOGRAPH SCREEN.



spaces which have consequently the same effect as opaque obstructions, but without the harshness which the latter seem to impart. The inventor of the screen claims that every tone of the picture will exert a different selective effect on the grain, and, consequently, a truer naturalness of texture and gradation is secured. The procedure for the production of the negative is similar to that followed with the lined screen, but the plate would require an exposure not exceeding one-sixth of the time necessary with a lined or pigmented grain screen if an equal sized stop were used in both cases. As, however, a small stop has to be used, the exposure is practically as long as with the cross line screen. Generally speaking the screen must be placed as close as possible to the sensitive plate.

Of course, for all ordinary work the usual cross-line screens will no doubt long remain in use, but advanced workers will very probably take up the interesting work of utilising these new screens.

CHAPTER III.

THE STUDIO : ITS CONSTRUCTION AND EQUIPMENT.

ANY studio built for photographic work will suit equally well for copying for the half-tone process ; but where electric light is available any ordinary room of sufficient size may be used, and it is quite unimportant on what floor it is situated. In London and other large cities, process studios will be found in dark basements and all kinds of upper floors, the daylight being in many cases blocked out altogether.

There can be no doubt that there is nothing like good daylight after all for photographic work, but, unfortunately, it is not usually constant enough to suit the commercial requirements of half-tone work, which must be produced at all times of the day and night for illustrated newspapers. Most large firms who have studios outside the city compromise the matter by having them arranged for the use of both daylight and electric light, and undoubtedly this is the best practice, as daylight can be employed almost exclusively during the summer months.

There is frequently great difficulty in lighting large originals, and especially coloured originals, with the usual pair of arc lamps, where there would be no difficulty with daylight.

If it is necessary to build a studio, it is most essential to determine, first of all, what size camera will be worked, and what is the extreme reduction likely to be required. Then, if the focus of the lens is known, the minimum length of studio can be estimated from the following table, which is based on the focus of lenses usually in use for cameras of from 12 × 10 to 24 × 20, the camera being placed for direct copying without prism or mirror :

Focus of lens.	Distance from original to ground-glass when copying to the following scales :			
	$\frac{1}{1}$	$\frac{1}{2}$	$\frac{1}{4}$	$\frac{1}{8}$
Inches.	ft. in.	ft. in.	ft. in.	ft. in.
12	4 0	4 6	6 3	10 1 $\frac{1}{2}$
14	4 8	5 3	7 3 $\frac{1}{2}$	11 9 $\frac{3}{4}$
16	5 4	6 0	8 4	13 6
18	6 0	6 9	9 4 $\frac{1}{2}$	15 2 $\frac{1}{4}$
20	6 8	7 6	10 5	16 10 $\frac{1}{2}$
24	8 0	9 0	12 6	20 3
30	10 0	11 3	15 7 $\frac{1}{2}$	25 3 $\frac{3}{4}$

It may be taken as a general rule that it is seldom that reductions below quarter size are called for, and it is a good plan to base one's calculations upon this limit, as one can put a shorter focus lens on the camera to deal with smaller reductions.

If we reckon two feet over and above the distance from the original to ground-glass we get the overall dimensions of the swing or copying stand, and it is generally necessary to allow a gangway of at least three feet at each end for walking round, so that on the whole it may be taken as a rough and ready rule to add eight feet to any of the above distances for

quarter size reductions to arrive at the size of studio suitable for a given lens.

Take the case of a lens for 15×12 work, which will be 18in. to 20in. focus, the studio length will be from 17ft. $4\frac{1}{2}$ in. to 18ft. 5in., according to our rule, and from the latter length up to 20ft. will be found to be the space allowed for a 15×12 camera in most good studios. Swings or stands for 15×12 cameras are usually made 12ft. long.

The next consideration will be the width of the studio. Here it must be borne in mind that it is necessary to work with a mirror or prism for reversing the negatives; consequently the camera must be placed across the swing or stand. If we have not the camera at hand to measure, we may take it that the base will be at least twice the focus of the lens. A 15×12 camera will generally have a base length of 4ft., and as we must have plenty of room to walk past the camera at each end without pushing against it accidentally during an exposure, we would set down as a rule that one cannot work a 15×12 camera in a space less than 6ft. wide.

From the foregoing considerations it will be seen that the least floor space for a single camera of 15×12 size is 18ft. \times 6ft. When two cameras are worked together, it will be found that less than 12ft. width will do, as they can have a common gangway between.

In the matter of height there is no rule to observe, but it is well to remember that a fairly lofty studio gives better ventilation, and can be maintained at a more equable temperature. If it is intended to work



FIG. 11.—The Binner Co.'s Sunlight Studio.

the electric light as well as daylight, it is necessary that the studio should be rather high, in order to sling the lamps well above the camera. Overhead traversing gears are usually not manageable unless placed at a height of 10ft. or 12ft. from the floor.

If daylight is used, it is naturally best that the lighting should come from the north, though any other position could be made use of with the aid of blinds to shut off any direct sunlight which might be likely to cause uneven illumination.

The Binner Engraving Co., in Chicago, however, have what they call the "Sunlight Studio," in which they allow direct sunlight to fall on the originals. Fig. 11 is a view of this studio, which is a typical American one with good features.

Perhaps the best form of studio is one with a top light inclined towards the north, and also with glass at the east and west sides, the south side being closed and the copyboard being placed next to it. At the north end may be the dark room under the ordinary roof. If side light cannot be obtained, the walls of the studio should be whitened, or white screens set up at each side. Diagrams are given of three styles of studio construction (figs. 11a, 11b, and 11c), and a ground plan of a studio and dark room for one camera (fig. 11d).

It is not necessary to carry the glass on the roof the whole length of the studio ; it is, in fact, better that the end of the studio where the camera is placed should be in comparative shade, so that the focussing may be done with ease.

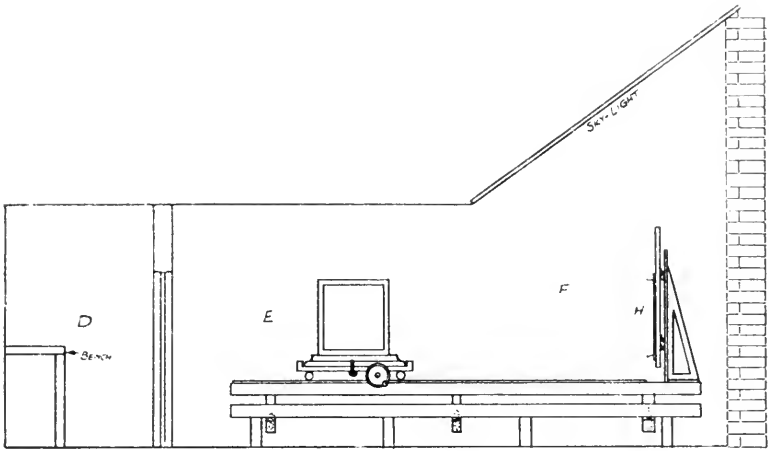

FIG. 11a.—Section of a Studio for North Light.
D is the dark room, E the camera, F the stand, H the easel.

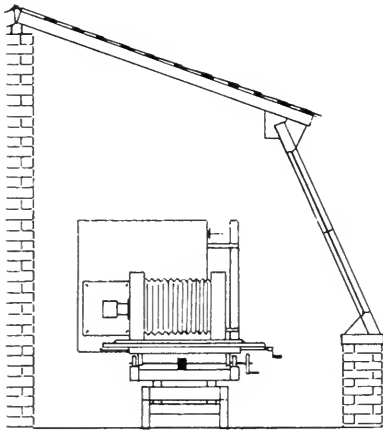

FIG. 11b.—Side-light Studio.

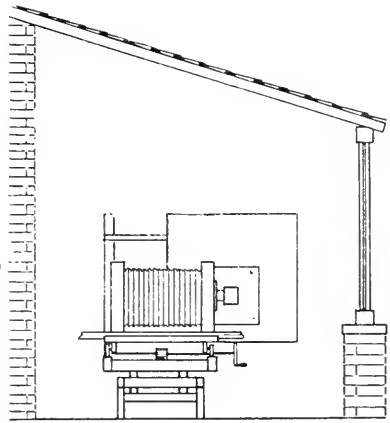

FIG. 11c.—Lean-to Side-light Studio

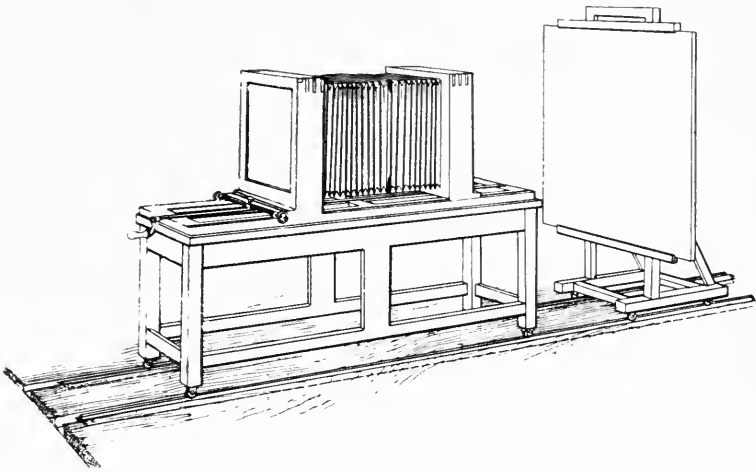

FIG. 11.—Camera Stand and Easel on Floor Rails.

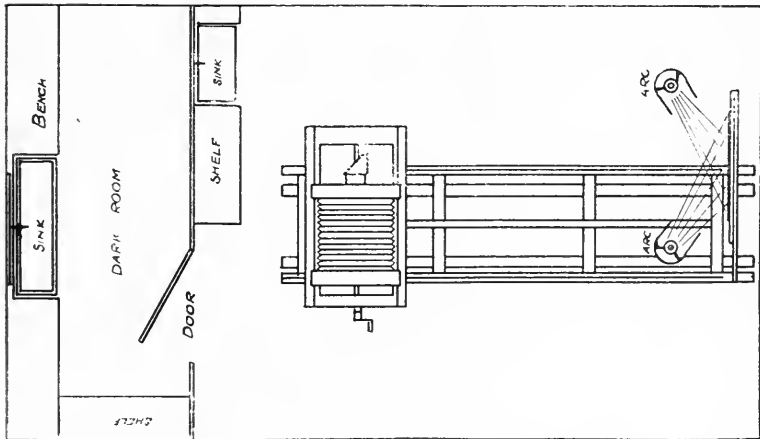

FIG. 11e.—Plan of Studio and Dark Room for a Single Camera.

The studio should be solidly built to prevent vibration, though this may be overcome, as will presently be shown, by swinging the camera base or supporting it on springs. The beams supporting the roof should be strong, especially if the electric lamps and camera base have to be swung from them.

It is a mistake to assume that the best place for a studio is at the top of a building. Whenever space can be spared, it is best to have it on the ground, the floor being laid with concrete under the camera stand.

In some studios the camera is placed on a table stand with grooved wheels running on rails, and the copyboard either rigidly fixed against the wall or provided with a stand and grooved wheels to run on the same rails (fig. 117e). It is not easy to secure parallelism with this arrangement, unless the camera stand is provided with a levelling arrangement, and the copyboard with adjusting screws. Unless there is an entire absence of vibration this separation of the support of camera and copyboard will give trouble, owing to the two vibrating unequally. With the two joined by a long base there is a certain amount of springiness, and a tendency for the whole to vibrate together, and it is obvious that if the ground-glass and the copyboard are vibrating together, or, so to speak, in "step," there will be no evidence of movement of the image on the ground-glass, which, if present, would cause blurred and unsharp images.

It is for this reason that the plan of swinging the camera base with ropes or supporting it with springs is resorted to, as we shall describe when we deal with the camera and its accessories.

In some studios the dark room is made to take the place of the camera. The lens is placed in a shutter fixed in a hole in the wall. An easel carrying the copy runs on rails in the studio, and another easel to carry the sensitive plate runs on similar rails in the dark room. This arrangement has certain conveniences for large work, but for small work it is objectionable.

A good bench or table in some part of the studio, especially just outside the dark room, is a convenience if space is available, as this can be used for glass cleaning and other operations requiring a good light. But it is desirable that no other operations than those appertaining to the taking of negatives should be performed in the studio, and the less it is lumbered up with odds and ends the better it will be for the cleanliness and comfort of working.

Provision must be made for warming the studio in winter, and for keeping it cool by proper ventilation in the summer time. An electric fan is very good for the latter purpose.

In some cases it may be possible to get hot water pipes through the studio, but in case this is not available a good gas stove is a convenient and cleanly means for warming. A coke stove is rather objectionable on account of dust created. Closed stoves for burning anthracite are, however, excellent. An oil stove is a good substitute for a gas stove. Electric radiators are coming into use, and are not any more expensive to buy or to use than gas stoves, whilst, as the electric supply is to be found in nearly every studio, the radiator is easy to install. Most electric

supply companies give a special rate for current required for heating purposes.

The studio having been arranged on some such lines as we have suggested, we must next consider its equipment with suitable apparatus.

SCREEN AND PLATE HOLDERS.

The primary consideration is the camera and its accessories. In the early days of the process it was usual to take any ordinary camera of good square pattern—preferably one that has been constructed for copying—and make some provision in the dark slide for holding the “screen” in front of the sensitive plate. If the dark slide was not deep enough a new one was made with the recess for the plate at least double the usual depth. The “screen” was then placed in, and a strip of cardboard or thin wood such as printers’ reglet introduced round the margin so as to prevent the plate touching. The ground-glass had, of course, to be correspondingly set back in the focussing frame to agree with the position of the sensitive plate. An obvious disadvantage of this method was that any alteration of the screen distance, by putting in thicker cardboard strips, would put the plate out of focus, unless the ground-glass was correspondingly altered.

This difficulty was overcome by dividing the plate recess into two portions, as in the case of the double back of an ordinary camera. The division was effected by means of a thin silver plate or wire placed diagonally across the corners (fig. 11f). The sensitive plate was then laid on one side of the division and the screen on

the other, springs generally being provided to prevent the screen falling out. If any alteration of the screen distance was required, a piece of cardboard could be laid between the screen and the corner wires. Different

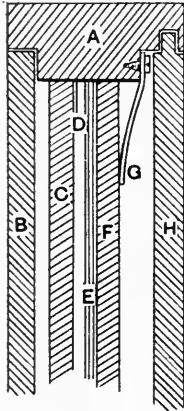

FIG. 11f.

- A—Framework of dark slide.
- B—Back lid of dark slide
- C—Plate carrier.
- D—Wire corner.
- E—Cardboard separation.
- F—Screen carrier.
- G—Spring.
- H—Shutter.

sizes of screens can, of course, be placed in carriers in the same way as the plates. Screens are usually $\frac{3}{16}$ in. thick, and in making a dark slide it is well to allow twice this depth for the screen carrier, so that an adjustment up to $\frac{3}{16}$ in. may be obtained by the insertion of thicknesses of cardboard. It is better that the latter should be cut out like the mask of a lantern slide, and the thickness a definite fraction of an inch, say $\frac{1}{32}$ in. or $\frac{1}{64}$ in., so that the combination of any number of these would give any pre-determined screen distance, which could, moreover, be accurately repeated at any time.

A dark slide arranged on the foregoing lines would be regarded in these days as a makeshift in any up to date establishment ; nevertheless, it will suit very well for a beginner, who wishes to be very economical in his expenditure on apparatus.

A step better is to have a "screen and plate-holder," in which there is some mechanical means of adjusting the screen, and thus dispensing with the cardboard packing.

Max Levy was the first to devise a successful holder of this kind for use with his screens, and the same, or

modifications of it, are largely used in America to this day. The Levy holder practically doubled the form of wet plate-holder known as the Benster or Bonanza, which was, and still is, very popular in America. The feature of this form of holder is that carriers are dispensed with, the plate being held between two bars, which grip it like a vice. The bottom one is usually

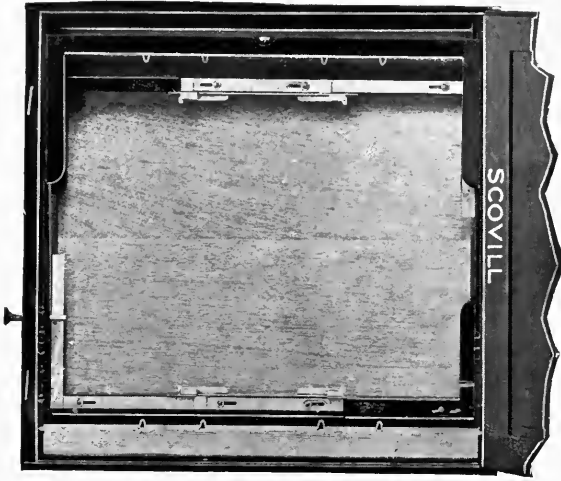

FIG. 12.

in notches at each side of the holder, corresponding to the bottom edge of the different sizes of plates, and the top bar slides down until it rests on the top edge of the plate, as shown in the illustration (fig. 12).

This is known as the Scovill-Levy holder.

In some forms of this type of holder the bars have had attached to them a rack, so that a central pinion at the side would feed them up and down equally. Anthony's holder (fig. 13) is on this principle. In

another pattern there is a rod at each side with a right and left-handed screw cut on it, so that when engaged with a nut on the bars they move to and fro equally. These complications are, however, quite unnecessary, and are even objectionable where the wet plate process is worked, as the mechanism gets rusted or corroded.

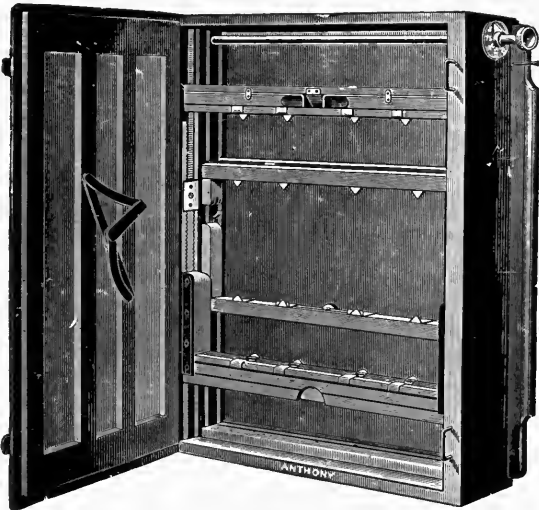

FIG. 13.

For half-tone purposes two pairs of bars are provided, working independently of each other, one pair thus holding the screen and the other the plate—the screen, instead of resting directly on the bars, is held in clips attached to them. In the early forms of this holder these clips were attached to a sliding bar, which, when pushed one way or the other, altered the distance of the screen. The disadvantage was that either two or four corners had to be shifted separately, and it was not easy to get the screen quite parallel,

whilst the adjustment could only be done when the slide was open and apart from the camera.

Penrose and Co. improved on the idea by introducing a holder in which the screen was adjusted by turning one knob on the outside of the holder, and



FIG. 14.

the distance moved was shown by a pointer working against a divided scale plate. Two forms of this holder are made, one comprising the smaller sizes from $6\frac{1}{2} \times 4\frac{3}{4}$ up to 12×10 with ordinary carriers for dry plate work ; and the other on Levy's principle, with the double pair of bars, for wet plate work, from 10×8 to 24×20 . Such a holder could be attached to any ordinary camera, and forms a very efficient apparatus for half-tone negative making (fig. 14).

In the smaller sizes of these holders a ground-glass frame is attached by folding hinges, so that the back of the holder may be opened and the glass swung into its place, the front shutter being drawn, and the holder becoming to all intents and purposes a focussing screen (fig. 15). In the larger holders a piece of ground-

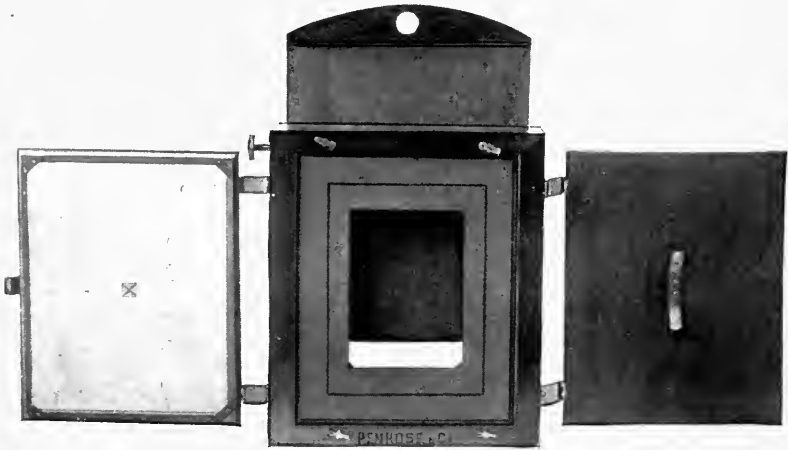

FIG. 15.

glass is placed in the holder, and the roller shutter in front is made to wind up into the top of the holder, so that in this case also the focussing may be done.

SCREEN ADJUSTMENTS.

All these methods must be regarded as more or less makeshifts, which are not in any way comparable for convenience with the plan which has now become very popular—in Europe at any rate—of holding the screen, independently of the dark slide, in a frame which can travel to and fro in the back of the camera, thus enabling the screen to be racked into position after

the dark slide is inserted. Penrose and Co. patented this idea about 1894, and their system has been extended and elaborated, so that it now forms a very perfect mechanism for holding and operating the screen. The apparatus (fig. 16) consists essentially of a frame carrying a pair of adjustable bars to hold the screen, in a similar manner to that of the dark slides

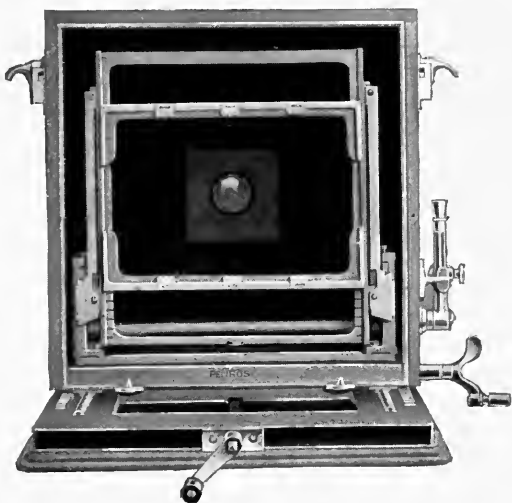

FIG. 16.

already described, this frame being attached to a pair of accurately fitting iron slides, running in brackets fixed at each side of the interior of the camera. The slides are operated by levers at each side, set in motion simultaneously by a rod, to which they are fixed, passing through the camera, and having on its outside end a lever for working it. This lever is sometimes provided with a micrometer screw for obtaining a slow and fine movement, and also affording a stop against which the lever can be returned without

resetting. A pointer projects from the inside travelling frame and indicates its position on a scale plate outside. This plate is usually marked off with two scales, one reading in millimetres and the other in $\frac{1}{32}$ nd parts of an inch.

It is thus possible to set the screen very accurately to any determined distance from the sensitive plate, and the advantage is that the screen is kept safe against accidents, which may easily result from carrying it so often to and fro, and from manipulating the holder in the dim light of the dark room. Further, the screen may get scratched by the corner of the sensitive plate coming into contact with it, or just at the moment of inserting the plate a drop or splash of silver on to the screen necessitates taking it out and cleaning. But a worse trouble is that the silver solution which drains from the plate is apt to creep up between the sealed glasses of the screen by capillary attraction, not only causing a yellow stain thereby, but disintegrating the Canada balsam used for sealing, and causing the glasses to separate. It is impossible to use the part of the screen thus affected, and the only remedy is to send the screens back to the maker for cleaning and resealing, entailing long delay.

The side lever screen gear has now been almost superseded by the Centric screen gear (fig. 17). In this case the screen holding frame rests on sliding ways, and is pulled to and fro by a central lever. The screen distance is read off on a sloping scale in front of the operator. The screen holding frame is made entirely of aluminium, and other features added are

adjusting screws to reset the screen holder if it should get out of parallelism ; also locking screws to the top bar to prevent it lifting accidentally and permitting the screen to fall out. Further, each bar is fitted with



FIG. 17.

a spring clip to press the screen against the front stop, no matter what the thickness of the screen may be.

Several other makers have constructed screen adjustment mechanisms for the back of the camera, their essential points of difference being in the slides for guiding the movement and the means of operating it.

Linley's system is perhaps the best known. It consists of placing a single dovetailed slide, like the slide rest of a lathe, in the bottom of the camera body, and erecting the screen holding frame upon it. The slide is moved by a central lever attached to a link under the slide. This will pull it to and fro with a quick movement, whilst a micrometer screw operating against the sliding piece provides for a slow and fine movement.

Klimsch uses a similar slide, but operates it by a horizontal linked lever from the side.

Hunters have a similar screen gear, but it is pulled to and fro by a rack operated by a horizontal lever having on the end of it the segment of a toothed wheel.

Voirin adopts the same form of slide, but operates it by a horizontal linked lever.

Falz and Werner use the base plate slide in much the same way, and operate it by a pinion rod, with a lever and tangent screw on the side of the camera.

Watson arranges a pair of bevelled cog wheels in each of the four corners of the screen holder, and operates these simultaneously by means of connecting pinions ending in a knob on the outside of the camera.

The principle of a pair of wedges sliding parallel to each other, and also the principle of the parallel rule, has been used ; also cams to push against the four corners of the screen frame. Various forms of lever movements have also been adopted.

Still another variation is a sliding wedge-shaped strip which is pushed in and out.

There is probably not much scope now for any really new method of screen adjustment, so many notions

having been tried. Most of the attempts to improve on the original idea have been with the object of ensuring exact parallelism and freedom from risk of going wrong. One principle is common to all screen movements, viz., that there must be a quick to and fro movement, and a fine slow adjustment, each acting independently.

THE CAMERA.

The camera in other respects is an ordinary camera, except that it is necessarily more bulky on account

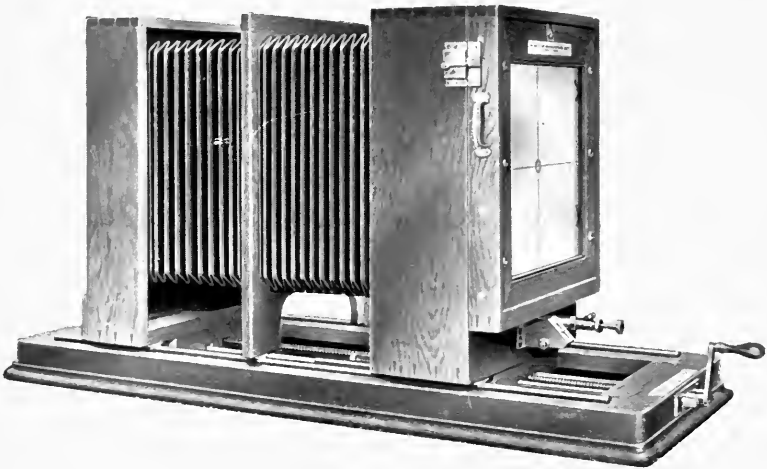

FIG. 18.

of holding the screen gear, and it must be made very rigid and parallel in all respects. The moving parts for focussing should run on metal slides, and there should be no side play, nor should the bodies rock vertically. The base should be in one length and proportionately thick to ensure freedom from bending when the weight of the bodies is on any particular part.

A camera with both front and back bodies moving is an advantage, especially when working extreme reductions with a large camera and a short focus lens. If the front body was fixed in such case, there would be a long stretch of tailboard to lean over to get to the focussing glass. Figs. 18-18a illustrate a popular type.

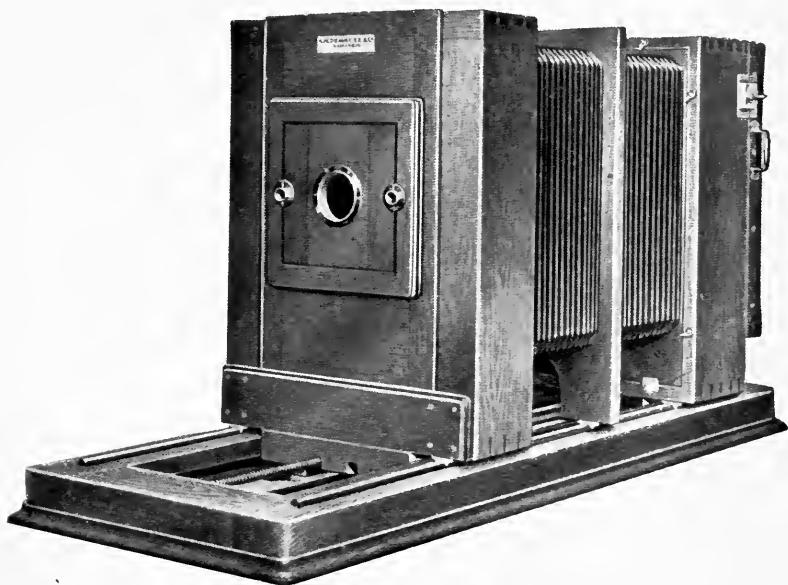

FIG. 18a.

A camera with the back body fixed and with the front body moving is difficult to focus, as the copy or the whole camera must be moved at the same time.

The best arrangement of all is to have a camera with both the front and back bodies movable. The front may be operated by a screw and the back by a pinion, or both may be operated by screws, thus keeping the control of the movements to the back of

the camera. An arrangement for raising and lowering the front by some means, also from the back of the camera, is a further convenience for centring the copy, and the plan of having all the manipulations operated from one point may be extended to the luxury of having an additional lever to shift the lens board or the copy board laterally, and a mechanism for capping the lens and changing the diaphragm.

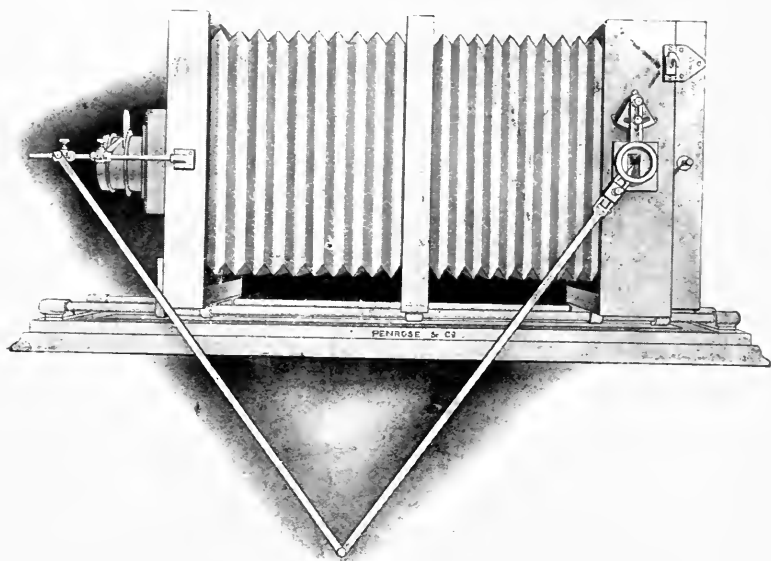

FIG. 19.

Attempts have been made to devise automatic methods of adjusting the screen, or of indicating its correct position, proportionately to the extension of the camera. Whilst such an automatic apparatus is quite a possibility, and has been patented in two or three forms, there is not at the time of writing any apparatus on the market for the purpose, the fear being pro-

bably that the apparatus would prove too complicated to be useful. A most promising idea of this kind is an apparatus invented by Mr. Ray, of Calcutta,

which seeks only to indicate the correct position of the screen, so that the operator may set it himself without having to think about the matter.

The apparatus (fig. 19) consists of a pair of rods of equal length, looking very much like half of a pantagraph parallelogram. One of the free ends of these two rods is attached to a point opposite the sensitive plate, and the other to a point opposite to the diaphragm of the lens. A pointer placed on the rear rod then indicates increase or diminution of the screen distance proportionate to the extension or closing up of the camera.

Mr. Howard Farmer has devised what he terms an autofocal system, which indicates the exact screen distance in proportion to the screen ruling, the size of diaphragm, and extension of the camera. There is no automatic mechanism, the screen lever having to be set according to the indications of a scale at the side

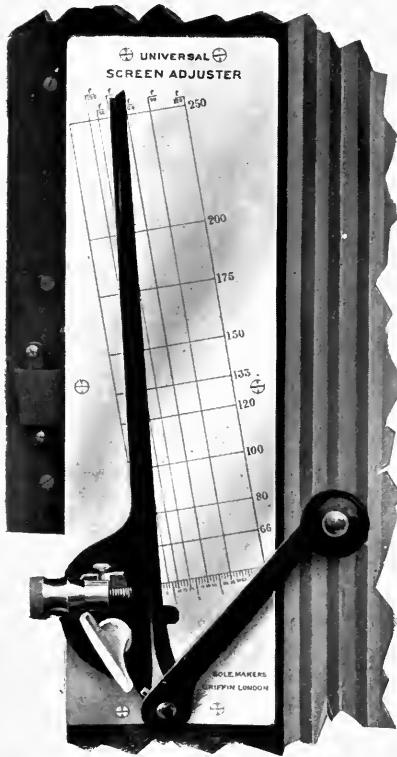

FIG. 20.

of the camera (fig. 20). Fig. 20a is an indicator worked in conjunction with the former for showing the size of diaphragm opening.

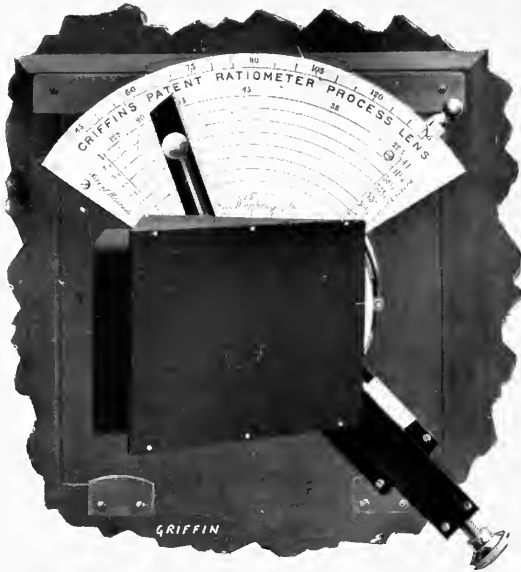

FIG. 20a.

THE CAMERA STAND.

Next in importance is the base and copyboard. Whether this should be in the form of a swing or a rigid stand depends on the nature of the premises. If the studio is at the top of a lofty building, or, indeed, on any upper floor, with machinery in the basement or on the lower floors; or if it is situated near a railway or busy thoroughfare, so that a great amount of vibration is caused, it is necessary that the camera and copyboard be suspended on one bed frame from the beams of the roof, or swung, cradle-fashion, from springs supported by a rigid stand. If the studio is situated quite away from any vibrating influence, a rigid stand on a concrete floor is best and most con-

venient to use. On a wooden floor it is possible to minimise vibration by placing thick rubber or felt pads under the feet of the stand.

Fig. 21 illustrates a swing of the usual form. Some workers attach the upper ends of the four ropes to a beam which is swung at its centre, like a scale beam, from a single hook in the ceiling. This, the author

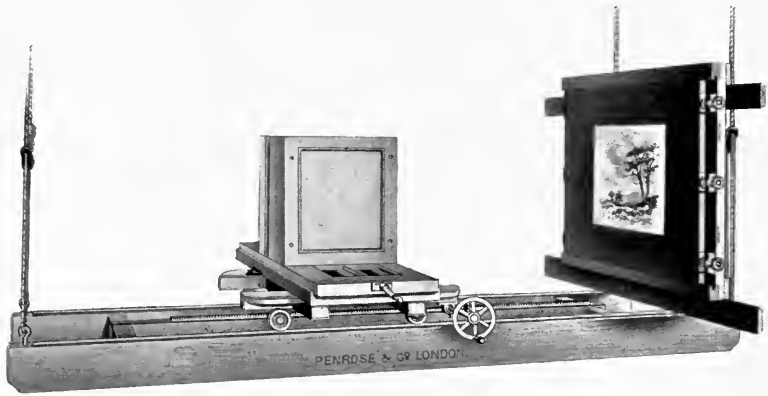

FIG. 21.

thinks, is not a good arrangement, as it is difficult to keep the camera steady while focussing, and also it is not easy to preserve the balance, though this is sometimes adjusted with a sliding weight. The only practical advantage that has been claimed for this form of swing is the possibility of twisting it round to suit the changing direction of the sunlight. But in such a case a very large studio would be required if the swing were any considerable length.

A better idea is to have the beam suspended by two hooks, which secure equilibrium in the longitudinal direction, and the balance can be easily preserved

in the transverse direction. There is certainly a gain in using less than four hooks, as it is found that if one rope is more in tension than the others a strain is set up which causes vibration. Three hooks are better than two or four, as they follow the principle of the tripod in finding a level and preserving equilibrium. Springs inserted between the ropes and hooks

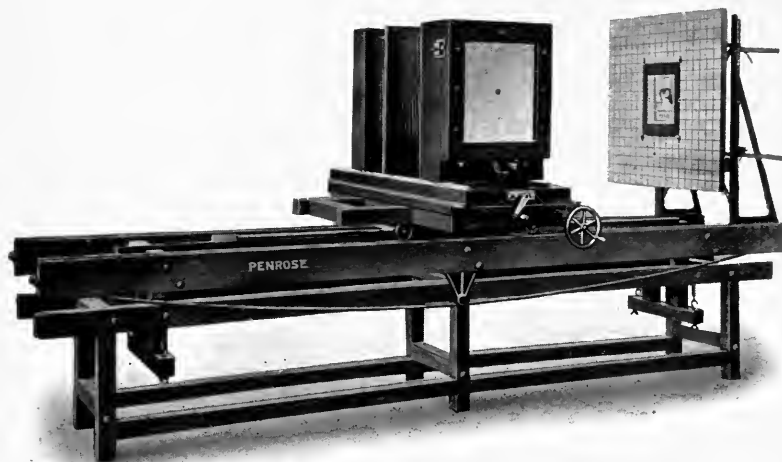

FIG. 22.

are good for absorbing any chance vibrations, and also neutralising the effect of the ropes becoming hard and inelastic by constant tension.

The author considers a spring cradle stand preferable to the rope swing, being a perfect means of absorbing vibration, and having, so to speak, a clear deck when the camera is being worked near the end. The ropes are often found in the way in such case, and take off some of the effective length. It is much more easy to move the camera and perform the focus-

sing operations on a spring stand. Another advantage is that it can be placed anywhere in the studio and easily moved again if required (fig. 22).

In the construction of such a swing base, or the cradle of a spring stand, there are one or two points to be considered. In the first place, it should be of stout timber, at least 6in. \times 3in. for swings up to 10ft. or 12ft., and 9in. \times 3in. for swings up to 15ft. or 16ft.; for swings up to 18ft. or 20ft., 11in. \times 3in. should be used. Unless some such proportions are adopted, the swing will probably sag in the middle or twist in some direction, although Penrose and Co. have overcome this by placing iron truss rods underneath the swing. The timber should be carefully selected of well-seasoned yellow pine.

The width of the swing need not be more than equal to half the length of the camera base, and the length should be worked out according to the focus of the lens to be used, to enable reductions to be made at least a quarter the size of the original. The table has been already given, showing distance of original to ground-glass when copying to different scales, and will show the length of swing required.

The camera may simply slide on the rails, parallelism being attained by guiding battens fixed under its base; or it can be supported on a carriage travelling freely on friction runners, such as are put in window sashes, or, better still, iron rails with grooved wheels can be provided. It is also an advantage to have a rack and pinion motion to move the carriage along the base. The top of the carriage should have stops at each corner,

with an opening between them equal to the width of the camera bed, so that the camera may be lifted off and placed at right angles to its former position, as is requisite in making reversed negatives. A more convenient arrangement is to have a turntable.

THE COPYING-BOARD.

The copying-board is fixed on a sort of easel standing on the rails of the base frame. Whether the easel should be fixed at the end or slide towards the camera is a matter of choice. Sometimes a better light can be thrown on the board if it can be shifted forward, when copying at close quarters, and, moreover, it is then not necessary to bring the camera forward into the full glare of the studio light.

In working with electric light I think it is best to have a fixed copying easel, as the light can be kept more uniform. The copying-board must run in grooves, so as to be capable of being shifted sideways. It should be possible to project it out beyond the base frame,



FIG. 23.

because when copying with the mirror box or prism in position the latter is not central to the base frame, and the copying board must be pushed forward to strike a centre to the lens. The copying-board should

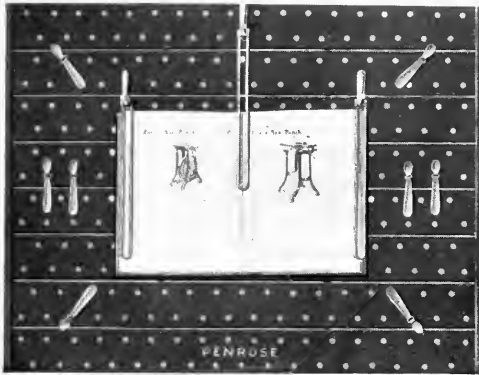

FIG. 23a.

be of soft wood, so that it is easy to stick pins into it. A good plan is to cover the board with a thin layer of cork, or with cork linoleum, in which the pins can be inserted without any trouble, and

there is no unevenness as when the board becomes full of holes. The copyboard will stand changes of temperature better if it is battened like an engineer's drawing-board, not clamped.

A very practical way of overcoming the difficulties due to shrinkage and warping is to make up the board with narrow planks, not more than 6in. wide, each with separate battens, and not tongued and grooved together. In this way each board shrinks or swells separately, and a clamping screw arrangement can be provided at the side for the purpose of squeezing the boards together when the joined edges open.

Recently there has been introduced a copyboard with spring clips working in grooves, which does away with pins, and is a great convenience (fig. 23). Another idea of a similar kind is the Perkins copyboard (fig. 23a).

The size of the board should be at least four times the area of the largest plate the camera will take ; in

other words, its diagonal should be twice the diagonal of a 15×12 plate if the camera is for that size. As a rule the boards in use are fully four times the diagonal of the plate size.

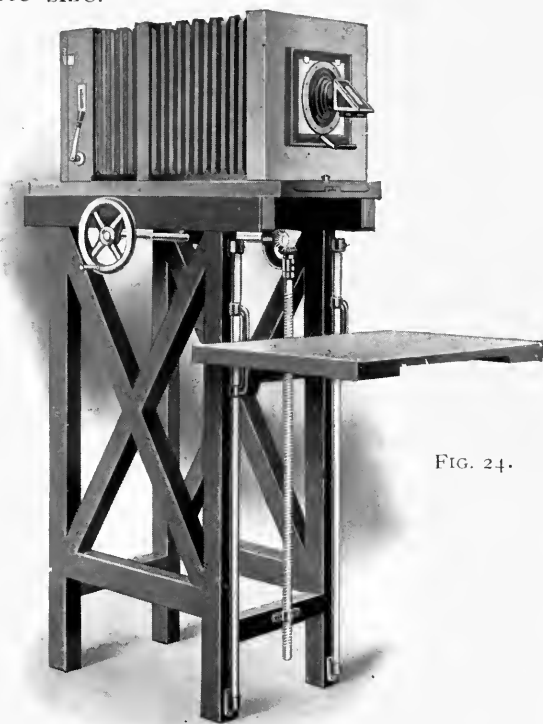

FIG. 24.

A rising and falling movement for the copyboard is not necessary when the camera has a rising front, as is the case with all modern cameras. A horizontal line coincident with the centre of the lens should be struck across the board, and the copy pinned centrally on this line. The copyboard should be painted dead black, as it then gives no reflected light, and is not so confusing to the eye when focussing.

VERTICAL STANDS.

A form of stand which has some advantages is shown in fig. 24. It can only be used when the lens is fitted with mirror or prism, and the lens must be of comparatively short focus, or the stand will have to be so tall as to be inconvenient. Such a stand takes up little room, and the downward illumination of the copy is very perfect, copying being done very well against an ordinary window.

It is very useful in copying from open books, or for making negatives direct from such objects as coins, medals, jewellery, etc. The direct vertical light obviates all trouble due to grain or surface reflections, and shadows may be avoided by having a glass plate for supporting such objects as jewellery, a white reflector being placed at some distance underneath at a suitable angle.

LENSES.

Next, we must decide on the lens, and the essential points to remember are that it must be of the rapid rectilinear type, achromatic, of good covering power at a large aperture, and of fairly long focus. Single landscape lenses, portrait lenses, hand camera lenses, and wide angle lenses must be set aside as unsuitable. It will not be found practicable to use any lens under 9in. focus for the reasons subsequently explained, and even with that length it should not be used for anything larger than half-plate, $6\frac{1}{2}$ in. \times $4\frac{3}{4}$ in.

It was formerly considered that extreme sharpness of definition was less important in a lens for the half-tone process than in one used for line reproduction,

but whilst this may be true to the extent that want of sharpness does not show its effects so readily in half-tone as in line work, it will, nevertheless, be found that a lens that will give perfect definition will be a good one in all other respects. There will be times when its powers will be tested to the utmost in covering a full size plate with fine detail sharply to the corners, and it is then that the operator appreciates the disadvantage of a poor lens.

Before proceeding to consider the various types of lenses on the market, it will be well to explain the reason why lenses for half-tone should be of long focus. It arises from the now well established rule that the distance of the screen from the sensitive plate is directly proportional to the focus of the lens if the diaphragm aperture remains constant ; that is to say, the longer the focus the greater the screen distance. Therefore, if we diminish the focus more and more, we should get to a point where we could not operate the screen at all, for the simple reason that we could not have any space for the corner plates or wires which hold it in position, and to work it at all it would have to be in absolute contact. This would be an impossible condition in the case of wet plate work.

It is true that we may decrease the size of the diaphragm to enable greater screen distance to be worked, but this means increase of exposure ; therefore, we are driven to the practical conclusion that to avoid the necessity of working the screen too close to the plate it is best to use lenses of fairly long focus.

It also follows that a long focus lens will have a narrow angle, so that the rays strike through the screen not far from perpendicular to its surface. A short focus lens of wide angle sends the marginal rays through the screen at a considerable angle from the axis of the lens, so that they have a longer path of glass to travel through, and are refracted more than the central rays, besides passing through the opening obliquely and tending to form blurred oval-shaped dots. Short focus lenses used at a wide angle also give rise to a lot of reflections from the sides of the camera, which are apt to cause foggy plates. Still another reason is that wide angle lenses do not work well with prisms, as they pick up reflections and secondary images from the surfaces of the prism.

Of late years numerous lens makers have brought out lenses specially designed for process reproduction, and the most notable of these is the Cooke Process lens (fig. 25), which has experienced a wonderful degree of popularity. Its peculiar advantage is its great flatness of field, covering the plate to the extreme



FIG. 25.

edges with remarkable definition, even at full aperture. It is a rapid lens working up to $f/8$ for the smaller sizes and $f/16$ for the larger ones, and of moderately long focus— $18\frac{1}{2}$ in. for 15×12 plate. Further, it is well corrected for astigmatism and achromatism, and its elements are simple, there being three separate

lenses, with no cemented combinations. Another advantage is that the system of interchangeable screw fittings introduced by its makers renders it readily adaptable for fitting prisms, colour cells, etc., and for changing lenses from one camera to another, or from a smaller to a larger size. The price is also reasonable compared with some other modern types of lenses. This lens requires more care to ensure parallelism of copy, camera front, and sensitive plate, and also somewhat more care in focussing than lenses with more rounded field. It should not be focussed for the centre of the plate, but at points midway between the centre and margin, so as to secure a general sharpness all over.

Ross's Homocentric has replaced the rapid symmetrical lenses, which for a long time enjoyed great popularity, and which are to be found, even yet, doing good work in many studios. Dallmeyer's rapid rectilinear lens was formerly very popular for copying, and is still used, but this maker has recently introduced a special lens for process work.

On the Continent, Steinheil's Rapid Aplanat, Series VI., was formerly greatly preferred, but it has now been entirely superseded by the Orthostigmat, Series II., introduced by the same firm, and which is an excellent lens, but slower than others for wet plate work.

Voigtlander's Collinear is also a very good lens for half-tone work, Series III. being the best to use. More recently the same firm has brought out the Apochromatic Collinear lens, with the special object of fulfilling the requirements of half-tone and three-colour work, and this lens has been very favourably reported upon.

The Goerz lenses are also admirably suited for process work, and of the two types the writer prefers Series IV., on account of its longer focus.

Of the Zeiss lenses several types are suitable. First and foremost is the Planar, which is in many respects a marvellous lens, on account of its high correction and wonderful covering power at large apertures, but its price places it almost beyond the reach of all but the wealthiest firms. The Protar (Series V.) is a good series of lenses for all practical purposes, and quite reasonable in price. They do not work at a larger aperture than 1:18 (corresponding to about $f/16$ according to the English standard), but they have very fine covering power, and the focus is long enough. They are well corrected for colour work. The Tessar is also very suitable for half-tone. The Apochromatic Tessar is, after the Planar, the best lens for colour work.

Apart from these well-known makes of lenses, it may be said that any good rapid rectilinear lens will serve if it fulfils the condition as to length of focus.

One condition should be insisted upon, whatever lens is chosen, viz., that it must have a slot for taking the Waterhouse shape of diaphragm, because, as we shall presently show, it is necessary to insert irregular forms of stops, and to change them sometimes during exposure. This could not be conveniently done if the lens had only an iris diaphragm. In such case it will be best to have a new tube made for the lens, or, if practicable, a slot in addition, and in front of the iris diaphragm. The Cooke Process lens has this

feature in all cases, and the Zeiss lenses are thus provided if specially ordered. This is very convenient, as both systems may be used.

DIAPHRAGMS.

Lens makers who cater specially for the requirements of process workers supply, when required, sets of diaphragms with suitably shaped apertures other than round ones. The use of these stops will be explained in a later chapter, and it will be sufficient to say here that a set of square apertures, at least, graduated in size, is a great convenience and an aid to uniformity of work. The Penrose Diaphragm System (fig. 26), which is supplied with all Cooke Process lenses, and can be fitted to any other lenses, consists of a

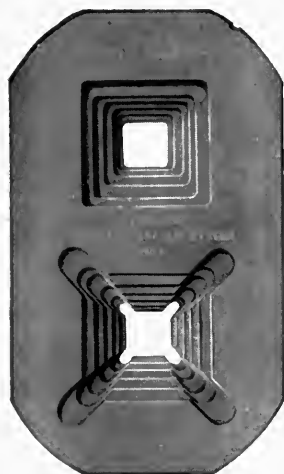

FIG. 26.

set of stops with square apertures, or square apertures with extended corners to promote joining up of the dots. The apertures are graduated on a definite system, having an exposure ratio to each other of $1 : 1\frac{1}{2}$, *i.e.*, if a given aperture requires an exposure of one minute, the next size smaller requires one and a half minutes. A book of tables supplied with them shows the screen distances for a given size

of stop and screen, at any particular extension of the camera.

Another form of stop with ingenious features is Smith's patent adjustable diaphragm (fig. 27). It has

two sliding leaves, which can be moved nearer together or farther apart to form an aperture of any desired size. A scale on the side indicates the setting for the sizes of apertures used in the Penrose diaphragm system. The central part of the stop is also made to rotate, so that the aperture can be inclined at any angle to correspond with the ruling of the screen.

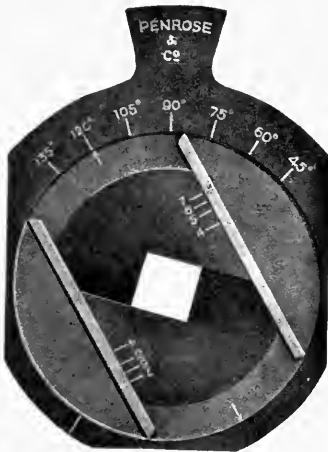

FIG. 27.



FIG. 28.

For colour work, stops with corners extended in one direction diagonally are often used, as fig. 28. Such stops give a single line effect from a cross-line screen, and are believed to help the gradation, but this is not actually the case. The results are, however, smoother, especially from rough surfaced originals, and the formation of objectionable pattern markings is minimised.

MIRRORS AND PRISMS.

Any camera for making negatives for process work should be fitted with a mirror box or prism.



FIG. 29

The mirror plate fits in a triangular box (fig. 29), having one side set at an angle of 45° to the front of the camera. The lens is fixed on the side of the box, which is at right angles to

the front, so that when the camera is placed sideways to the object, the lens pointing towards the latter, the image is transmitted through the lens, reversed, as all lens images are, but the mirror catches the reversed picture and reflects it to the sensitive plate the correct way, *i.e.*, the same as we would look at the original. When the resulting negative is laid film down in contact with a zinc plate, the image is again transferred reversed, but when the printer subsequently lays a piece of paper on the inked plate, and takes off an impression, the picture comes the right way again. I make this simple explanation, because it is often very difficult to make people understand the necessity for a reversed negative, though if they ever attempt to make a print directly on metal from an unreversed negative of some lettering, they will be taught completely the necessity for it.

On the relative advantages of mirror or prism, I may point out that it largely resolves itself into a question of first cost. A prism for 15×12 lens will cost from £8 to £16, according to the diameter of the lens and the reputation of the firm from which it is bought, this price including the fitting in a brass

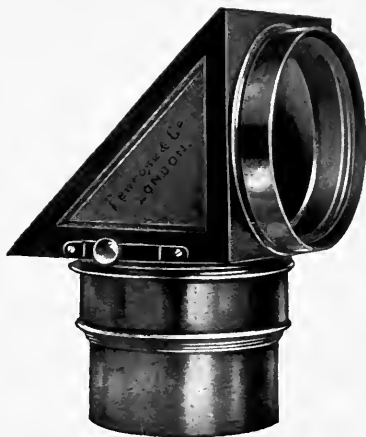

FIG. 30.

or aluminium box, which is usually screwed on to the front of the lens, as shown in fig. 30, and applied to the camera as shown in the diagram fig. 31; *ab* is the sensitive plate, *cd* the copyboard. Some workers, however, prefer the prism attached to the camera front behind the lens.

Scientifically speaking, the hypotenuse of a right-angle prism is a perfect reflecting surface, for a portion of the field; this bright portion is bounded by a coloured fringe, beyond which the field is very dark. As this dark region comes within 6° of the centre of the image on one side, it is impracticable to take advantage of this total reflection, so that all prisms are silvered, and then act as a protected mirror. Suffice it to say that all prisms in practical use are silvered, and once silvered they rarely need doing again. Thus the great advantage that can be claimed for the prism is that it is a permanent reflector, whilst the

mirror is very susceptible

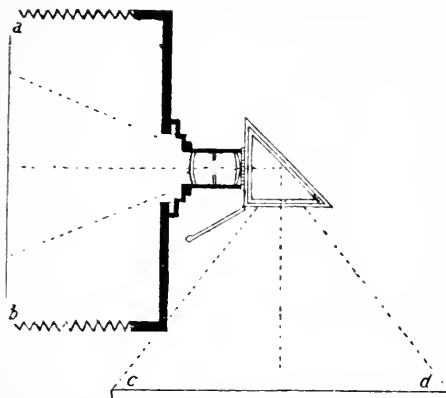

FIG. 31. Illustrating position of prism in plan—
a b sensitive plate, c d copying-board.

to tarnish, and constantly needs silvering, which is usually too delicate an operation to be done at home. It is contended that a prism is slower than a mirror, because there is a loss of light by absorption in the thickness of the glass and by reflection at its surfaces, but when

it is remembered that a mirror can never be maintained in sufficiently good condition to make this comparison possible, such a contention can have little weight. The prism is especially convenient in the colonies or elsewhere abroad where the means of getting mirrors resilvered are not ready to hand. At its best the mirror is undoubtedly faster than the prism for black and white work with enclosed arcs.

An optical plane mirror costs about one shilling per square inch. This article is a piece of the finest plate glass, about $\frac{3}{16}$ in. thick, ground down on one side until it is optically flat. It is then silvered on the surface—*i.e.*, the side which has been optically worked—not on the back of the plate, as in the case of an ordinary household mirror. The reason of this is obvious, for if you try to photograph a reflection in an ordinary mirror a double image will result, one reflected from the surface of the glass, and the other from the silvering at the back.

An optical mirror must be very carefully used or it will soon become tarnished and scratched, and must then be resilvered ; this resilvering, which costs about one-fourth the price of the mirror, will form a serious item of expense, if it has to be done often, and will involve stoppage of work for two or three days, unless one has another mirror to go on with. But if due care is exercised a mirror surface should last a long time. Metallic mirrors have recently been introduced which require no silvering, but it is said they do not reflect quite such a bright image as the best glass mirrors in perfect condition, and if scratched it is very costly to renew the surface.

The mirror should be carefully put away when not in use, in a case which is air, dust, and damp proof. If the surface becomes a little tarnished, get some finest jeweller's rouge, well dried by spreading it out on a sheet of paper on the top of a stove, and well rubbed to powder. Now take a tuft of cotton, also warmed to dryness, and rub it in the rouge, then upon a sheet of clean glass, so as to smooth down any grittiness of the powder, finally applying it to the mirror with a gentle circular motion, and patiently rub until the tarnish is worn off.

Mirrors are usually made from 4in. \times 3in. up to 8in. \times 5in., and 7in. \times 4in. is an average size which will suit any lens up to 3in. diameter. The rule is that they should be about one inch larger than the diameter of the lens one way, and also about one inch more than twice the diameter the other way. Two should be purchased, so that one may be in use whilst the other is being silvered.

Focussing Glasses and Other Accessories.



FIG. 32.

A focussing eyepiece of moderate power for the ordinary focussing of the image is required, and also a high power one which will enable the screen effect to be seen readily (fig. 32). Penrose and Co. make a little microscope for the latter purpose called "The Midget" (fig. 33). On the Continent there are several of these small microscopes on the market, notably those by Steinheil and Zeiss. These high powers are quite objectionable for ordinary focussing, as they magnify the image of the texture of the original and the grain of the ground-glass to such an extent as to mislead the operator.

The remaining requirements are a large focussing cloth of soft, opaque black material, and a rule for measuring the size of image. Transparent celluloid rules are good for this purpose, as the image can be seen through them. A box of drawing pins should also be provided for fixing the copy on the board. These should have a large head, and be capable of being easily pulled out. Steel pins with the head and point in one piece are very popular.

Unmounted prints, cuttings from books and newspapers, and



FIG. 33.

pieces of fabric are best placed in a light box-pattern printing frame with plate-glass front, which is hung in front of the copy-board. This keeps the copies flat, and the photographing through glass is no detriment, provided the lighting is arranged so that there are no surface reflections. A good arrangement for the purpose is the "Eclipse" copyholder,

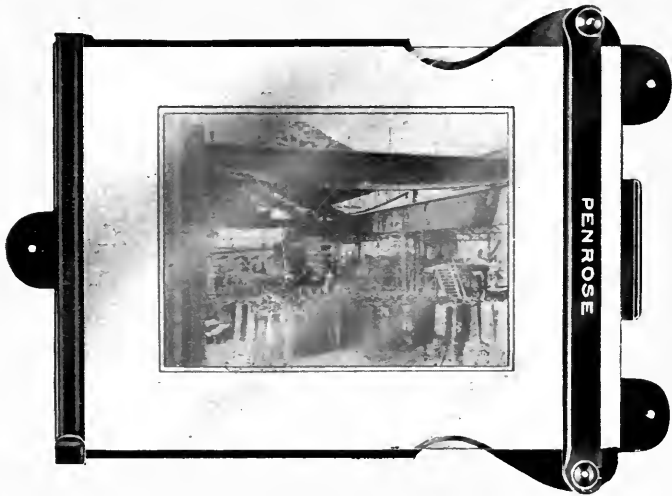

FIG. 33a.

made by Penrose and Co., consisting of a metal frame with glass front held down by springs and readily removable (fig. 33a). With the clip copyboard previously described, a sheet of glass can be clipped on to the copyboard.

The only other articles needed for the equipment of the studio are the ruled screens, which are described in Chapter II., and the arc lamps, which will be described in a later chapter.

CHAPTER IV.

THE DARK ROOM.

MUCH of the success of half-tone work depends on having a properly appointed dark room. It will not do to set apart some stuffy little cupboard-like room for the purpose, nor is it advisable that it should be in a room separated from the studio by any distance. A comparatively large and well-ventilated room, with its entrance situated preferably at that point of the studio nearest to the back of the camera, is required. About half the floor space allotted to the camera will be a good size. Thus, for working 15×12 plates, 9ft. to 10ft. \times 6ft. will be the dimensions, and this makes a very comfortable dark room, but if it is possible to get a room 10ft. \times 10ft. so much the better. The sink and bench at right angles to it for filling the dark slide will take away about 3ft. in either direction, so that this leaves the room none too large.

Instead of a door, some operators prefer a curtain, but it is apt to harbour dust unless shaken into the open air frequently. A sliding door is a better arrangement than a hinged door; and, better still, a lobby, with inner and outer door, so that one may be shut before the other is opened.

The best arrangement of all is, perhaps, no door at all, but a light trapped passage, as shown in diagram fig.

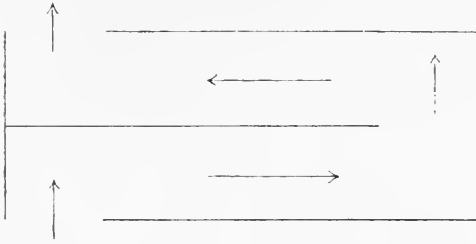

FIG. 33b.

33b. Where several dark rooms adjoin, a long passage could connect the whole, and so ensure the entrance to each room being in the shade.

We give an illustration of an actual dark room in an important London process studio (fig. 34).

The ventilation of the dark room is a more important matter than most people appear to think. Not only does a perfectly ventilated dark room add to the

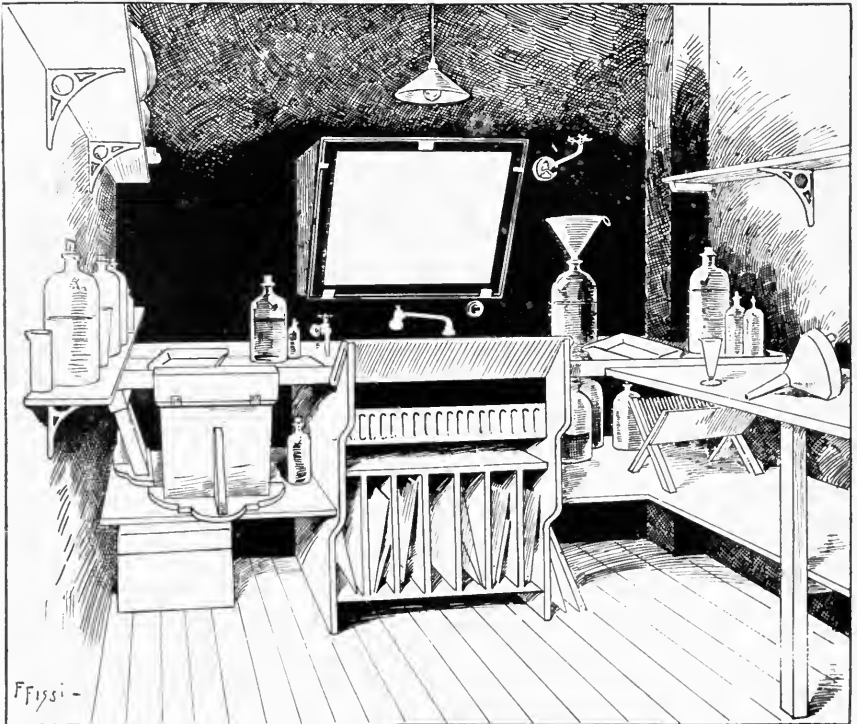

FIG. 34.

comfort of the operator, but it also contributes in a large measure to the success of the delicate processes worked therein. Work done in a properly-ventilated room maintained at an even temperature will be much more uniform than it would be otherwise.

Ventilators of the form shown in fig. 35 can be purchased ready made in sheet iron with any desired length of piping, and furnish a cheap means of ventilating a dark room.

An electric fan is a luxury, but, nevertheless, an excellent thing for keeping the dark room cool. It will, however, raise dust unless the air is filtered before reaching the fan.

It must be borne in mind that wherever there is a ventilating outlet there must be at some other point an inlet for fresh air, and the most convenient way of arranging this is to provide it in the lower part of the door by having a few holes bored through, and an inner panel arranged so as to cover up the light coming through them without obstructing the passage of air.

A louvre ventilator—which is something like a Venetian blind—over the top of the door or window (if there is one) is a good arrangement for ventilation, where the cowl-shaped ventilator cannot be used.

A few holes or slots cut in the partition near the ceiling, and covered with some skirting to cut off any



FIG. 35.

stray light, is a rough-and-ready means of ventilating, which is used more often than not.

The walls and ceiling or woodwork should be black, or of some dark shade which will not reflect stray light.

Another matter to which attention must be paid in building a dark room is in regard to the prevention of dust, which occasions great difficulty in some processes. An effective way of minimising it is to cover all ventilating apertures with something like cheese-cloth or book muslin or gauze, in double thickness. Also the walls and ceiling should be covered with varnished or painted matchboarding, or papered with a smooth glazed or varnished paper, and the benches covered with lead or zinc, so that they may be sponged down occasionally. The floor should be laid with linoleum, which should be washed at least once a week and damped and swept daily.

At times when dust is very troublesome the air may be sprayed with a scent spray bottle filled with clean water before commencing work.

It is very important to maintain an even temperature in the dark room, and it will contribute greatly towards uniformity of work if the temperature can be maintained at about 60° F. all the year round.

In the winter time some way of warming the dark room is requisite, and, of course, there must be no illumination from the source of heat. It is undesirable in any case that there should be a naked flame in the dark room, especially near the floor, as inflammable vapours, like ether and benzole, have a way of "creeping" along the floor and becoming ignited at a stove or fireplace.

It is possible to obtain enclosed gas stoves and gas radiators specially suitable for photographers' dark rooms, and there are also numerous excellent little oil stoves on the market which are as good as anything for the purpose. A hot water pipe or a stove pipe passing through the room will often serve, but will have the disadvantage of not being controllable.

Perhaps the ideal form of heating arrangement for the dark room is an electric radiator, which may be in the form of a hot plate, so that it can be used to warm up dishes or solutions. A good substitute for an electric radiator, which will cost nothing to run, and which may be readily installed, is the arc lamp resistance*, which could be placed in the dark room and serve a double purpose, a good deal of heat being given off by some resistances. They would, however, have to be removed in the summer time.

DRYING CUPBOARD.

A drying cupboard is also an arrangement which will serve the two purposes of drying negatives and keeping the room warm. An oil stove, or a very small gas jet in a metal tube, will furnish the heat required.

Fig. 36 shows a suitable form of drying cupboard with wooden body, but having a sheet-iron bottom in the form of an inverted shallow box, with holes punched all round, so as to allow sufficient air to mix with the gas to prevent the stove burner being "choked." The heat accumulates in this inverted box, and the bottom of the cupboard is thus warmed very evenly. It will be even better if an electric radiator can be

* An electric hot plate which serves also as an arc lamp resistance has been recently introduced.

placed inside. The wooden sides of the box near the bottom are perforated with holes, through which the cold air is drawn and rises with the heated air in the



FIG. 36.

box until it reaches the top and passes out of the ventilator. An ordinary plate rack can stand in the box to hold the negatives.

An ordinary cupboard for keeping light sensitive solutions, dry plates, or sundries in is also a very useful accessory, and tends to keep the room tidy.

THE SINK.

The sink is the most important fixture in the dark room, and it is well worth going to some trouble and expense to get a really good arrangement in this way.

The author does not believe in lead-lined sinks unless made of very thick lead, and having burnt—not soldered—joints, which makes them expensive.

Some think that a well jointed teak or pitchpine sink is the best thing, and if kept wet by continuous use it is not likely to leak. A coating of "Mogul" varnish will make it safe. Slate sinks are also very good.

The cheapest sink is one of earthenware, and it is safe from the point of view of leakage; but a drawback is that it leads to too many breakages unless

a wooden grid is placed at the bottom. Get the deepest, which will be $4\frac{1}{2}$ in. inside. A very good size is the 36 in. \times 22 in., which is a stock article. Larger sizes may have to be made to order.

This sink should be supported on brick piers or heavy iron brackets, though in many cases a wooden stand is made to serve the purpose, and, if possible, the waste pipe should be constructed of enamelled stoneware tubes, which can be had with a stoneware trap and any kind of bend and connections. These are very reasonable in price, and if the joints are caulked and pitched a waste pipe will be obtained which will stand anything, and last practically for ever. On the other hand, a lead pipe will be a constant source of trouble owing to being eaten away by the chemicals put down. The acetic acid used in wet plate development is a very vigorous lead destroyer.

The water supply of the dark room is a very important consideration. Even when there is a supposed continuous supply from the mains it is better to have a large cistern overhead, as a failure of the water supply would mean total cessation of work.

Around the sink should be built slate draining slabs, or wooden boards. These may be on a higher level, and the sink joined up to them with a skirting resting on the top of it. If wood is used, a sheet of lead laid over the whole, with an opening the size of the sink, and beaten to fit over the inside sides of the latter, gives the equivalent of a deeper sink and prevents splashing. The draining boards should slope

slightly towards the sink, and the latter, with its draining boards, should occupy the whole of one of the longest sides of the room.



FIG. 37.

A good swinging arm spray tap should be fixed, the form of this piece of apparatus being such that the act of bringing it into position over the centre



FIG. 38.

of the sink starts the flow of water (fig. 37). It is a convenience to have also an ordinary tap for filling bottles, etc. This tap should be high enough up to get a Winchester bottle, with funnel, under it. The spray should likewise be high enough up to get a negative or dish easily under it, without chance of bringing the film into contact with it, yet not so high

up as to splash all over the place. A rubber collar or a piece of rubber sheeting wired round the spray nozzle will lead the water down to the negative, and be some safeguard against undue splashing.

A little wooden stool should be provided to rest plates or dishes on whilst developing or washing. A wooden grid in the bottom of the sink saves many breakages of glassware.

Underneath the sink may be a rack for dishes. The soaking trough for old negatives and glass polishing bench is best arranged for outside the dark room. This soaking trough is best made of oak and lead lined (fig. 38). The joints must be "burnt," not soldered.

THE DARK ROOM ILLUMINATION.

The illumination of the dark room is an important matter. A window for daylight illumination is not a very desirable arrangement even for day work, because if it is made "safe" enough for working when strong sunshine is upon it, there will not be light enough in dull weather. The reverse case would be equally a source of trouble. Even though it were possible to make the light safe for all times it must be remembered that the daylight is varying from hour to hour, and as the operator must judge his negatives by looking through them towards the source of light, it would never be possible to secure any sufficient uniformity of work.

There is no objection to having a window which is made "safe" for all degrees of illumination for the general lighting of the room, so as to avoid burning gas or electric light all day long, and giving just sufficient light to avoid having to grope about to find things, but we must also have at the back, or at one side of the sink, a lantern for development and examination of negatives. This must be capable of furnishing both white and non-actinic light, which can

be secured by having two or more fronts to it. One may be white opal or ground-glass and the other of amber or ruby glass, or glass coated with stained gelatine, according to whether we are working wet or dry plates. Perhaps the best arrangement for all purposes is to have the lantern with a permanent front of white glass and two folding or sliding fronts containing amber and ruby, which can be used alternatively or together. If used for electric light this lantern may be constructed of wood, but for gas it must be of sheet metal and very large, with plenty of ventilation, or it will get hot and the glass fronts will be continually breaking. The same thing applies,

though in a less degree, to oil lamps.

The position of the lantern should be at the back of the sink, either directly opposite, or at the side. In the latter case it should be placed diagonally across the corner. The front should slope over towards the sink, or the light should be reflected down by means of a hood (fig. 39).

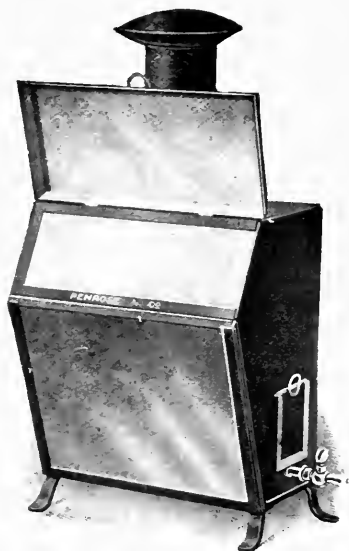

FIG. 39.

Instead of using coloured glass, which is frequently unsafe, it is preferable to use the non-actinic fabric sold for the purpose of covering dark

room windows, and to enclose it between two sheets of plain glass. This gives a more diffused illumination, which is pleasant to work by.

We must caution the inexperienced worker against being tempted to buy the so-called non-actinic electric incandescent lamps. They are certainly coloured ruby, but are as a rule quite unsafe. It seems to be an



FIG. 40.

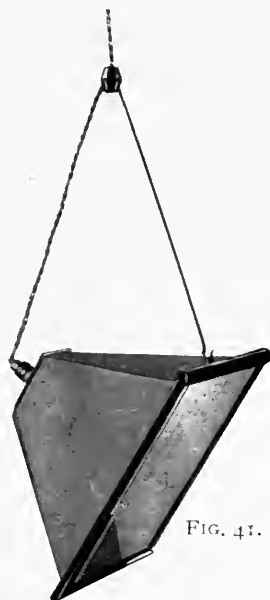

FIG. 41.

impossibility to make a safe electric lamp, probably owing to the fact that the glass blower could never get the walls of the bulb the same thickness. The electric light being also rich in actinic rays is more penetrative through the coloured medium than is, say, gas or oil light.

A very effective compromise for the coloured glow lamp is that illustrated in fig. 40. The large bulb encloses an ordinary lamp, and, being split, the lower

half is hinged so that it can be let down, and give white light at will. The coloured glass of the outer bulb is thick and dense, and a certificate of its safety is given by the manufacturers. The lamps are supplied in amber and ruby. For three-colour negative making, where it is very important to be able to have the illumination of such a colour as the plates will be insensitive to, it is desirable to have a separate small lantern of the kind



•FIG. 41a.

shown in fig. 41, so that, if necessary, different screening glasses can be put in. Special fronts can be made up by coating glass with coloured collodion. What is called a "safe light" for three-colour work is made up of two, and sometimes three, glasses or films, and forms a very dense ruby shade. The exact colours and final combinations have to be determined by spectroscopic tests.

A lantern for indirect lighting (fig. 41a)—the light being at the top, so that only reflected light comes through the safe light—is found to be very good for colour work.

BENCHES.

A narrow bench down each side of the room is necessary, one side being kept clear for filling the dark slide, which should lean against the wall of the room

when being filled. To avoid the dark slide slipping off the bench through being inclined at too great an angle, it is desirable to fasten a fillet of wood on the bench to stop the slide. A place should be reserved, also alongside, for the lid of the slide, which, if put down on the floor underneath, is apt to get kicked, owing to the darkness, and thereby split or broken.

A drawer or two under the bench to contain dusters, polishing cloths and leathers, cotton wool, filter papers, and other things which should be kept dry and clean, is a convenience.

THE SILVER BATH.

The position of the bath when the wet plate process is used should be as near as possible to the dark slide, and as far as possible from the developing sink, so as to obviate splashes of developing or other solutions finding their way into it. The position should be such, however, that a good light falls upon it, so that one can easily see to put the plate in and take it out. If a dipping bath is used, the mouth of it should be level, or thereabouts, with the bench.

Better still is the plan of having a box for the bath as here illustrated (fig. 42). Such a box can be constructed of matchboarding, and should be about 6ft. high. In constructing a dark room, it would, of course, be built into it, a recess probably suiting well for the



FIG. 42.

purpose. The depth will be about 12in., whilst the width will be suited to the size of bath that is being used. For a 15 × 12 bath, 18in. would be a good width. About three feet from the floor is an opening the full width of the box and the same measurement in height, so as to leave a square opening. A sliding door to run up and down like a window sash, and balanced with a weight, should be fitted to run in deep grooves that effectually shut out the light when the door is closed. At a convenient height from the floor is a shelf on which the bath rests, with its bottom edge pushed against the front of the box, and its back resting against a rail about five inches away from the back of the box. An improvement would be to have a dish or tray the size of the bottom of the shelf, which would catch all stray drainings when removing the plate. The dipper is provided with a hole in it near the top, so that it can be hung up on a nail, whilst its lower end remains just inside the mouth of the bath. In this way the dipper can be hung up with the plate left on it to drain, whilst the operator is performing other operations; or an assistant can always have a plate ready for the next exposure. If there is any difficulty in lighting the interior of the box, it can have a coloured window in the side or in the top, if it does not extend to the full height of the room, supplied with an incandescent lamp to illuminate it. The lamp previously illustrated (fig. 40 *ante*) could be hung inside from the top of the box, and would suit admirably without any alterations.

In the winter time a spirit lamp may be placed on the shelf beside the holder in order to keep the box

at a uniform temperature, whilst in excessively hot weather a dish of ice will keep all cool.

FUME CHAMBER.

The blackening of negatives with sulphide must not be done in the dark room, as the fumes are liable to upset the working of the bath. The best plan is to have a separate room, but if this cannot be secured, a good arrangement is a sink fitted up outside a window, enclosed with glass, something like the window cases for ferns and plants, but with some opening or perforations to allow the fumes to escape freely into the open air. If this cannot be arranged, a fume chamber, such as may be seen in any chemical laboratory, should be erected.

In case any reader may never have seen such a thing, it may be understood as very similar to the bath box just described; in fact, the same pattern would do with a little modification. The sliding sash has usually a glass pane in it. The shelf is on a level with the bottom of the opening, and is lead covered. It is all the better for our purpose if there is a small sink with water supply and waste pipe in the box. At the top there must be a ventilator leading to the open air, or into a chimney, and a small gas jet should be burned high up in order to cause an upward draught. Of course, all joints and crevices must be carefully stopped up.

DIPPING BATH.

The dark room outfit is comparatively simple. If the wet collodion process be worked, as it undoubtedly will be for commercial work, a dipping bath (fig. 43)

will be required, and the only point to pay attention to in selecting this is to avoid porcelain baths or heavy green glass baths. Also the author does not recommend ebonite or guttapercha dipping baths, as they are so difficult to clean out. The best thing is a white glass bath with parallel sides. They are perfectly



FIG. 43.



FIG. 43a.

transparent, and thus it can be readily seen when the bath is clean. A well-made wooden case, with lid, should be provided for the bath, as also illustrated in fig. 43a.

DIPPERS.

For a dipper to support the plate when immersing it in the bath, a white glass one (fig. 44) is the most



FIG. 44.



FIG. 45.

reliable, and though it may be liable to breakage, it is very cheap. An ebonite dipper (fig. 45) is not so liable to breakage, although it is rather

brittle, but one can never tell what action it may have on the bath, and it is not easy to determine when it is clean. In America a forked ebonite dipper is used, as shown in fig. 42 *ante*. In case of breakage of a dipper, one may be made of wood soaked in paraffin wax, but it is not advisable to use this for long. A dipper of pure silver is an excellent but rather expensive arrangement.

FLAT BATHS.

Although the author recommends a dipping bath as the best security for keeping the bath solution in good order, he does not ignore the fact that many practical workers are daily using, and prefer, simply a horizontal dish. This may be the ordinary porcelain deep dish,



FIG. 46.



FIG. 47.

or one of the deep glass dishes which are sold for the purpose. Very large trays are of ebonite, guttapercha, papier-maché, or wood, the latter being thickly coated with some protective varnish. A mixture suggested for this purpose consists of bitumen and beeswax. Wooden trays with glass bottoms are sometimes met with, but it is not easy to get them free from leakage.

A style of tray used in the Government Survey Offices is illustrated in fig. 48. It is of ebonite, with an outer casing of teak.

The advantages claimed for the horizontal bath tray are that it requires less solution, and that by exposing a larger surface to evaporation the alcohol and ether which the bath takes up from the plate have a better

chance of escaping. There is, however, more risk of the bath becoming contaminated with foreign matter.

If the horizontal bath is used, it should be provided with a loosely fitting cover in the shape of an inverted box, which rests on the rim of the dish without touching the shelf or bench, as it would in the latter case pick up dirt, which might get into the bath.

For this form of bath, plate lifters of silver wire or ebonite are used (figs. 46 and 47).

The horizontal bath should be provided with a rocker, which may be simply a piece of wood about $1\frac{1}{2}$ in. in height screwed on to the bench. The tray should be three or four inches larger than the plate, so that the solution can all be tipped to one end, allowing the plate to be placed in "high and dry." The solution can then be rocked over the plate in one even wave, and kept in motion, flowing to and fro. If much work is done, a small motor should be arranged to keep the baths continuously rocking. This is actually adopted in one large establishment.

Most of the operations of wet plate development being done by pouring the solution on to the plate whilst held in the hand, dishes are hardly necessary. These are sometimes used for intensification—one for the bleaching solution and one for the blackening when silver is used, but a dish is objectionable with sulphide solution. These dishes may be the size of the largest plate worked, and of the deep kind.

MEASURES AND SCALES.

A set of graduates, comprising 40 oz., 20 oz., 16 oz., 10 oz., 8 oz., 4 oz., 2 oz., 1 oz., and 60 minims is a

necessary part of an outfit. Likewise scales and weights from $\frac{1}{2}$ grain up to 1 lb. Two sets will be required—grain scales weighing from $\frac{1}{2}$ grain up to 2 drams, and pound scales weighing from $\frac{1}{4}$ oz. up to 1 lb.



FIG. 48.

ARGENTOMETERS.

An argentometer (fig. 49) is a necessary part of a wet plate outfit. By its means the number of grains of silver in each ounce of bath solution is determined. As the bath gets weaker by use, it may be tested by this instrument, and fresh silver added

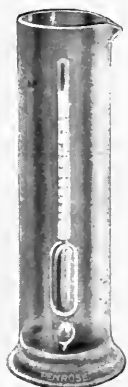

FIG. 49.

to bring it up to strength again. The continental argentometer registers percentage of silver in the solution instead of the number of grains per ounce. Another form of argentometer used on the Continent reads parts or grammes per cubic centimetre.



FIG. 50.

For instance, if ten divisions are indicated at the surface of the solution which is being tested, this implies that 10 grammes of silver are contained in 100 c.c. of solution. When purchasing one of these instruments, it should be ascertained which method of reading is adopted.

PLATEHOLDERS.

A pneumatic plateholder (fig. 50), which attaches itself to the plate by suction, is a useful article. It should be of solid red rubber, as this form is most durable and powerful. For larger plates various contrivances are used for supporting the plate. The simplest, and probably the most effective, is a stone jar with an indiarubber ball in the mouth of it, the ball being chosen too large to be pressed in. The plate can be rested on this and swivelled about in any direction. One of these arrangements can stand in the sink for developing, and another on the bench for collodionising.

STIRRING RODS, ETC.

Several glass stirring rods will be useful. They should be thick, as it is then possible to use them for breaking up crystals. A small glass mortar and pestle is also very good for that purpose. A good porcelain mortar and pestle is in any case essential.

FUNNELS.

A few funnels are wanted. One large glass one, about 10in. diameter, should be kept for the silver bath, and it should not be used for anything else. It is good to have one of every size, and keep each for its special purpose. They run up in size from 2in. to 10in., increasing by 1in. in diameter. For the intensifier it is best to use a papier-maché, ebonite, or guttapercha funnel, as it cannot be mistaken for any other purpose. A funnel stand is a cheap and useful accessory (fig. 51).

COLLODION BOTTLES.

It is always better to let collodion settle rather than filter it, but if for want of time it must be filtered, a funnel with the top edge ground flat, and a glass plate laid on in order to prevent evaporation, is a good arrangement. One, perhaps better, but not having



FIG. 51.

so large a capacity, is the old-fashioned collodion filter bottle (fig. 52). The bulb at the top is stoppered, and in the bottom of it is a neck ground to fit into the bottle. Inside this lower neck of the bulb is stuffed a tuft of cotton, with a tube passing through and descending into the bottom vessel. This lets the air escape as it is driven out by the descending fluid, and helps the



FIG. 52.

filtering. Of course, the tube must always be kept above the level of the liquid in both vessels. Fig. 53 is another form in which the filter and pouring bottle are combined. The inner funnel descends nearly to the bottom, and a piece of muslin is tied over the end. All the liquid poured out must therefore pass through this filtering medium.

For keeping collodion in bulk, a glass bottle with tap near the bottom is the best arrangement. The collodion is then drawn off at all times free from sediment. The next best thing is to fit a syphon to an ordinary bottle.

A collodion pouring bottle (fig. 54) is a decided help towards securing clear negatives. It is sometimes known as a "cometless" collodion bottle, because of the property claimed for it of trapping the floating particles which produce the spots on negatives known as "comets." It is a tall glass bottle, a large cap covering the neck and protecting the pouring lip, so



FIG. 53.

that dust cannot adhere and find its way to the plate.

The inner neck descends about an inch into the bottle, so that when pouring only the liquid on the surface runs out, the sediment from the bottom of the bottle being caught by the projecting neck. There is a notch down the side of this neck, so that any collodion running over finds



FIG. 54.

its way back to the bottle. The tallness of this bottle assists the precipitation of any sediment in the collodion. A tall bottle of conical shape is also good for pouring collodion.

DEVELOPING CUPS.

There are some handy developing cups of glass or ebonite to be had. They nest within one another, and are sold in sets of three, large and small, and being of thick toughened glass they are very durable. These cups are good for pouring the developer on to the plate.

BATH AND OTHER BOTTLES.

A gallon white glass bottle will be required for containing the bath solution when out of its trough for filtering or any other reason. This bottle should not be used for anything else. Being of white glass, it is useful for sunning the bath. It is all the better if provided with a glass tap (fig. 55).



FIG. 55.

Three or four bottles are necessary. One for the developing solution, two for the intensifying solution, and one for general use. Don't keep a lot of unnecessary bottles in the dark room—

they only make the place untidy, and render it more difficult to keep down the dust.

For workers on a small scale a couple of dropping bottles are useful for containing the iodine and the cyanide solution used for "cutting" the negatives, as described later on. The best form of dropping bottles are on the pipette principle.



FIG. 56.

The Autometric dropping bottle (fig. 56) is excellent and cleanly for the purpose. The dropping tube is graduated, and therefore saves measuring. One of these bottles is useful for keeping a stock solution of silver nitrate for strengthening the bath, adding to the redeveloping

solution, or to the silver solution used with the copper bromide intensifier.



FIG. 57.

EVAPORATING BASINS.

For the purpose of boiling down the bath solution, an evaporating basin and gas or spirit stove will be required, besides an iron tripod to support the basin over the stove. The naked flame must not be allowed to come into

contact with the basin, or the latter may be cracked and a valuable lot of solution wasted. It is easy to avoid this by having a tin tray filled with sand, bedding the evaporating basin in this, and applying the heat to this "sand bath."

An excellent arrangement for the purpose, comprising stove, draught-guard, and iron tray for the sand bath is shown in fig. 57.

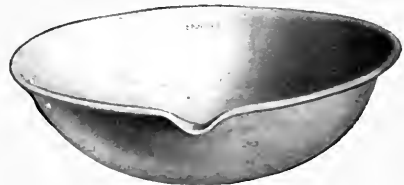

FIG. 58.

The evaporating basins may be either of porcelain (fig. 58) or enamelled iron (fig. 59). There are two kinds of the latter, one being made of stamped steel, and the other of cast iron. The latter is best for large sizes. One is apt to be suspicious of trusting a silver solution in an iron vessel,

even when enamelled, but these basins are certainly in use in many of the largest establishments without any disadvantage being known. The porcelain basins are undoubtedly the most cleanly, and a careful worker will prefer them. To determine when the bath has been boiled down to the right strength, it is a good plan to have a specific gravity bulb. This is graduated to float in a given strength of solution. The bulb is thrown in

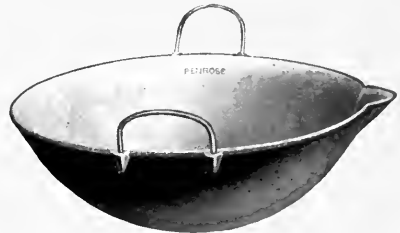

FIG. 59.

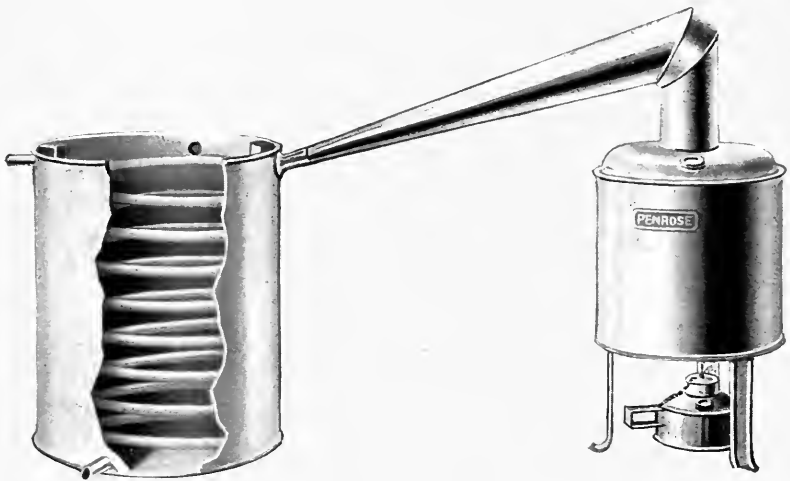

FIG. 60.

when the boiling commences, and when it comes to the surface and remains floating it is known that the operation is completed.

The specific gravity of a freshly-made silver bath of the correct strength, namely, thirty-five grains to

the ounce, will be about 1.069, and when boiled down to half strength it will be 1.116, so that the latter is the figure for which the bulb should be chosen.*

STILL.

In the colonies and in country districts where a supply of distilled water is not easily obtainable, a still will be found a good investment for obtaining a supply of pure water for the bath. There are several very cheap patterns on the market for the purpose, a good form being as fig. 60.

BUNSEN BURNER.

A small laboratory Bunsen burner (fig. 61) is a useful accessory in or near the dark room for rapidly drying off negatives, warming negatives for varnishing, warming solutions, etc.



FIG. 61.

PLATE RACKS.

A couple of plate racks, one for the clean glass and the other for finished negatives, are necessary, and most operators believe there has been nothing better invented than the old-fashioned V-shape folding rack, but it should be of a substantial pattern. The V-shape made fixed (non-folding) is the best idea (fig. 62). For very large plates something more substantial is required, and the rack is generally provided with a heavy base, as fig. 63.

* See page 216 on this subject.

NEGATIVE GLASS.

An outfit of negative glass will be required for wet plate work, and it is seldom worth while working any size below $8\frac{1}{2} \times 6\frac{1}{2}$. Patent plate is undoubtedly the best to use, but it is expensive.

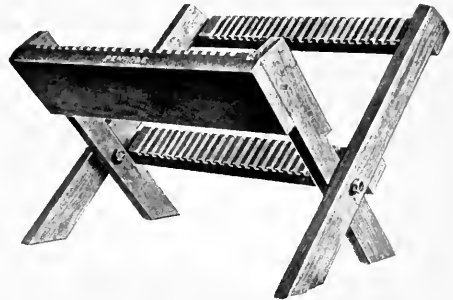

FIG. 62.

If, however, it is carefully handled in the washing and cleaning operations, it will last for a long time. Several cheap imitations of patent plate have been introduced of late, which, whilst not having the same planeness as patent plate, are better than the ordinary negative glass. The majority of commercial firms use a good sheet glass, sold by dealers specially for photographic work. This serves all practical purposes.



FIG. 63.

Dry plate glass, if properly cleaned, suits very well for wet plate work.

For cleaning the glass, a lead-lined wooden trough with leaden grooves is the best thing, though expensive. It has the advantage that the plates do not get scratched and chipped, as they do in stoneware troughs, and therefore the glass has not to be so frequently renewed. (See fig. 38 *ante*.)

POLISHING VICE AND BOARD.

A polishing vice (fig. 64) for holding the glass plates whilst being cleaned is very useful, as it saves the chance of finger marks being left on the plates, which are, moreover, cleaned right up to

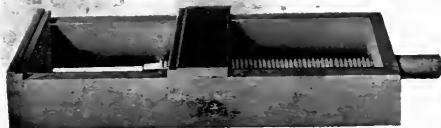

FIG. 64.

the edges. A board covered with American cloth is often used for cleaning glass upon, but it has the disadvantage that the under side of the glass cannot be kept free from the polishing paste or powder. To get over this difficulty, a curved board has been introduced so that the plate is supported on two edges (fig. 65).

BRUSHES.

A flat camel-hair brush for dusting the plates before collodionising should be kept in a handy place in the dark room, either hung up, or provided with a projecting strip to prevent it touching the bench.

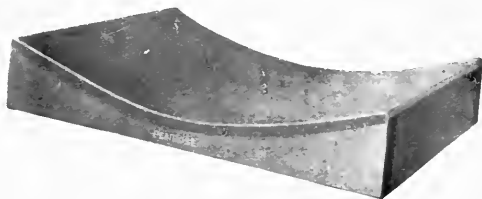

FIG. 65.

For applying the rubber edging to plates, a camel-hair brush is pushed through the cork of the bottle of rubber solution, and on the side of the brush is fastened, by means of small rubber bands, a piece of wood, such as the stalk of a large match, to act as a guide by rubbing against the edge of the plate whilst the brush is run round the margin (fig. 65a).

ARRANGEMENTS FOR EMULSION AND DRY PLATES.

If the dark room is used for collodion emulsion or gelatine dry plates, some slight modification in the equipment will be necessary. We do not advocate working two or three processes together in one dark room—it is always best to have separate rooms, or at any rate separate sinks. For collodion emulsion work very little difference need be made in the arrangements, except to have a separate set of utensils.

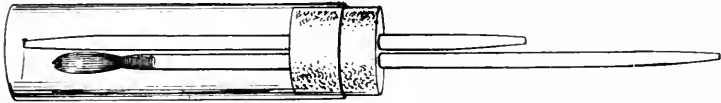

FIG. 65a.

Special care should be taken with this process to ensure freedom from dust. The floor should be laid with linoleum, and the walls and ceiling painted or covered with varnished paper. For gelatine dry plates a set of dishes of all sizes, deep and shallow, will be required for developing, intensifying, etc. Of course, the lighting of the dark room must be arranged to suit the different sensitiveness of the plates, the "Safe-light" lanterns being the most reliable.

CHAPTER V.

THE METAL PRINTING ROOM.

IN using the word "printing" it must be understood that by this is meant the process of transferring the photographic image to the metal plate, and in the room described as "the printing room" are conducted all the operations appertaining to this part of the process. Perhaps a better term would be "exposing." On the Continent the equivalent of the word "copying" is used.

In many small workshops a portion of the dark room is set apart for this purpose, but it would be better to have a separate room, if space can be afforded, for, although printing is sometimes a duty that falls upon the photographic operator, it is best, even where one man does both things, to give him separate rooms, so that the appliances for one process do not get mixed up with those for the other.

A room about the same size as the dark room already described will be sufficient, though for preference it is better that it be larger, as more bench room is required.

It is desirable that besides the room for the preparation and development of the plates—analogous to the photographer's dark room—there should be what we may term a "light" room, that is to say, a room in which the exposure is carried on, as well as such

operations as "burning-in" the enamel, which requires a good light. In this room the arc lamp for printing will be placed. The cutting up and polishing of the metal plates previous to coating may also be done here, and, indeed, this is desirable, as polishing operations done in the dark room are likely to give rise to dust.

The exact arrangement of the printer's "light" room and dark room must depend a good deal on the shape and space allowed, but I will assume that these rooms are on the same floor as the studio, and at the opposite end to the developing dark room. This will enable me to keep to the plan already sketched out, and will be a convenient arrangement, as it is always best to have the printing department near to the studio. The negatives can then be passed to and fro without delay, and the printer is constantly in touch with the photographic operators.

I will suppose it possible to have the "light" room leading out from the studio, and beyond this the dark room.

Starting with the "light" room first, it will be seen that there is first a guillotine for cutting up the metal. This is illustrated in Chapter VIII., Fig. 135. There should be a shelf or two behind for standing up pieces of cut metal, and a box for waste metal under the machine. This waste may soon amount to considerable value in an establishment where a good deal of work is done.

Next comes the polishing bench, for cleaning the metal with pumice, emery, whiting, or such like materials, to free it entirely from greasiness. This will

be practically dry polishing, only a little moisture being used. Where charcoal polishing is resorted to, it should be done on a sloping board in a sink, with water constantly running over the plate.

On the other side of the room is a bench for the printing frames. A shelf underneath should be provided for the



FIG. 66.

empty frames not in use. They are brought up on the bench, and the screw bars, back, and pad laid out so that the negative and plate may be put in and screwed up. After exposure the frame is returned to the same bench in order to take the plate out.

The arc lamp is placed in the centre of the room, and is usually hung near the ground, so that the frames may be placed on the floor around it, and at a suitable inclination. The lamp is furnished with an umbrella-shaped reflector, which throws all the light downward.

Some printers prefer to have the lamp arranged to throw the light in a horizontal direction, with a reflector at the back, and the frames standing on edge on a bench. This naturally limits the number of frames that can be printed to one or two at most, unless a framework is built round the lamp to carry the frames all round, the reflector being removed, as is done in some shops.

It is well in either case to have a hoist to raise and lower the lamp, so as to get the arc in the right position whatever size of frame is being used.

The only other furnishing of the room is a small bench for the "burning-in" stove. It is best that this operation should be done outside the dark room, as it makes the latter very hot, and, moreover, it is easier to watch the progress of the burning-in.

A window at each side of this room is desirable, and outside these windows should be hung a strong shelf on which to place printing frames for daylight exposures, unless the room is on a level with the ground, or with a flat roof, in which case it will be better to have a door, so that the frames may be carried outside.

The corner where the frames are filled and emptied should not be in too strong a light, for although the coating is not very sensitive to momentary exposure to indoor light, there is a risk that it may be unduly acted upon. The corner should be screened off with a hinged window shutter frame covered with yellow fabric, or if the bench immediately inside the dark room is not required for any other purpose, the best way will be to fill and empty the frame there.

The exact way of utilising the bench room must depend on the processes worked. If the inking-up method with albumen bichromate as the sensitive coating is used for line work or coarse half-tone, as well as the enamel process, it will be necessary to provide space for the ink slab and the inking-up stone. This inking-up has to be done in a subdued light, and it should not be too near the sink, or splashes of water may sometimes spoil a print before it is inked.

Passing into the dark room—which, by the way, should be illuminated with a full yellow light, such as can be obtained by covering the window with yellow paper or fabric—the principal provision is a good sink and plenty of bench room. In some dark rooms one sink is made to do duty for whirling, developing, and a variety of other purposes, but this is a mistake. There should be at least a separate sink, or, better still, a circular tub for whirling.

For the latter purpose a good arrangement is a half cask, *i.e.*, a cask sawn in half. Such tubs can be purchased as washing tubs at oil stores. The tub should be placed on a stool at a suitable height, and, if possible, connected up by means of a lead pipe to the waste. Over the tub can be suspended the whirler, whatever form it may be. If of the pneumatic suction or of the clamp-board pattern it can be hung on a hook, whilst the Levy pattern can have its swinging arm permanently attached to the wall.

In some places a large circular galvanised iron pan is used, and a gas stove is placed at the bottom covered with an old copper plate to diffuse the heat. Another idea we have heard of is a funnel-shaped trough, and a perforated water pipe running along the top edge, so that water is running down all the time, and thus keeping it sweet and clean. A stove is placed at the bottom.

A swing arm tap, or a tap placed high up, and with a piece of rubber hose to it for swilling the plate, as is necessary in some methods of coating, is a desirable acquisition, especially as the hose can be utilised for

washing out the tub and keeping it damp. The latter precaution will prevent the joints starting through dryness, and it will keep down the dust.

A gas stove, on a swinging arm, is also a useful feature, as it can be swung under the whirler to dry the plate whilst the whirling is proceeding.

An oven in which to dry the plates after they have been developed is a good thing. Some use it for drying the sensitive coating before exposure.

A rack for the developing trays under the bench or sink, a drawer for cotton wool, and a shelf or two for bottles complete the equipment.

It is immaterial whether the sink is a lead-lined wooden one or an earthenware one. The latter is the most durable and cleanly. A stool should be provided to rest the developing dish upon, and the tap should have a rubber hose. A spray is unnecessary and rather undesirable, as it may wash off a tender film. If whirling has to be done in the sink, it must be fairly deep, or the operator and surroundings will receive the splashes.

For artificial lighting, two or three incandescent lamps should be provided, and a gas bracket for emergencies. The same applies to the illumination of the "light" room in foggy weather and at night.

WHIRLERS.

The first piece of apparatus to be considered in the printer's dark room is the whirler, which is used for forming an even coating of the sensitive solution on the metal plate. Many printers have got their own ideas about whirlers, and favour some particular make-

shift of their own, but there are two or three patterns on the market which have become standardised.

The most popular is the pneumatic whirler, introduced by Penrose and Co. Fig. 67 shows the construction very clearly.



FIG. 67

The end attached to the plate is an indiarubber bulb with a mouth applying suction to the plate. The whole apparatus is very light, and can easily be held in the hand whilst the whirling is done in the sink or the whirling tub, with the plate face downwards. In this way the splashes are retained in the sink, and dust is avoided

owing to the damp surroundings. The whirling can be completed over a stove, so as to dry the plate at the same time.

This whirler cannot be safely trusted for plates over 12×10 , but the same makers have recently introduced another whirler, extending the same principle, for larger plates. Instead of depending on the pressure of the bulb for creating the vacuum between the plate and the sucker, a small brass pump is provided, very similar to a bicycle pump. The sucker is much larger, and will carry a plate 24in. square or over (fig. 68).

In some climates where rubber perishes very rapidly these forms of whirler are unsuitable, but the rubber may be replaced by a straight bar with two screw clamped clips sliding on it to hold the plate.

Another modification is to use a "force by plumbers for sinks. It is thought holder gives a better the plate, is inferior, volume of air out before formed, and there is of leakage at the

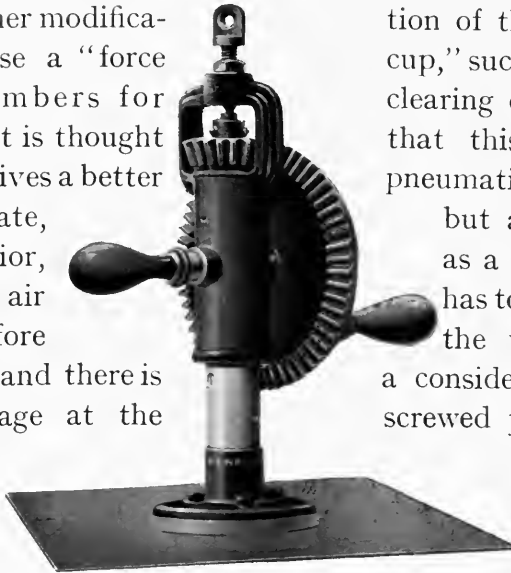

FIG. 68.

tion of this whirler cup," such as is used clearing drains and that this form of pneumatic grip on but actually it as a larger volume has to be driven the vacuum is a considerable risk screwed joint.

It is also possible to have two springy pieces of wood or metal springs arranged to form a clamp when pressed open, and the plate inserted between.

The Levy whirler (fig. 69) is a very good fixture for large plates. It is attached to the end of a swinging bracket, with the other end fixed to the wall. The whirling portion is pivoted on a horizontal axis, so that the plate can be face up for coating, and then turned face down for whirling. This form of whirler can be fixed over a tub, as already described, and the swinging arm permits it to be swung from the tub over a stove for drying off.

The turntable whirler (fig. 70) embodies a very good principle, but its disadvantages are that as the plate has to be whirled face upwards it is liable to attract dust ; further, that unless there is a guard round it there is a great deal of splashing about the room and upon the operator ; also the plate cannot be quickly detached. Its chief advantage is for large and heavy plates, and for lithographic stones when the latter are used for direct half-tone printing. When fitted inside

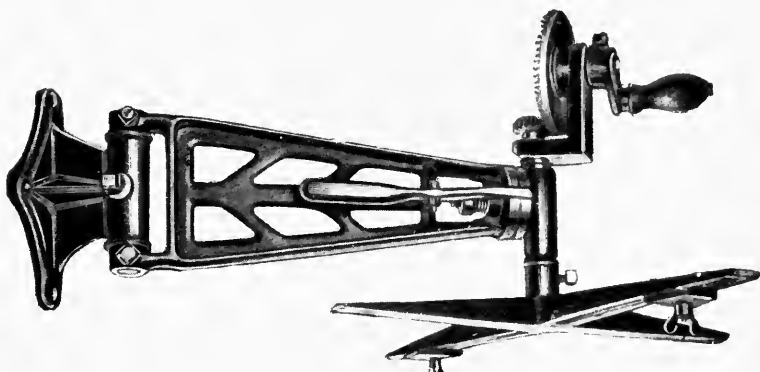

FIG. 69.

of a circular iron box with a trough round to catch the surplus solution, a small stove inside to dry the plate whilst being whirled, and a glass lid to keep out the dust, this form of whirler becomes very efficient, and the author has seen such whirlers capable of taking a plate up to 60×40 in.

The most ingenious whirler of all is Penrose's patent cone whirler (fig. 70a). The plate is dropped into the cone horizontally, and touches with its corners the inside of the cone. The centrifugal force holds the plate firmly in its place without any clamps. All splashes are

retained in the cone, and dust can be kept out with a lid. The spindle of the whirler is a hollow shaft with a Bunsen burner at the bottom, so that the heat rises into the cone and dries the plate.

Most other whirlers in use are modifications of one or other of these principles, and need not be particularly described.

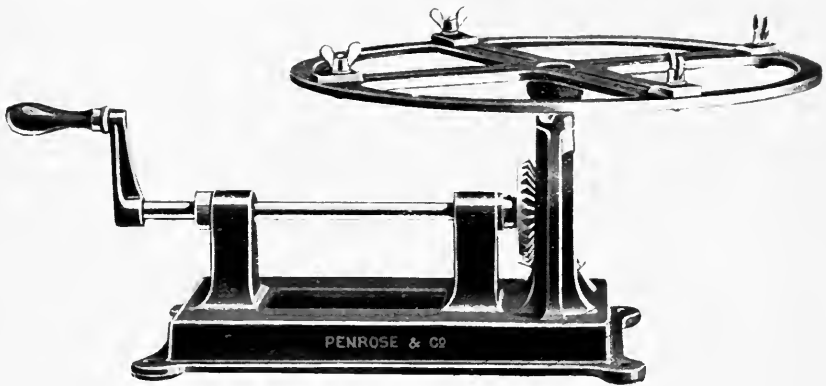

FIG. 70.

STOVE.

A gas stove of the ordinary circular pattern, but one that will give a good spreading flame, is required near the whirler for drying off the plates. The gas connection should have a tap for regulating the flame. If the fitting already exists without a tap, it will be possible to put a spring clip of some sort on the rubber tube to attain the same object.

Some printers prefer to place a plate of sheet iron over the stove to disperse the heat, instead of allowing the naked flame to play on the coated plate. It should be placed two or three inches above the flame.

UTENSILS.

For the preparation of the sensitive solution used by the printer, it is advisable to have an entirely separate set of utensils, as the fish glue, albumen, etc., are very "messy" and difficult to clean off if the vessels are required for other purposes.



FIG. 70a.

A large basin, such as the household pudding basin, for mixing is required, also one of the rotary egg whisks which are sold for household purposes. Although there are plenty of other ways of beating up albumen, this is perhaps the quickest and most effective.

FILTERS.

The filtering is also a troublesome operation in the case of fish glue, and various devices have been adopted. The simplest but least effective way is to plug the neck of a funnel with wet cotton. This serves very well for the albumen bichromate solution for line work, but it is not good for fish glue. If the latter is too tight the solution will not go through; if too slack the filtration will be imperfect. Paper is practically useless for fish glue. Glass wool does

not trap the fine sediment sufficiently. Washleather soon gets tough and non-porous. Swansdown, muslin, cheese cloth, and such like materials have been tried without becoming popular. The author has found nothing better than coarse white flannel or felt, cut and folded like a filter paper. It must not be too thick nor too close in texture. After use the flannel should be thrown into a dish of water, and when wanted again well wrung out. If allowed to get dry it soon becomes useless.

The most effective way of filtering, though it is slightly more troublesome, is to have a vacuum filter (fig. 71). The effect of the water rushing through the

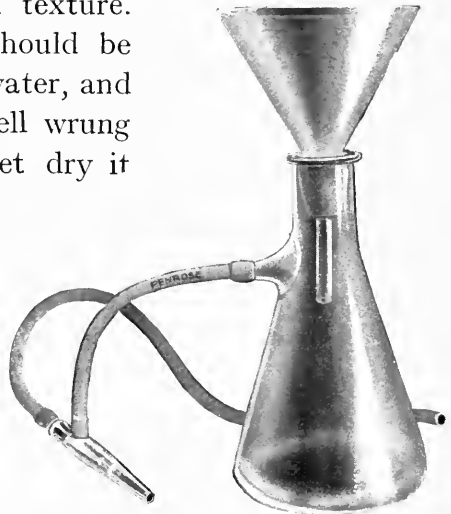

FIG. 71.

small glass tube is to draw all the air from the lower vessel, and the atmospheric pressure on the liquid in the funnel then drives it through the filtering medium, which may be, in this case, absorbent cotton. To prevent it being sucked into the neck of the funnel it is usual to have a perforated porcelain filter plate to support the cotton; this spreads the cotton out to give a larger filtering surface.

When filtered, the glue should be transferred to a wide-mouthed bottle. No cork or glass stopper should be used, as it would become cemented tight into the

neck. A piece of cardboard or glass laid over the mouth to keep the dust out is all that is required.

BOTTLES, MEASURES, ETC.

For pouring the solution, a lipped beaker or wide-mouthed measure is better than a bottle. A collodion pouring bottle would be excellent were it not for the glue cementing up the neck and rendering it impossible to remove the cap or pouring neck.

A few measures, bottles, stirring rods, a mortar and pestle, and at least three dishes will complete the outfit for the printer, so far as his dark room is concerned. One of the dishes is used for water developing, another for the dye solution, and another for methylated spirit used in drying.

PRINTING FRAMES.

In the printer's "light" room the printing frames are the first consideration. There have been innumerable attempts to improve on the screw pressure printing frames originally adopted by process workers, but the fact remains that to-day, as fifteen years or more ago, the frame with the greatest number of screws at the back is the most used. The screws were formerly of beech-wood, threaded into beams of the same material, but of late years iron screws in iron bushes have been the most popular. A frame which has practically become a standard pattern is shown in fig. 72.

These frames are very heavy, and strongly constructed of oak, with iron clamps at the side to take the thrust of the pressure. The boxes are always

larger than the negative, the front being fitted with thick plate glass, against which a negative of any size smaller than the box may be laid. The frames are made in various sizes, generally one inch larger each way than the standard photographic sizes. The plate glass front varies in thickness from half an inch in the smallest to one and a quarter inches thickness in the largest sizes. The number of frames necessary is dependent on the quantity of work, and

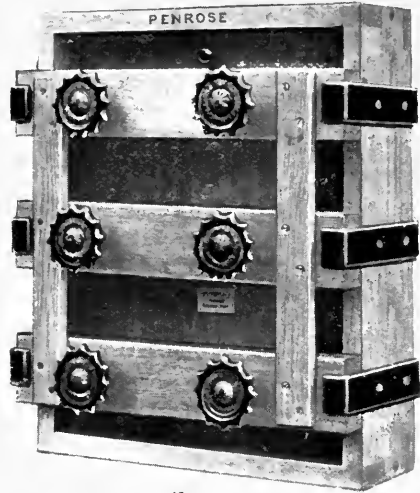

FIG. 72.

the speed with which it has to be turned out. At least two frames should be at hand, so that whilst one is being exposed another is being got ready. It is useful to have one or two small size frames as well as those the full size of the largest plate the camera will make, as the small frames are quicker and easier to handle.

Amongst other styles of frames which have been recommended from time to time is one with the pressure applied with wedges, another in which an air cushion was inflated at the back of the plate, and yet another in which hydraulic pressure was applied. Frames with a single central screw and a metal "spider" to distribute the pressure have been tried, but have never been successful in overcoming the prejudices of the printers. A much nearer approach to perfec-

tion in a screw frame is one introduced by Penrose and Co. (fig. 73), in which there are two screws,

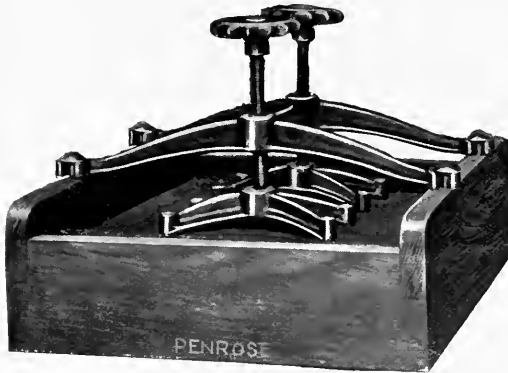

FIG. 73.

threaded into a light steel frame which crosses the back of the box, the points of the screws pressing against iron "spiders," which well distribute the pressure. There are also iron battens to strengthen the back of the frame in the larger sizes.

Fig. 73a is a frame for printing direct on to a lithographic stone.

In America, the "Ideal" frame (fig. 74) is very popular. The wooden back of the frame is covered with cylindrical sections of hard rubber, against which the pressure bars are forced by means of a cam-shaped hook linking into a staple at the side.

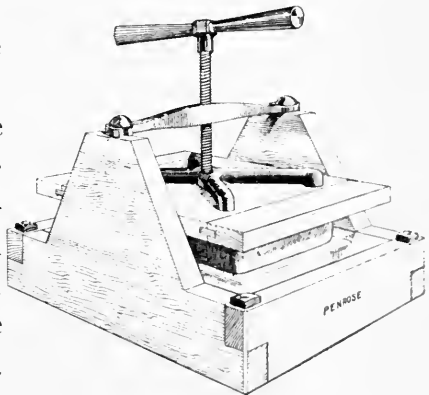

FIG. 73a.

McLaughlin's frame (fig. 75) is a distinctly novel one, as the front glass is hinged and the filling is done the reverse way of the ordinary frames, from the front

instead of the back. Fig. 76, the vacuum frame, is a novel construction which has been found very effective. The pressure is exerted by the atmosphere by exhausting the air by means of a vacuum pump. A pneumatic cushion frame introduced by Penrose and Co. has also been found very effective.

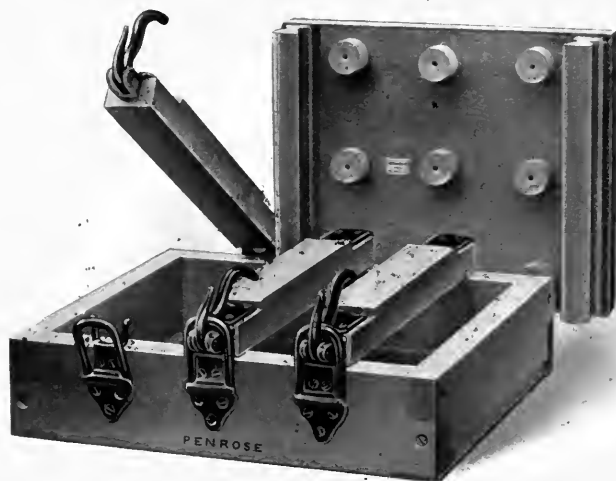

FIG. 74

Whatever form of frame is used, a thick felt pad must be placed between the metal plate and the wooden back. Rubber is sometimes used instead, but it is expensive, and deteriorates very rapidly.

ACTINOMETER.

When the exposure is made to electric arc light it can be timed very accurately, but for daylight exposures it is best to use an actinometer. The simplest form is as fig. 77. This consists of strips of paper so arranged as to form steps, No. 10 being ten thicknesses of paper. This forms a mask, behind which a piece of sensitive paper is placed (ordinary p.o.p.) When a certain

number (determined by experience) is visible on the sensitive paper, the plate will be fully exposed. An improved form made by Penrose and Co. has a glass mask with a film graduated in different degrees of density on it.

BURNING-IN STOVES.

For what is called the "burning-in" of the plate after development, a good stove is required. Whilst any ordinary gas stove will do which has a powerful and wide-spreading flame, it may be pointed out that

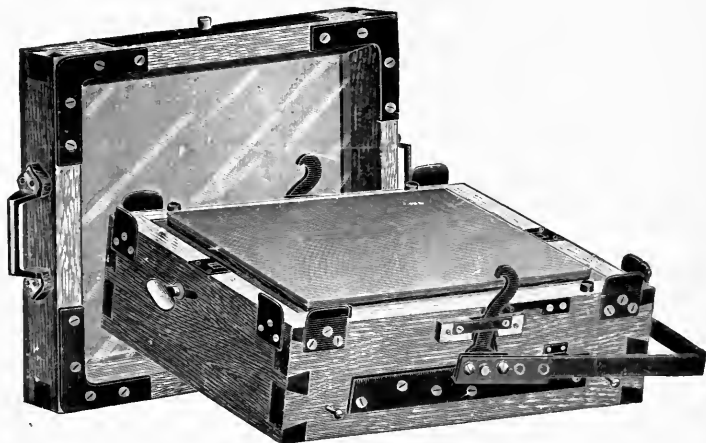

FIG. 75.

there are now several stoves on the market specially constructed for the purpose. Penrose and Co. have a stove with three long straight burners (fig. 78) connected together, enabling very even heating to be performed. Recently the same firm have introduced a stove which can be used for any photo-process. The iron plate on the top is hinged, so that the stove may either be used as a hot plate for line etching or

photogravure, or the top may be lifted up to permit of using the apparatus as an open stove for the "dragon's blood" process, or for burning-in the enamel.

It may here be mentioned that it is not considered practicable to use a hot plate for these two latter processes, owing to the great heat required and the



FIG. 76.

slowness with which the heat would be applied.

For economy the stoves should be provided with a cut-off and bye-pass, so that only a small pilot light is left burning whilst the stove is not in use (fig. 78a).

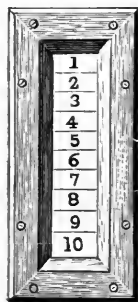

FIG. 77.

PLATE TONGS.

The plate is handled with plate tongs, which are practically large pliers. There is an improved form with broad nose (fig. 79), which prevents the plates being bent so much in the heating operations. The tongs are best with the handles covered to prevent the hands being burned. It has been suggested to have a kind of gridiron for supporting the plate upon whilst heating, but it must be pointed out that any iron in contact with the plate absorbs and abstracts heat from it, causing patches which are not fully burnt-in. Ovens have been tried and have not been found quite successful. The almost universal practice is to use the open stove.

COOLING SLAB.

On the bench near the stove should be an iron plate with a piece of thick asbestos on it to lay the plate upon and allow it to cool. Some use the naked iron plate, a lithographic stone or a piece of wood without

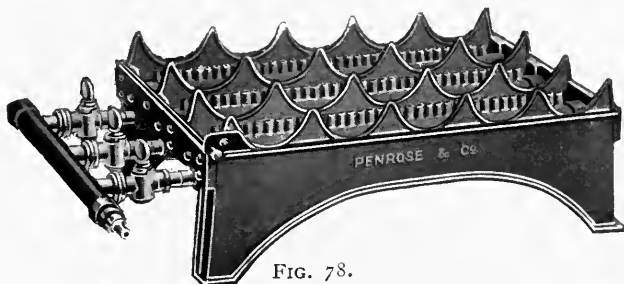

FIG. 78.

any ill effect. It is not right, however, to cool the enamel plate too suddenly, as the film may be

cracked and disintegrated by the sudden contraction of the metal, and the latter will be softened.

The best way is to cool the plate in an iron press, which will at the same time take any buckle out of the plate.

POLISHING BOARDS, ETC.

For polishing metal plates preparatory to coating, similar appliances to those for cleaning glass may be used. The wooden



FIG. 78a.

vice already described (fig. 64) is an excellent thing for small sizes, and for larger ones the curved board (fig. 65), though this may probably mean bending the plate in very large sizes if any pressure is used. A flat board covered with American cloth will also do very well. For charcoal polishing the best thing is a sloping flat board in the sink, with a narrow strip of metal tacked on to it, against which the plate rests.

A modification of the old-fashioned screw vice is to have a box with open top, and a couple

of rails across, to rest the plate on. One rail is fixed and the other moved up into notches cut at various distances. A rebate, corresponding to the thickness of the plate, is cut in the meeting edges of the bars, so that the plate was held from slipping off. The idea is right enough if the plates are cut to standard sizes, but as the zinc is cut to any odd measurements to fit the picture, such an arrangement would hardly be practicable. There is no reason why the vice should not be combined with the open box to receive the surplus powder.

GRAINING BATH.

For some methods of half-tone we require a graining bath. This may be either a porcelain dish on a rocker or a small etching tub. The porcelain dish can be made use of as a makeshift, but the plate is liable

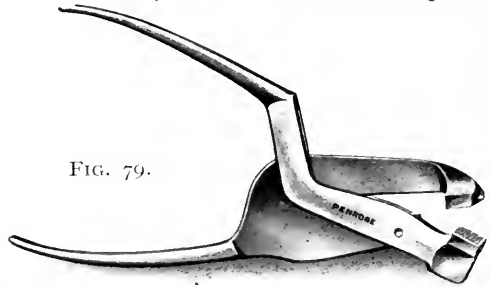

to slip about, and an uneven grain is produced unless the plate is completely submerged. The best arrangement of all would be a light wooden tray with a rocking arrangement actuated by a small clockwork or electric motor, or a pendulum. If the tray is a wooden one it must, of course, be pitched or coated with other material to stand the acid. The tray should be as large again in area as the largest plate to be used.

INK SLABS.

As the albumen process is sure to be used either partially for half-tone or wholly for line work, there will be required on another part of the bench well away from the stove and sink a couple of litho stones, one for the ink and the other with a pad of sheet rubber on it, the object of this being to hold the plate from slipping about whilst it is being inked, the stone providing a firm bed.

Behind the ink slab or underneath the bench should be a cupboard with a hook inside, or some other means of suspending the composition roller used for this process to keep it from contact and free from dust. In the same cupboard may be kept the ink. The roller will keep better if there is a little ventilation in the cupboard.

ROLLERS.

The roller should be of the letterpress kind (fig. 80), with forked handle, and the composition of a water-resisting nature, and not too soft. If tacky, it will stick to the plate and pull the film off. A tacky roller may be improved for immediate use by rubbing it

all over with powdered alum applied with the palm of the hand. New rollers suffer badly from tackiness caused by damp and also from moisture exuding from the composition. The alum, being hygroscopic, absorbs this moisture. To make a roller less susceptible to changes of temperature, it should first be cleaned free from grease or ink by means of turpentine, then washed with methylated spirit applied with a sponge, and when dry, sponged again with a solution of ordinary alum, chrome alum, or tannic acid.

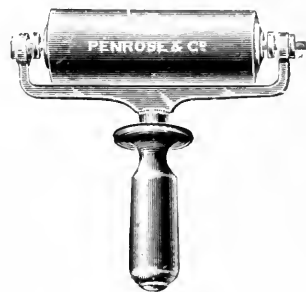

FIG. 80.

Indiarubber rollers can be used instead of composition ones, but it is difficult to keep them in good condition. They are apt to become hard, dry, lumpy, or cracked. They should be cleaned with paraffin to remove the ink, and then sponged with water containing a little alkali, such as washing soda, ammonia, or potash, or a little soapy water. Oil is very injurious to rubber, and benzine or naphtha dissolves it.

The best form of indiarubber roller is Turner's patent pneumatic roller (fig. 81). It is hollow, and inflated like a bicycle tyre to any degree of hardness, yet always retaining a nice elasticity.

Some practical men use a good lithographic leather roller, with very dry close skin and fine nap, for rolling up albumen prints. The ink must never be allowed to become too thick on such a roller, and it must never be thinned down with turpentine, as is usual

with the composition roller—it must be used full strength, or, at any rate, only thinned by careful mixing with a little grease or thin varnish. It is better

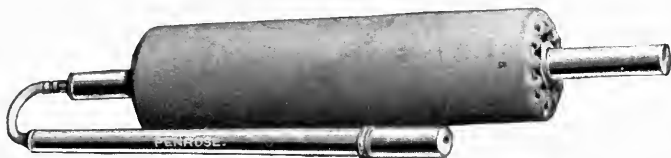

FIG. 81.

to have two rollers, one being used to get the ink well distributed, the other for applying the ink to the plate. The author, however, does not recommend leather rollers to be used, except by those who are accustomed to them and expert in their manipulation. Leather rollers, moreover, want to be in constant use to keep in good order.

INK KNIVES.

A set of ink knives are requisite accessories to the ink slab. Fig. 82 is a palette knife for mixing, fig. 83 an ink knife for taking the ink out of the tins, and



FIG. 82.

fig. 84 a "push" knife, so called by reason of its being pushed forward to scrape the ink off the slab. A little bridge of wood to rest them on when smeared with ink is an aid to cleanliness, and may

be easily constructed by anyone. A cover for the ink slab, in the form of an inverted box, should be



FIG. 83.

provided, as it is most important to keep the slab free from dust.

For the dry enamel process, and for photo-lithographic transfers, some additional appliances will be



FIG 84.

necessary, but these are best left to be described in the instructions for these processes.

CHAPTER VI.

THE ELECTRIC LIGHT INSTALLATION.

IN large towns and cities it has now become so general to do all work by means of the electric light that it seems necessary to indicate the points to be considered in making an installation. If the studio is near the mains of an electric supply company, matters are fairly easy, and it is most economical to take the supply in this way instead of generating it oneself, especially as most supply companies give special rates to photo-engravers.

When it is not possible to get a supply from the street mains, it will be necessary to have a steam, gas, or oil engine, and it is usually requisite to have also a battery of accumulators, in order to get a steady current and to maintain the supply when the engine is stopped.

The exact horse-power required depends a good deal on the efficiency of the dynamo. If, for instance, the efficiency is eighty per cent., we must add twenty per cent. to the power we estimate the lamps to be taking.

Again, the power depends on the arrangement of the lamps, whether in "series" or "parallel." If a 60-volt dynamo is used, there will be no alternative but to run "open" type lamps in "parallel," that is to say, each with its own separate circuit and switch, because each lamp requires about 45 to 50 volts to

maintain its arc, and we require the surplus 10 volts for the steadying resistance. Two lamps in "series" would require 100 volts, and three in "series" 150 volts; but whereas in the case of two or three lamps in "parallel" 50 or 75 ampères would be required at 60 volts pressure, only 25 ampères would be required at 100 or 150 volts pressure for two or three lamps in "series." It is usual to run "open" type copying lamps at 25 ampères, and printing lamps at 30 ampères and upwards. Since the introduction of "enclosed" arc lamps, the nature of which will be explained presently, all the above conditions have been changed. The voltage has to be higher and the ampèrage lower.

It is somewhat difficult to explain these terms "volts" and "ampères" to the reader who is unacquainted with electrical matters, and it will be sufficient to define "volts" as the pressure necessary for effective working in the same way that we refer to pressure of water, gas, or steam; and we may define "ampères" as the quantity of electrical energy flowing, just as we may have a large quantity or a small quantity of gas issuing from a pipe, and thereby get a large or a small flame, whilst the pressure of gas from the company's mains remains the same. It follows that the greater the ampèrage the greater the intensity of light provided. Of course, the lamps must be constructed and adjusted so as to take full advantage of the increased current.

One fact must be borne in mind, viz., that whatever the ampèrage may be, the voltage for "open" type lamps must remain constant at about 45 volts per

lamp on continuous current, and about 35 volts on alternating current. The latter current is not likely to be used in private installations, so that these remarks may be taken throughout to refer to continuous current, unless otherwise stated.

Coming back to the question of the best arrangement of lamps—"series" or "parallel"—it will now be seen that this depends a good deal on the voltage. At 60 volts, "parallel" arrangements can only be used; at 100 volts it would mean a great waste of energy to put them in "parallel," as 50 volts or more would have to be dissipated by means of a resistance coil with each lamp, and a further consideration would be that the dynamo would not give out a sufficient ampère. Here we are referring to "open" type lamps.

This rule must be remembered: In "parallel" working the volts remain practically constant for any number of lamps, but the ampères add up. If one lamp requires 25 ampères, two lamps require 50, and so on. In "series" working the volts add up whilst the ampères remain constant. If one lamp requires 45 volts, two require 90, and so on, but the ampères are the same for any number of lamps, as the current passes from one into the other.

This point is important when estimating the power required to drive a dynamo, and also in determining the cost of the current from the street mains, because the volts and the ampères multiplied together form another electrical quantity termed "watts." Now, 746 watts are equivalent to 1 h.p.; hence it is fairly easy to understand how the horse-power necessary to

run arc lamps is arrived at. For example : Two arc lamps consuming 25 ampères in series on 100 volts are taking 2,500 watts, and if we divide this number by 746 we get a quotient of 3.35, so that we are justified in saying that, allowing for efficiency losses in the dynamo and engine, we cannot do with less than $3\frac{1}{2}$ h.p., and that would be cutting things rather fine. Of course, the power can be reduced by running lamps of less ampèrage, but that means longer exposures, and a low intensity of illumination does not have the same effect on the sensitive plate in the shadow dots, even when the exposure is prolonged.

When the current is taken from the street mains, the supply companies in this country charge a certain rate per Board of Trade unit. This consists of 1,000 watts running for one hour. For example : A pair of 25 ampère lamps, on 100 volts, allowed to run for one hour would consume $2\frac{1}{2}$ units ; or if allowed to run for only half an hour $1\frac{1}{4}$ units. If the price is 4d. per unit, the cost of running a pair of 25 ampère lamps on a 100-volt supply for one hour will be 10d. The charges, however, vary in different towns and districts, and in some towns even so low a rate as 1d., $1\frac{1}{4}$ d., and $1\frac{1}{2}$ d. per unit is charged as a special rate to photo-engravers.

Of late years it has become usual for the electric supply companies to provide their current at 200 to 220 volts, and in such case there would be a considerable waste in putting a pair of "open" lamps in series on such a circuit. Four lamps in series would cost no more than two to run, but if the consumer has no use for

the two extra lamps, his case is best met by having special lamps which take up a higher voltage. There are now on the market "enclosed" lamps which meet this requirement.

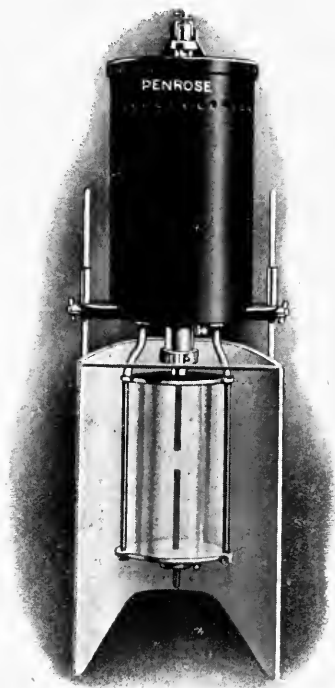

FIG. 85.



FIG. 85a

ENCLOSED ARCS.

So far we have dealt only with the ordinary or "open" type of arc lamp, in which the arc is naked—not enclosed in any glass bulb or globe. Within the last few years there have come into use what are known as "enclosed" lamps (fig. 85). In these the arc is enclosed in a glass cylinder or bulb, and the ends of the same fit so closely that the air inside

is soon almost consumed, and is not entirely replaced while the carbons are burning. The arc then burns in a gas formed by the products of combustion. The result is that the carbons are consumed more slowly than in the open arc. The construction of the lamp is such that about 75 to 80 volts on 100-volt circuits, or 140 to 150 volts on 200-volt circuits and over, are taken up, resulting in a longer arc, whilst at the same time less current is required; but this long arc is very susceptible to draughts, and would constantly go out unless the arc is enclosed by a glass cylinder. This is the object of the glass enclosure, but incidentally, as we have shown above, it saves the carbon consumption. Such lamps are run with about 8 or 10 ampères, and it is recommended to run them in parallel in order to get the highest voltage across the arc lamps. The enclosed arc being richer, however, in violet rays is more actinic, and, moreover, the arc, being longer and more flaring, gives a greater diffusion of light. A further advantage of the "enclosed" arc is that the consumption of the carbons is very slow. Both carbons are alike in diameter, and burn with flat ends, instead of having pointed ends as in case of the alternating current, or a pointed end on one and crater on the other as in the continuous current arc. "Enclosed" arcs can be had for either continuous or alternating current. A new form of "enclosed" arc with flat front of heat resisting glass is shown in fig. 85a.

CARBONS.

It may be here mentioned that in continuous current "open" arc lamps the top or positive

carbon is thicker than the bottom or negative carbon, the rule being that the top one has twice the area of cross section of the lower. The reason of this is that the positive carbon is consumed twice as fast as the negative. The top carbon is always "cored"—provided with a core of softer material—which tends to assist the formation of the crater, and keep it central. The bottom carbon is solid, and burns to a long tapering point. In the alternating current lamp both carbons are of the same diameter and both are cored. There is no positive or negative, or, correctly speaking, each carbon alternates from positive to negative, being positive for a moment, then negative, and repeating the cycle of change for 50 or 100 times per second. That will roughly explain the terms "periodicity" or "frequency" of the alternating current, which is the number of times the current makes the cycle of change from positive to negative. In some towns it will be 50, in others 80 or 100 cycles per second, and it is necessary in ordering lamps for alternating current that the "periodicity" should be stated, as a lamp arranged for 50 cycles will not work on 100 cycles. The voltage should also be stated in ordering lamps whether for "continuous" or "alternating" current.

In the "enclosed" arc lamps though the top and bottom carbons are both of the same diameter, the bottom carbon, projecting inside the lamp, is only about one-fifth the length of the top, as it does not burn away so fast. The usual way of trimming the lamps is to put any length of carbon in the bottom holder,

and only to insert it about 2in. up inside the lamp. If the top carbon will not reach it when the current is off, it should be replaced by a new carbon or by the unconsumed end of the top carbon, which will generally be about 5in. to 6in. long. Solid carbons are generally used in "enclosed" lamps, but cored ones are recommended by some makers, and are also used for coloured flame effects.

It is desirable to order a supply of carbons with the lamps, as there is a great difference in the quality of carbons, and bad ones may entirely neutralise the adjustment of the lamps, besides hissing, spluttering, flaring, and possibly cracking and crumbling away, doing anything, in fact, but giving a steady arc. A good pair of carbons is almost silent, and the residue from them is in the form of a very fine black dust.

ADJUSTMENT OF ARC.

The length of arc—equivalent to the distance between the carbon tips—has a very important influence on the amount and character of the light, as also has the accurate centring of the carbon points to one another. In "open" arc lamps a long arc will give a violet light with a flaring yellowish flame round the carbons. A short arc will cover up the white incandescence from which issues the most actinic light, and the arc will for the most part consist of red and yellow fringes. It has been well established by scientific investigation that the best light comes from the crater of a continuous current "open" arc, and this light most nearly approaches the qualities of

sunlight. It is accordingly a good plan to set the carbons so that the crater throws the light forward, either by inclining the carbons in opposite directions or by setting the bottom carbon a little in advance of the top.

The length of arc is usually about $\frac{3}{16}$ in. in the case of "open" arcs, but for "enclosed" arcs it may be anything up to 2 or 3 in., or more, the length of arc depending on the voltage. It is about 1 in. on 100 volts, and 2 in. on 200 volts. It is a good plan to have a screen of red and green glass combined, so that the arc can be viewed. Messrs. Penrose and Co. sell a little pocket folder for the purpose—very much like a pocket magnifier, but with coloured glass discs. It is not wise to allow one's naked eyes to be subjected to the glare of the arc light, and, indeed, it will bring on temporary blindness and great pain, especially in the middle of the subsequent night, if persisted in. The lamps should be shaded with reflectors, and if the arc is directly examined a pair of smoke-tinted goggles should be put on, or some form of coloured glass screen held before the eyes.

A point to be remembered in placing the lamps in relation to the copyboard is that with continuous current lamps the light is thrown downward from the crater of the arc, the best rays making an angle of about 60° to the axis of the carbons. The lamps should accordingly be hung so that the arc is above the centre of the copyboard, the best position being found by trial, it being quite easy to see when the board is well illuminated. Any reflector surrounding

the arc is best inclined forward. In the alternating current arc the light issues in radial lines equally above and below the arc, which should consequently be placed opposite the central line of the copyboard. The reflector should be placed vertical.

REFLECTORS.

The form of reflector is somewhat important. The best possible is one not quite of a parabolic shape. If quite parabolic, and if the light were placed at the focus, the rays would emerge in a parallel beam, and would only give a small disc of illumination on the copyboard. But by making the reflector a combination of a sphere and a parabola, and placing the light nearer in than the true focus, a divergent beam is obtained, subtending an angle of nearly 90° , the copyboard being consequently very evenly illuminated.

Messrs. Penrose and Co. first introduced these semi-parabolic—as we may call them—reflectors, and have been very successful in adapting them to “open” arc lamps of various patterns (fig. 86). There is no doubt also a great gain in concentrating the light and throwing it forward to the copyboard, instead of merely screening the back of the lamp with a sheet of tin or zinc, as was done formerly. Still, the latter plan is better than nothing at all, as it prevents stray

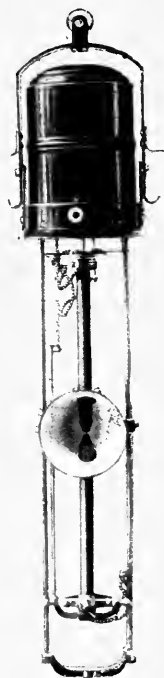

FIG. 86.

light getting into the camera. For "enclosed" arcs the form of reflector shown in fig. 85 is generally employed.

Whatever reflector is used, it must be dead white inside. In most cases a coat of whitewash serves very well. Some operators use aluminium paint. A porcelain enamelled reflector is good if sufficiently far away from the arc. Bright reflecting surfaces do not illuminate the copy evenly.

LAMPS.

For a printing lamp, the form of reflector shown in fig. 87 is generally adopted, and the lamp is usually made to take a larger current, *e.g.*, 15 or 20 ampères in "enclosed" arcs.

In regard to the choice of lamps, some care must be exercised to get a suitable type. If left to the electrical contractor he may put in a form which may be very well suited for street or general



FIG. 87.

lighting, but not fitted to the needs of the process worker. The lamp itself may not have been made to carry so heavy a current as the process worker requires, and although the lamp may be adapted by changing

the coils and carbon holders, it is never so satisfactory as a lamp designed for the current it is intended to carry. Again, the street lamps are not expected to be so sensitive in feeding the carbons together as they are consumed away, and in some cases this operation is performed in jerks, or, in popular parlance, by "fits and starts." Another disadvantage is that these lamps are usually big and clumsy with respect to the case at the top of the lamp, so that where there is little head room the lamps cannot be suspended high enough. It may also be difficult to remove the case in the event of anything going wrong.

One most important point to bear in mind is that whatever type of "open" arc lamp is selected, it must be one in which both the carbons move together -- what is called a focussing lamp. In some lamps the bottom carbon is fixed, and only the top one moves. In such a case it would obviously be useless to have a parabolic reflector, as the arc could never be kept central in it, and even without a reflector the lamps would have to be raised and lowered as the carbons were burnt away. These remarks do not apply, of course, to the "enclosed" arc.

The form of "open" lamp to be recommended, therefore, is known to electricians as a "differential self-focussing lamp." The word differential implies that there will be a pair of coils in the lamp, which will balance against each other, any sudden change in the one being compensated in the other. One of the coils will be of thick

wire, known as the "series" coil, through which the whole of the current will pass on its way to the carbons. The other will be of thin wire, known as the "shunt," and will form a byepath for the current. If a large amount of current passes through the "series" coil, there will be a correspondingly large current in the "shunt," and as they cause their magnets to rise and fall like a scale beam, the one will balance the other, and the feeding motion will be very sensitive and gradual during the whole time the lamp is working. The simpler the mechanism in the lamp the better, but it must at any rate be sufficient to ensure a uniform feed. In the "enclosed" type lamps the feeding mechanism is usually actuated by a "series" coil only, and the top carbon is held in a sliding clutch. When the switch is off the carbon points are together, but as soon as the current is switched on the magnet inside the "series" coil draws the top carbon up, thus starting the arc. When the carbons burn away the magnet drops, and allows the clutch to slip, so that the top carbon touches the bottom one. This sends a rush of current into the "series" coil, the magnet is pulled up, and the arc is again formed. There is usually a balance weight working against the magnet on a rocking lever. If the lamp "pumps," it can be regulated by the adjustment of this weight.

Operators should endeavour thoroughly to grasp the principle of the feeding mechanism of their lamps, and to trace out the path of the current, so that they may readily know what to do in case the lamp "sticks" in any way.

Carbon holders of "open" arc lamps should preferably have some form of spring clamp, as the grip slackens when the holders get hot, owing to expansion of the metal. A loose contact will often cause sparking, and eventually "arcing" on to the holder, with the result of its being fused and rendered useless. It is advisable to tighten up screws when the lamps have heated up, and the carbons will then remain tight. The bottom carbon holder, at least, should have a ball and socket joint for more readily centring the points of the carbons. No such adjustment is needed in "enclosed" lamps.

A word must be said as to the necessity of having two lamps to illuminate the copy evenly. As the lens must point centrally to the copy, it is impossible to place one lamp in the best position for obtaining the maximum amount of light, *i.e.*, opposite the centre of the picture. It must accordingly be placed at one side, with the result that if the copy is more than a foot across, the further side is unevenly illuminated, and the reproduction shows that portion of less density on the negative, the dot formation in the half-tone being entirely different on one side from that on the other. There may also be trouble due to reflections from the surface of the copy if the latter is at all glossy, or from the grain of the paper if rough. These troubles are worrying enough with two lamps at times, and will be greatly increased with one lamp. Of course, a good deal may be done by the use of a reflector on the opposite side to the lamp, or by having the lamp on a travelling pulley, so as to push it over

to the opposite side midway in the exposure. But these are at the best makeshift arrangements, which may result in many spoilt negatives.

The plan which is universally adopted is to have two lamps, which are usually placed about two feet from the board, and about four to five feet apart. These distances have to be varied for very large copies on the one hand, or extremely small ones on the other. The points to be studied in placing the lamps are: (1) To see that they cause no shiny patches on the copy, which can be discovered by examination of the image on the ground-glass, or by placing the eye at the position of the lens, which is perhaps the better course, as the reflections sometimes cannot be seen on the ground-glass; (2) to have them as near as convenient to the copy, remembering that doubling the distance makes the intensity one-fourth, trebling the distance one-ninth, or, as it is expressed scientifically, "the intensity of illumination varies inversely as the square of the distance"; (3) to see that the illumination is equal from both sides, which may be determined by holding a pencil in the centre of the copy, and noticing if the two shadows cast by the lamps are equal in depth of shade.

For illuminating a very large copyboard, it is a good plan to have four lamps, two being above and two below the centre line of the board. If the current is continuous, it is further a good plan to reverse the carbons in the bottom pair of lamps, and reverse the order of the cable connections, so that the bottom carbon becomes the positive. In this way the light is

thrown upwards from the lower lamps and downwards from the upper ones, ensuring a very even illumination. This also is a very good arrangement for dealing with a 200-volt supply, as all four lamps can be run in series, and cost no more to run than two lamps.

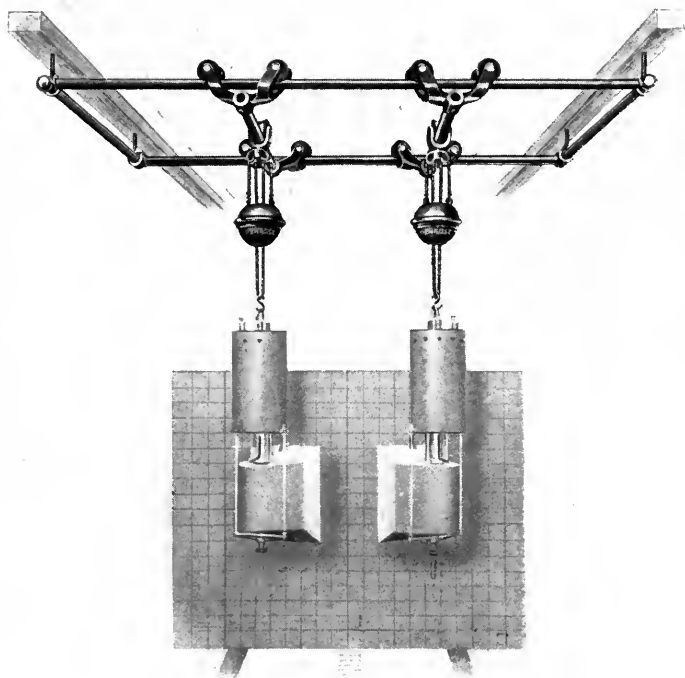

FIG. 88.

TRAVERSING GEAR.

To facilitate the adjustment of the lamps, it is desirable to have a traversing gear, such as herewith illustrated (fig. 88), if a suitable fixing for the same can be obtained overhead. This enables the lamps to

traverse to and from the board independently or together, also permitting them to be moved nearer together or further apart, and provides for raising and lowering by means of a counterweight, so balanced that the lamp will stop at any point.

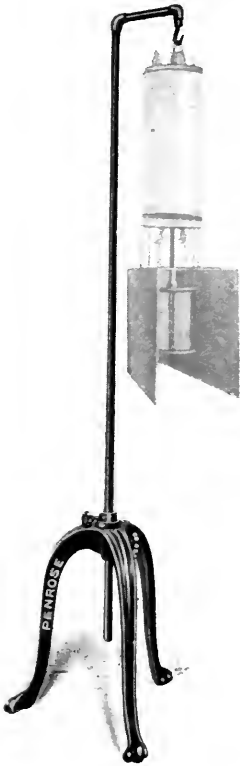

FIG. 89.

LAMP STANDS.

In many studios where it is inconvenient to have an overhead gear, a floor standard is used for each lamp, and some operators prefer one in any case. A stand certainly has the advantage that it can be moved about to any part of the studio. A good type of stand which permits of the hanging type of lamp being used is shown in fig. 89. The rod can be raised and lowered, and a clamping collar on the rod enables the lamp to be swung round without lifting the stool.

In America the form of lamp illustrated in fig. 90 is very generally used. The exact pattern will vary with different makers, but all are alike in principle. These lamps are, as a rule, much dearer than the hanging ones, and have no advantages, except, perhaps, in the fact that the lamp can be tilted. They are also now made in the "enclosed" style, with a similar stand.

PRINTING LAMPS.

For printing the photographic negative on to the metal plate, the same lamps may be used, but it is generally more convenient to keep the printing department separate, and to use a single lamp of higher power. Not less than 30 ampères is advisable with "open" arcs, and 40 or 50 ampères are better if quick work is required, but with "enclosed" lamps such as fig. 87 15 to 20 ampères are sufficient. Although it is quite the usual practice to use one lamp only for printing, it means an absolute waste of current on a 100-volt circuit, because just as much energy is wasted in the resistance as is used in the lamp. It will cost no more to run two lamps in series, and put them close together if only one frame is being exposed. The "enclosed" lamp (Fig. 66), is much used, and, indeed, has almost superseded the open arcs for printing purposes. Quicker exposures are obtained by means of "enclosed" arcs, because of the sensitive film being strongly affected by the violet rays which these lamps throw out.

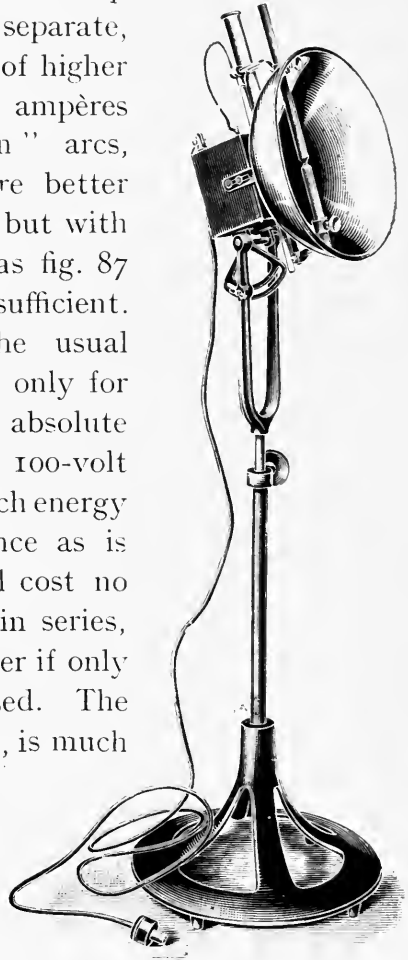

FIG. 90.

THE MERCURY VAPOUR LAMP.

Mercury vapour lamps have recently been introduced, consisting of a long glass tube in which some mercury is contained *in vacuo*, and when the current is switched on, and contact is made, the mercury is volatilised, and conducts the current so as to form an

arc, the whole tube being aglow with a greenish white light, which is perfectly steady, well diffused, and noiseless. Each tube only takes $3\frac{1}{2}$ ampères, which makes the consumption of current seem economical. Tests have, however, been made, which show that the longer exposures required make the current consumption equivalent to that of enclosed arcs, so that the advantages are not obvious. The tubes are liable to break down unaccountably, and altogether it must be admitted that these lamps have not proved a practical success. Further improvements may possibly make them so. They answer also very well for printing, but in this respect also they are not superior to the best enclosed arcs. We show a copying lamp (fig. 91).



FIG. 91.

LAMPS FOR COLOUR WORK.

Enclosed arcs were not at first found suitable for colour work, as the actinic violet rays were absorbed by the colour filter used. This difficulty has been got over by putting in the lamp carbons which are im-

pregnated by a material which gives a coloured light; for instance, a red light when using the red filter. The violet rays of the ordinary carbons do very well with the blue-violet screen, and are not very deficient with the green screen, though carbons that would give a green light would be an improvement.*

RESISTANCE COILS.

A word must be said about the resistance coils, which are in all cases necessary for cutting down the voltage of the supply. These should always be ordered with the lamps, as the vendor has no interest in supplying anything but that which is suitable for the purpose, and they will usually be sent out adjusted to suit the lamps. Although these resistances are made with an adjustment which permits more or less current being passed, it is not wise to tamper with them, as they may be very easily short circuited and burnt out. Any adjustment of the resistance should be done with an ammeter in circuit. The resistance coils generally used for arc lamp work consist of an alloyed wire wound round a porcelain cylinder. Such coils can be used either for continuous or for alternating current, but it is best in the latter case to use what are known as choking coils, which consist of a coil of insulated wire with an iron core, this latter being either a bundle of iron wire or of flat iron plates. Choking coils have the great advantage over ordinary resistance coils that they do not waste all the energy they "choke." An efficient coil may save as much as forty per cent. of the energy

* Mr. A. J. Newton, principal of the L. C. C. School of Photo-engraving, says that white flame carbons give more green rays than solid carbons, but all things considered thinks that solid carbons are best for enclosed lamps. See article in "Process Year Book" 1910-11, page 105.

which would be wasted in an ordinary resistance coil. "Economy" coils are still better, and transformers best of all, but are expensive.

Resistance coils, or choking coils, get hot whilst the current is passing, and the novice need not be alarmed at this unless he sees the wire red hot or the insulated wire of the choking coil smoking, as it is the function of these coils to dissipate electrical energy by transforming it into heat.

When changing from ordinary to coloured flame carbons it is desirable to have an adjustable resistance with radial switch having about six contacts, as the resistance is less with flame carbons, and more resistance must be put in the circuit to steady the arc. Some companies demand adjustable resistances, so as to switch on gradually.

The various details connected with the wiring need not be entered into here. They are best settled with the electrical contractor, but the writer cannot too strongly impress the necessity of sparing no pains nor reasonable expense to ensure a thoroughly reliable electrical installation, as upon this the whole success of a business will depend in the case of rapid commercial work.

CHAPTER VII.

THE ETCHING ROOM.

ALMOST any well-lighted and well-ventilated room will do for etching purposes, but if a room is being built for this express purpose it should, for preference, be on the ground, with the floor laid in concrete, having a "fall" to a drain at one side or in the middle, and in erecting the roof it should be given a ventilating ridge the whole length. It is not necessary to have the lighting from the top; it would be best to have a long lofty window, or several large windows, down each side. One end would receive the entrance, the other would be provided with a long sink. Down one side of the room under the window would be the fine etchers' and engravers' bench, unless these workers are provided with a separate room. On the other side the inking-up bench and powdering boxes. Near the inking-up bench, or on it, should be the hot plate, and it is good to have a flue over it to carry off the fumes. We have in the subsequent part of this chapter fully described the apparatus for the rolling-up process, though many think it obsolete. But in a half-tone establishment it is often necessary to do also some line work, and the glazed roller is frequently in requisition for fine etching half-tones. Down the middle of the room would be the etching tubs or etching machines.

With respect to the fitting up, there would be first of all in the corner near the door a brick ledge, covered with asphalt paving composition or slate, of about 6in. high, for the acid carboys and perchloride jars. Acid carboys should either be fitted with a syphon or, better still, the carboy in use should be provided with an iron stand (fig. 92). The carboy is fixed in the swinging basket, and anyone can pour from it without assistance and without danger of spilling.

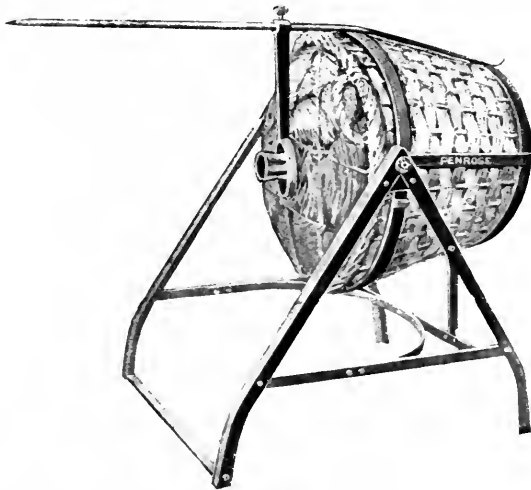

FIG. 92.

The sink should be roomy, and of a very substantial character. It is usually of wood, and heavily lined with lead. The joints should be "burned," not soldered. In many large etching rooms these sinks are about 6ft. \times 3ft., and perhaps 12in. to 18in. deep, but in a small room, where the plates handled are not more than 15 \times 12, a sink about 4ft. \times 2ft. 6in. is big enough. If economy is desired, a wooden sink pitched inside is the most readily made, and is really very

serviceable. A deep earthenware sink is the most durable and cleanly, but cannot be obtained in very large sizes. It may be fitted up as described for those in the dark rooms. Slate sinks have also been found very practicable.

Lead-lined sinks are soon eaten through, despite the idea that nitric acid does not attack lead. The drain pipe should, if possible, be of earthenware for the same reason. Enamelled earthenware tubes 2ft. long \times 2in. diameter are obtainable, and are excellent for draining acid sinks; and traps, bends, and connections can be obtained to match the same. The joints must be caulked with pitch.

At one end of the sink, covering about 2ft. of it, should be a grid of teak or oak, or of iron rod. This is for scrubbing the plates upon with potash, turps, etc. It will get such a greasy coating in use that there is little fear of the iron rusting or the wood rotting. A shelf should be provided at the side or back of the sink for the brushes, cans, and pots used for the cleaning operations, and a stove should be close to the sink to heat the plate, as this assists the cleaning. A stand pipe fitted with tap, rubber hose, and rose sprinkler, each, if possible, with separate connections, will form the water supply, and it should be fixed clear of the scrubbing grid, so that it will not be in the centre of the sink.

To rest the etching troughs on, the best thing is a strong wooden bench with a slate slab to form the top, as slate resists acid and chemical solution very well. The next best thing is teak wood.

ROCKING STAND.

If a large amount of continuous rocking has to be done, it is a good plan to have a mechanical rocking stand with a row of baths on it. Various methods will suggest themselves for obtaining the rocking motion.

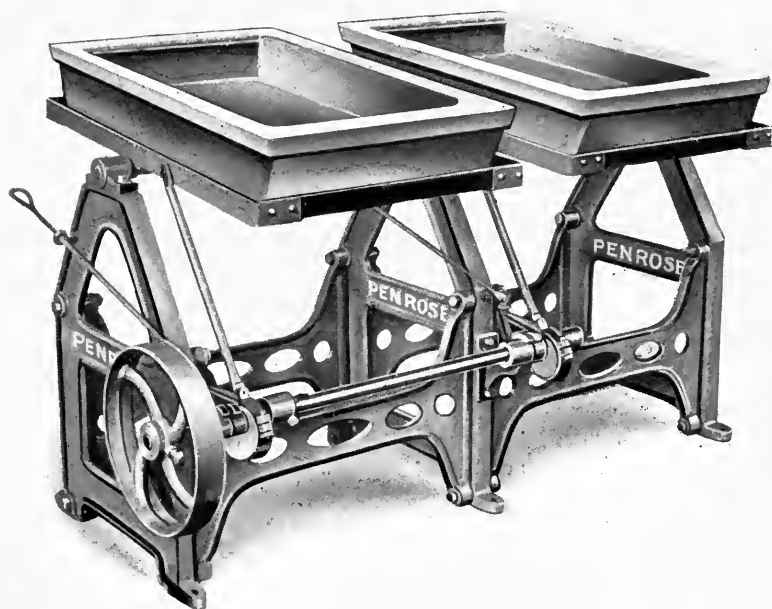

FIG. 93.

Where power can be obtained it may be done by means of an eccentric and connecting rod on the overhead shafting, or the eccentric may be placed on the driving axle of the stand or on the pivoting axle. Here is an illustration of a stand that may be taken as typical of such arrangements (fig. 93). The lever at the side enables the rocking motion to be stopped without stopping the motive power, the tub being thrown out of connection with the crank.

Etching machines have come largely into use of late years, and these are described in a subsequent chapter.

ETCHING TROUGHS.

For the etching troughs, trays, or tubs (as they are variously called), the rectangular wooden box with splashboard over each end is easy of construction, but is not satisfactory, as the vertical ends cause splashing. Sloping ends (as shown in fig. 94) are much better,

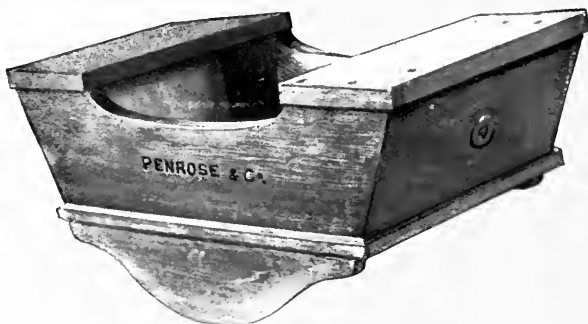

FIG. 94.

and give a more even wave. Wooden baths in any case must be coated with pitch or lined with sheet guttapercha well jointed. The lining with guttapercha



FIG. 95.

should be done by a manufacturer of rubber goods, but the pitching may be done at home, though my readers

will be well advised if they avoid the operation and buy a ready-made tub. Marine glue makes a good acid resisting coating, but it is difficult to apply, liable to run and form ridges when strong acid is used, as heat is generated. Pitch is also softened by the heating caused by the action of strong acid. "Mogul" varnish is a good resist for the purpose.

The baths that will last a lifetime, unless broken, are the earthenware or stoneware ones. There is one pattern, with ends sloped and turned over (fig. 95), which is very good and cheap. Another form is that of rectangular shape, with straight ends covered to prevent splashing (fig. 96). As these stoneware baths are heavy to lift

about for emptying, they are provided with a bunghole at the end. By having these baths on a stand, and a half-round earthen-

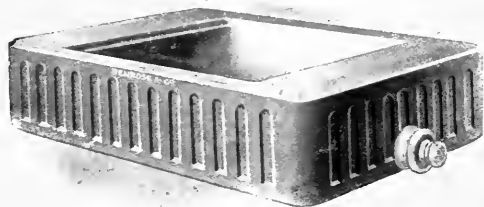

FIG. 96.

ware gutter arranged just under the bunghole, there will be no necessity ever to take them off the stand,



FIG. 97.

or to use buckets or other vessels, and there will be no risk, therefore, of breakage or spilling.

ETCHING TRAYS.

For etching with perchloride the same kind of stoneware troughs are used in many establishments, but as some think it is not necessary or desirable to rock the bath of perchloride of iron solution, shallower stoneware or porcelain trays (fig. 97) are used; in fact, the ordinary deep porcelain trays serve very well.

ETCHING CLAMP.

There is a great advantage in etching copper in a perchloride bath face downwards, and for this purpose a handy little wooden clamp is sold, which grips the plate by the edges, and prevents it touching the bottom (fig. 98). A simpler form can be had without the fixing bar.

HYDROMETER.

A very necessary accessory for the perchloride etcher is the Beaumé hydrometer (fig. 99). This is a glass float with a paper

scale inside, graduated from 0° at the top to 50° or more at the bottom. The solution is placed in a tall cylindrical glass jar, and on the hydrometer being placed in the solution therein it sinks to the degree on the scale, which denotes the density of the solution.

For filling the bath it is a good plan to have a vessel of known capacity. Heavy earthenware jugs (fig. 100) are best for the purpose. They are specially made for handling acid solutions. Although the general plan is to add acid by the eye and rule of thumb, the author strongly advocates measuring. Even though it need not be very exactly done, it is better than guesswork. It would be even better to work by hydrometer in the case of nitric acid etching in the same way as is done for perchloride etching. At any rate, it is easy

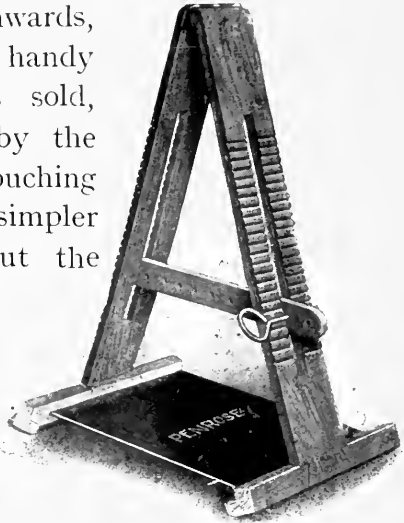

FIG. 98.



FIG. 99.

to have a vessel which shall represent 100 parts when filled, and a smaller vessel for the acid to be measured off in the same parts. By this means the acid may be added at a strength of so much per cent. without any troublesome calculation.



FIG. 100.

HOT PLATE.

For heating and drying the plates during the operations of etching, a stove in the form of a hot plate is required (fig. 101). For burning-in enamel plates and for heating after dragon's blood powdering, an open stove is requisite. (See fig. 78.)

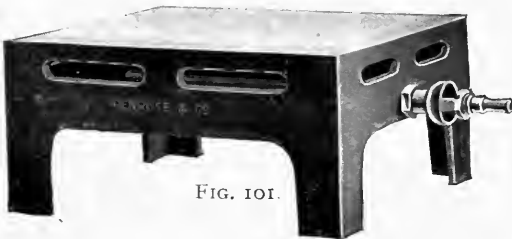

FIG. 101.

In some large studios a planed cast-iron plate, standing on a brick foundation, if possible, some-

what like a blacksmith's forge, is used. This may be constructed by taking a printer's iron imposing surface and standing it on a box of brickwork, with only a trap in front for lighting up the gas rings and a ventilating shaft behind. It must be borne in mind that to get uniformly diffused heat in such a plate there must be a deep turn-down rim round it in order to concentrate the heat. This may be done by bending around the plate a descending rim of sheet iron and

riveting the same on. Also remember that there must be ventilating holes on a level with the gas rings, or the burners will be put out by the absence of pure

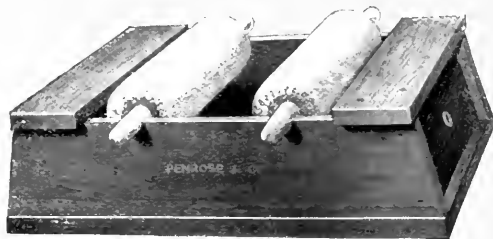

FIG. 102.

air. It is a good plan to have two or more rings, each with a separate tap, so that only a part of the plate may be heated if all is not required. Of late electric radiators have been adopted in some shops where the electric current can be obtained cheaply.

A sheet of asbestos board is a good thing to lay on the hot plate to modify the heat, and one or two pairs of large pliers should be hung up in a convenient place near the hot plate for handling the plates when hot. There are plate tongs (fig. 79) specially made for the purpose.

PLATE-COOLING TROUGH.

For cooling the plates rapidly the arrangement shown in fig. 102 is ingenious. The trough has two compartments one of which contains water (and ice in summer). One of the rollers dips in, and the top of the roller is out of the water. The back of the heated plate is passed to and fro over this roller two or three times until cooled. Then the plate is passed over the other roller to dry it. In the dragon's blood process, where there are many heating and cooling operations, this appliance is very handy. Another way of cooling the plates is to have a bellows for giving a cold blast of air. This

can also be used for blowing off the surplus resin, asphaltum, dragon's blood, etc., in powdering processes, and for drying off the gum coating in the rolling-up. An electric fan is the most modern improvement.

POWDERING BOX.

For powdering the plate with resin, bitumen, or dragon's blood, the powder may be in a shallow tray, or a box may be used with a grid about the middle of it on which to support the plate whilst brushing (fig. 103).

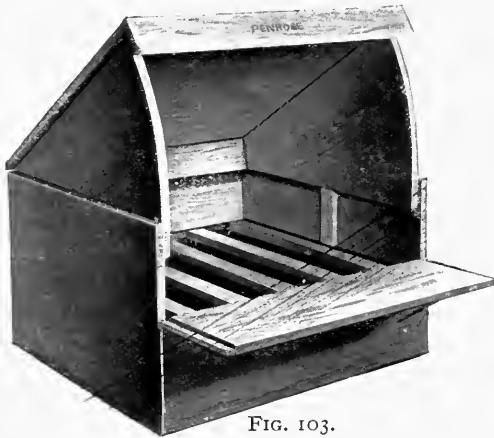

FIG. 103.

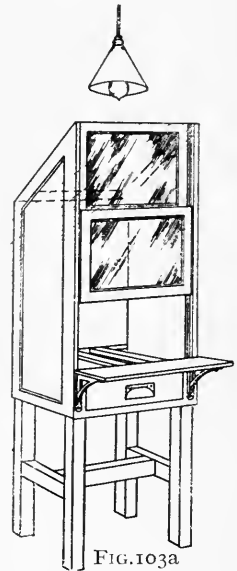

FIG. 103a

Where much powdering has to be done, it is better to construct a box about 6ft. high \times 3ft. wide \times about 2ft. from back to front, and have a sliding sash in the front of it (fig. 103a). On a level with the bottom of the sash inside, a tray is formed to the full area of the box. The powder lies loosely in this, and the brushes hang up on the walls of the box. When a plate has to be powdered the sash is run up, and when finished shut down, so that no powder can escape.

Sometimes a window at the side, top, or back is provided, and illuminated with an electric lamp.

In some studios the powders are kept in drawers under the bench, and these are drawn out as required.

The Levy etch powdering machine has superseded hand powdering in some of the largest shops, but its advantage is most appreciated in the line etching process.

POWDERING BRUSHES.

The nature of the brushes used for powdering is important. They are flat, very full of hair, and very soft. The hair appears to be a mixture of various kinds, evidently in order to get softness combined with the necessary springiness.

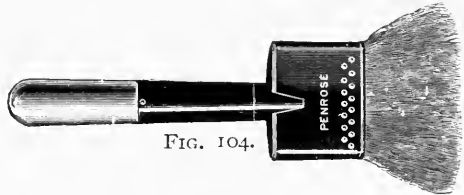

FIG. 104.

Sometimes the end of the brush is bevelled off at each side so as to suit the angle at which it is held in powdering. Fig. 104 shows the form of brush sold for this purpose.

ETCHING BRUSHES.

For nitric acid etching on zinc a soft bristle brush (fig. 105), flat, about $2\frac{1}{2}$ in. to 3 in. wide, is used, and the handle should be thickly varnished. The soft

hair brush, bound in with rubber (fig. 105a), is also good. There must be no metal in the mounting. These



FIG. 105.

brushes are used to clear the scum from the plate as soon as it is formed in etching.

Bear, badger, marten, or skunk hair seems to stand acids best, being of an oily nature. Camel-hair is soon rotted. A small round brush (fig. 106), bound with waxed string and shellac coated, known as "atzpinsel" in Germany and Austria, is to



FIG. 105a



FIG. 106.

be had cheaply, and is of marten fur. In default of this, a good quality of flat camel-hair dusting brush may be taken as a makeshift, and the handle thickly coated with shellac varnish.

ROLLING-UP BENCH.

The rolling-up bench should not be too high, or it will not be possible to get a good downward pressure on the roller. The top of the bench should be quite $1\frac{1}{2}$ in. thick, and well supported beneath, so that it does not spring when the roller is used to knock up ink on the slab. A few drawers underneath are useful for containing fresh supplies of rags, sponges, and sundries.

To fit up this bench for the rolling-up process, we require first of all near the hot plate a cooling slab, unless the wet cooling box is made use of as already described. One or the other may be dispensed with, but it is a convenience to have both. Sometimes the plate is bent in the heating, and it may be straightened by pressing it down against the cooling slab by means of the ends of the plate tongs, or with a pair of large bradawls. Iron is better than anything else

for cooling purposes, and the larger the slab the less chance there will be of its becoming warm by constantly laying upon it the hot zinc plates. A large lithographic stone is sometimes used as a substitute. In some large shops a press is used, which both flattens and cools the plate.

Next to the cooling slab will be the rolling-up stone, which will be an old lithographic stone of good size, with a sheet of indiarubber cloth on it to prevent the plate slipping about. Adjoining this will be an ink slab, this also being an old lithographic stone. At the back of this some sort of rack should be made for the rollers. Wooden brackets can be obtained for the purpose. A simple way, however, of standing lithographic rollers is to drill two or three holes in the bench large enough to put the handles through, so that the rollers stand on end.

ROLLERS.

The rollers will be at least two for each workman, one a "nap" leather roller, and the other a glazed one, both of the lithographic type (fig. 107). These rollers are formed of

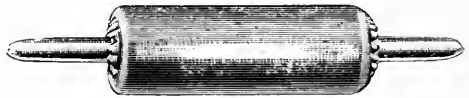

FIG. 107.

a solid cylindrical block of soft light wood, with handles of a harder wood, well driven and glued into the block. Sometimes, however, the block with its handles is turned out of the solid. The latter is first covered with flannel, over this is put calf-skin leather. In the case of the "nap" roller, the smooth or skin

side is placed inside, the "nap" having a more or less rough surface, which holds the ink.

To prepare a new roller for use it must first be rubbed with Russian tallow before a fire, heating the roller well and rubbing the fat in until it will absorb no more. Schmautz, the well known French roller



FIG. 107a.

maker, recommends for his rollers only rolling up in "middle" lithographic varnish until saturated, then with good black ink. Next apply some "strong" lithographic varnish, and knock up well on the slab until the varnish is evenly distributed on the roller. Now scrape the varnish off with a blunt knife held

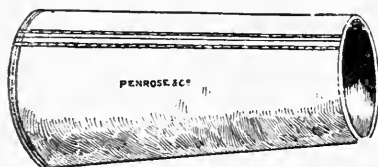

FIG. 107b.

nearly at right angles. If the knife seems to drag and ruffles the nap, it will show that the scraping is the wrong way of the grain. If the scraping goes smoothly,

mark the handle towards which the scraping is being done, and always scrape this way. After this varnishing, the roller is daily rolled up with lithographic ink, and scraped until ready for use. The roller should be put away with the ink on it, and scraped before being rolled up with fresh ink. A roller scraper (fig. 107a) is obtainable, and is better than a knife.

There is no satisfactory way of making a glazed roller quickly. The way usually described is to get a roller with the skin side outwards, and roll up in

an ink mixed with some hard and quick-drying ink and varnish. Red lead, gold size, and siccatives are used for the purpose. When perfectly dry, smooth down with glass paper, and repeat this process of rolling up and rubbing down until a smooth hard surface results. Simple as this method of preparing a glazed roller appears, it is hardly likely to be satisfactory enough to fit the roller for immediate use; because the skin side of the leather always shows wrinkles which cannot be completely filled up. Experienced etchers know well that the best glazed roller is an old lithographic colour roller which has become glazed and hardened by use.

Roller handles are formed of tapering tubes of leather (fig. 107b), which fit on to the handle of the roller, and so prevent the hands becoming sore through friction.

An indiarubber roller is favoured by some. It is also of the lithographic type, and should be smooth and hard. Handled rightly, it is capable of inking up the most delicate work quite as well as, or even better than, a "nap" roller, and it is also a good substitute for a glazed roller, if care be taken not to overheat the plate. A hard, well-seasoned composition roller on lithographic stock is also useful, especially for proving.

Of course, more slabs and more rollers will be required, according to the amount of work to be done and the number of hands working at the bench. It is advisable to have separate slabs for each kind of ink, and covers for them, so that a good deal of time

is saved which would otherwise be occupied in cleaning up and remixing inks. It is also good to have separate nap rollers for lithographic and etching inks.

INK KNIVES.

An ink knife for taking the ink out of the tin, a palette knife for mixing, and a push knife for scraping the slab are requisites ; and a little bridge of wood should be nailed to the bench to rest the blades on when covered with ink, so that they will not daub the bench. These knives have already been illustrated in preceding pages (figs. 82, 83, and 84).

Two basins and sponges should be provided near each ink slab, one for water and the other for gum solution. Damping rags of meat cloth or cheese cloth are also required.

HAND-REST.

For retouching the plates before or in the course of etching a hand-rest is useful. This is simply a strip of thin wood, say 3in. \times 18in., with a batten at each end underneath, so that it bridges over the plate without touching the surface (fig. 108).

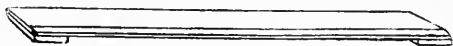

FIG. 108.

ETCHING TOOLS AND SUNDRIES.

Each etcher is usually provided with a fine sable brush, and a square steel point set in a cedar handle like a lead pencil, which he calls a "scratcher." A smaller and sharper tool, known as an "etcher's point," is also used for removing spots between the dots. These tools are of the same form as fig. 110. With these tools he does all his clearing up and

retouching. For line work and vignettes a slip of snakestone is also useful to make any large erasures. Sticks of artificial pumice stone are also to be had for erasing purposes, and are very good.

Near the stove is usually placed a shelf, so arranged that the plates can be leaned against the wall, and the back and margins painted with a resist varnish, generally of shellac, applied with a camel-hair mop.



FIG. 109.

The fine etcher's bench, which of late years has become of much

greater importance than the rolling-up bench, is provided with sloping desks to support the plate, and each man should have a little easel to support the original picture in front of him. Some firms put all originals into a frame with glass in front, so that they do not get injured by unclean hands.

A good assortment of fine sable or Chinese brushes and saucers for ink and stopping-out varnish are requisite. Also a stiff plate brush (fig. 109) to clean out any grit from between the dots.

Etching needles, burnishers, roulettes, and graters are also used by the fine etcher, if, as is frequently the case, he combines the duties of fine etcher and engraver-retoucher.

ETCHING POINTS.

Etching needles are square, lozenge, round, and oval steel points set in wooden handles, presenting the appearance shown in fig. 110. The fine points are

used for taking out any black spots between the dots, and for scratching white lines as guides for borders. The square, lozenge, and oval points are used for scraping in vignetting operations.



FIG. 110



FIG. 111.

BURNISHERS.

Burnishers are made in a great variety of shapes, either all of steel, as fig. 111, or with wooden handles, as fig. 112. The steel blade is highly burnished, and, of course, must be carefully protected from rust.



FIG. 112.

They should be wrapped up in washleather when out of use. When a light part of the half-tone grain is rubbed with a burnisher it prints darker, and thus any over-etching or want of contrast can be remedied.

ROULETTES.

Roulettes (fig. 113) have the opposite property to the burnishers. They lighten any parts which would print too dark by stippling the places required with fine holes, which print as white dots. There are a great variety of roulettes made, some only with one row of dots, like a spur, and others with a number of rows. They are also in varying degrees of fineness corresponding

to the grades of the half-tone screen. Roulettes are also made with lines instead of dots on them, the edge of the wheel being "milled" like the edge of



FIG. 113.

a coin. These are mostly used for breaking up heavy line work, but they can also be used to advantage in half-tone vignetting to run round the edge and soften the work.

GRAVERS.

A great variety of gravers (fig. 114) are used where the plates are elaborately retouched by the engraver. These gravers are much the same as used by wood engravers, but are of a different temper, and set to a different angle. Rubin, of Paris, makes the finest gravers in the world. Vautier, a Swiss maker, runs him very close in reputation. There are also gravers of Sheffield manufacture, which are very good. A peculiar class of gravers which are much used by process men are known as "many liners" (fig. 114a).

They are, as their name implies, gravers which cut many lines at one operation, having a serrated cutting edge. They are very useful in vignetting to break up the

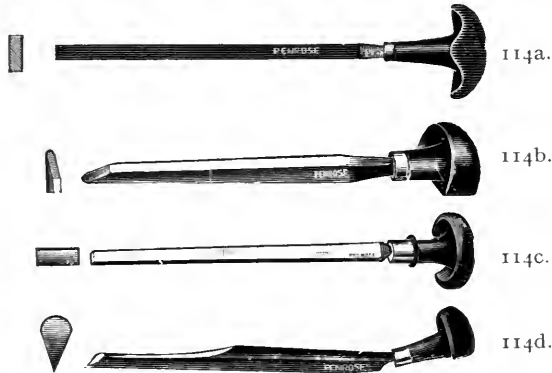

FIG. 114.

hard edge of the work which would otherwise print very heavy. For removing large white spaces or for cutting round the edges of vignettes or "cut-out" blocks, "scorpers" which have a half-round back are used (fig. 114b). Flat chisel-like gravers are also used (fig. 114c). For opening up the spaces between dots the tint graver (fig. 114d) is effective.

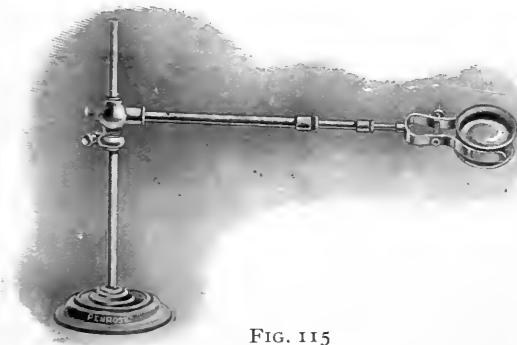

FIG. 115

ENGRAVER'S MAGNIFYING GLASS.

The fine etchers and engravers require hand magnifiers to be able to see their work, and it is

very convenient to have the magnifiers supported on a stand with swinging telescopic arm, as fig. 115.

ILLUMINATING LENS.

When working by artificial light, a water globe or a bull's-eye lens (figs. 116 and 117) must be provided to focus the light of the lamp on to the plate.

RULING BOARD.

The ruling of the border lines, and the writing or engraving of the imprint name in the corner of the plate, are usually done on the fine etcher's bench.

A useful appliance for aiding the ruling of the border lines is the ruling board (fig. 118).

This is a well-clamped board with a raised strip of brass on two sides of the board, thus forming a right angle, in which the plate lies and is held by a clamp which runs in the diagonal slot.

A T square with an adjustable head is used in connection with this board. If the picture is not quite parallel on the plate, the T square is set to any perpendicular object on it. The head of the square being screwed up and pushed against the outside edge of the right angle brass strip in which the plate

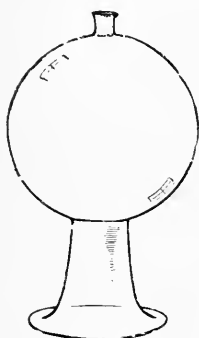

FIG. 116.



FIG. 117.

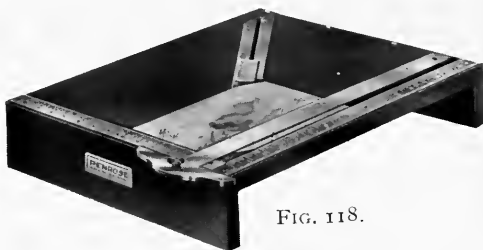

FIG. 118.

is held, it is obvious that the T square must rule parallel lines at top and bottom and each side of the picture, forming perfectly right-angled corners, without



FIG. 118a.

the necessity of measuring or trying with a set square. A similar arrangement is used for ruling up negatives and cutting the film for stripping, but in this case the bed

is formed of a sheet of ground-glass, and there is a white reflector behind (fig. 118a).

If the ruling board is not used, a right-angled steel set square, L shape, with both sides of equal thickness, is used, one line being struck and the others successively ruled from it. Set squares of 45° of steel, ebonite, or transparent celluloid are also used for the purpose.

ELLIPTOGRAPH.

For ruling circles or elliptical border lines, either brass shapes are used as guides for the ruling pen, or

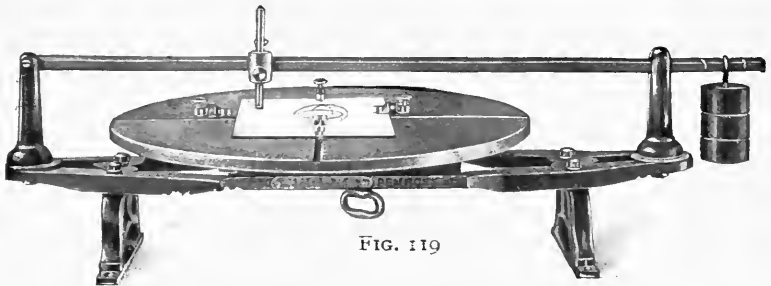

FIG. 119

an elliptograph (fig. 119) is employed. The latter is a highly ingenious and useful little machine, which

will rule any size of circle or oval most perfectly. It is provided with a ruling pen for ink, and a graver to cut white lines. Most of the large photo-engraving houses have these machines, which soon repay their cost where there is any considerable amount of work.

LETTERING GAUGES.

To ensure neatness in lettering the name, line gauges are used (fig. 120). These are small blades of steel,



FIG. 120.

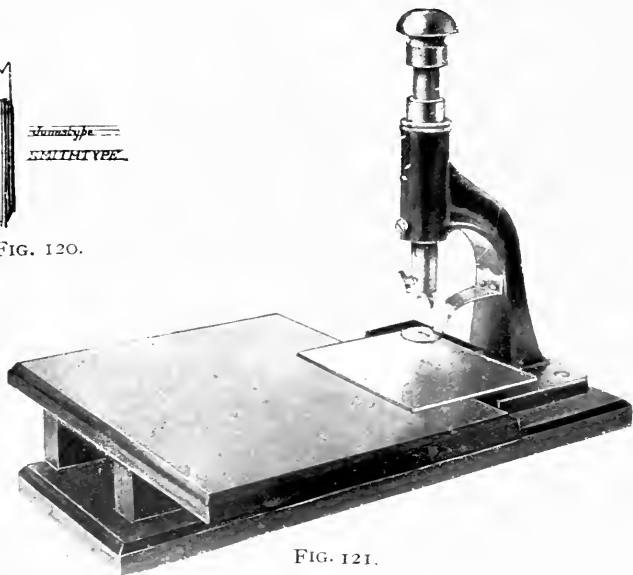

FIG. 121.

something like a short length of watch spring, notched at the end to form two or three points, as the case may require, and these blades are set in brass holders about the length and thickness of a retouching brush. When these gauges are run along a straight edge, they make two or three fine parallel scratches on the surface ruled upon. Lettering drawn upon these lines can be made with the letters of even height. A three-line

gauge is useful for capitals and small letters, and a two-line gauge for capitals only. There are a dozen different gauges in a set of each kind. The best way, however, of lettering a block is to use a stamping press, as fig. 121. The name is cut on a steel die, and inserted in the plunger, which is adjusted to stamp only to the requisite depth, or it may make a mark only sufficient to guide the pen and brush in making black lettering.

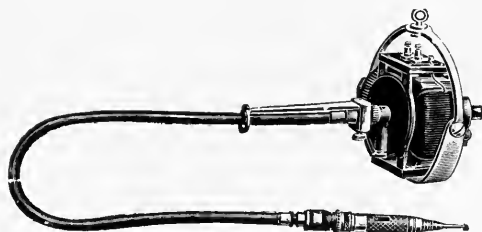

FIG. 121a.

In some of the large establishments an engraver's ruling machine has been added to the equipment of the fine etching and engraving department. By its means skies and backgrounds can be cut in perfectly parallel and regular lines across the half-tone grain, so that the plate prints lighter in these portions.

ELECTRIC PEN.

For outlining the vignetting preliminary to routing some firms use a dental drill, which consists of a flexible shaft driven by a small motor, and carrying at the end a rose-shaped "bit" in a holder something like a fountain pen (fig. 121a). A channel is scraped away, rendering the course of the vignetting easy to follow with the routing machine.

LITHOGRAPHIC PRESS.

If there is space to spare, it is desirable to have a press in the etching room for taking proofs from the plates when operations are completed. It is much better that the etcher should be able to see the effect of his work as soon as etched, so that any faults may

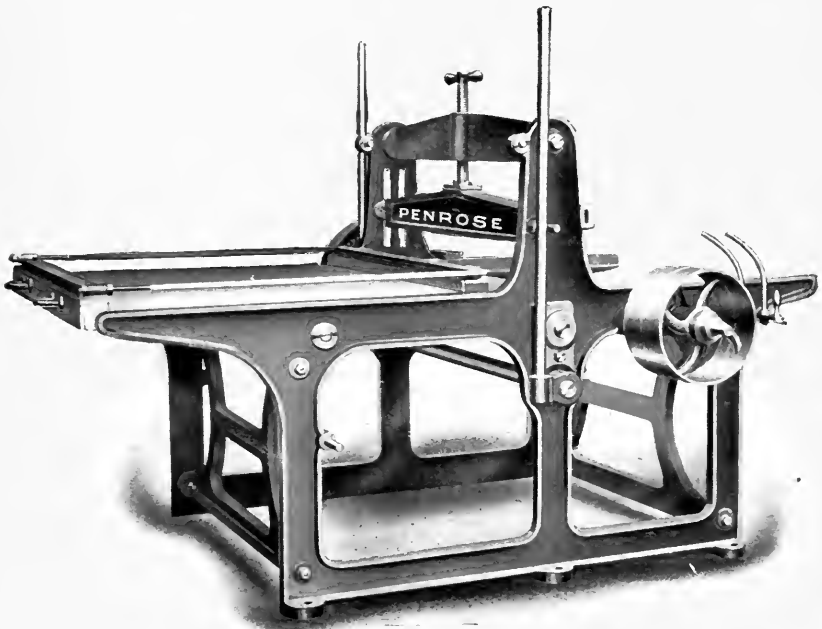

FIG. 122.

be remedied before it leaves his hands. A lithographic press (fig. 122) will do very well for taking proofs from plates, and as it is much cheaper than a type press, it may, on the whole, be recommended. On the Continent a smaller roller press, something like a copper-plate printing press, is much used (fig. 122a).

BENCH LINER.

Royle's have recently introduced a very useful appliance called the bench liner (fig. 123), for the purpose of making the ruled lines round the edges of

the plates. This consists of an iron bed with a rod down one side. On this rod, which acts as a guide, there is a swinging

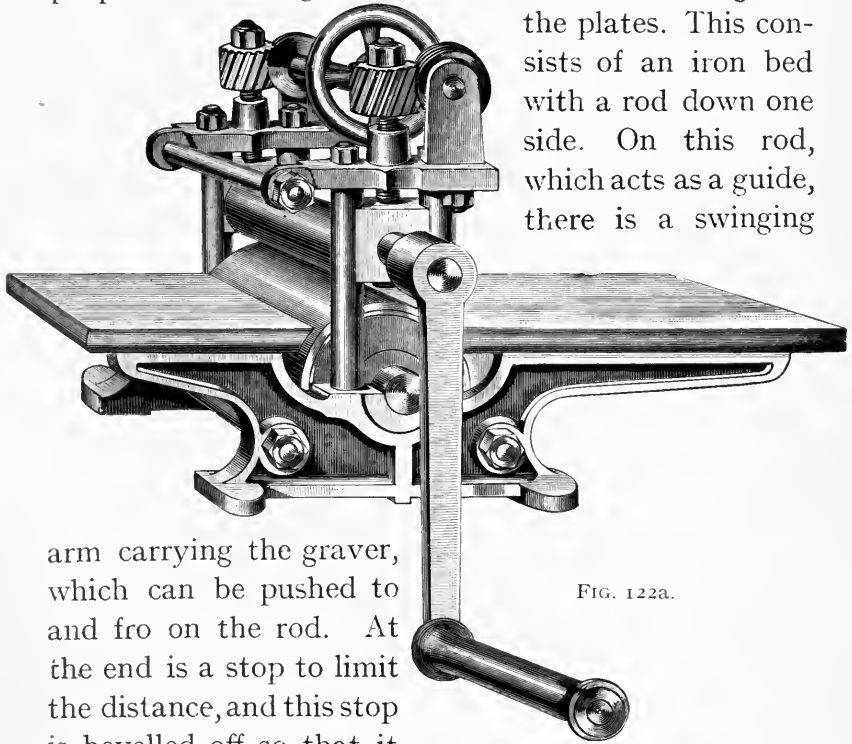

FIG. 122a.

arm carrying the graver, which can be pushed to and fro on the rod. At the end is a stop to limit the distance, and this stop is bevelled off so that it

automatically forms a mitred corner when several rules are put round the block. The toolholder is provided with a feed motion and micrometer for spacing out the lines.

Penrose and Co. have recently introduced a somewhat similar machine for squaring up colour plates, ensuring the edges of the plates being in register (fig. 123a). Another pattern is made also to rule lines round the plates before they are trimmed up.

Respecting the arrangements for lighting, a long window or row of windows will furnish a good light by day, and a gas bracket with universal joint, and



FIG. 123.

a shade over each etching trough, each rolling-up slab, and each fine etcher's or engraver's desk, will be requisite. If the luxury of incandescent electric light

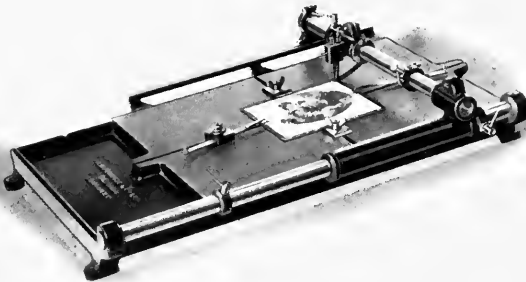

FIG. 123a.

is provided, as may readily be done where there is an electrical installation for the studio, so much the better. The windows should not be made to open at the bottom, as this may drive in a lot of dust on the

ink slabs and on work in hand. The hot plate will probably provide all the warmth required in the winter time, and it will be best if it can be made to do so, as a coal or coke stove will certainly generate dust, the arch enemy of the half-tone process, unless it is one of the closed stoves which burn anthracite. The hot plate may be supplemented by a gas-heating stove if necessary.

CHAPTER VIII.

THE MOUNTING.

THE author feels some difficulty in giving instructions for the equipment of the mounting room, because circumstances will determine whether the

mounting will be done entirely by hand work or by means of power machinery.

In a small establishment where there is not much work and no necessity for "rush," a treadle circular saw, a jig saw, and a shoot and bevel plane outfit will be all the machinery required, though it may be supplemented with advantage by a guillotine, which will presently be described.

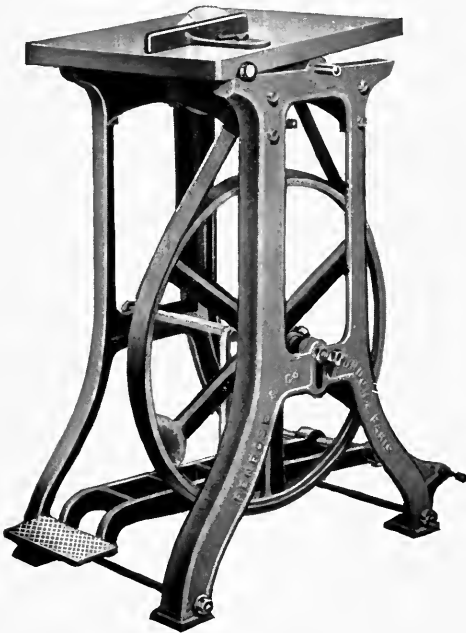

FIG. 124.

CIRCULAR SAWS.

The treadle saw will be of such a pattern as fig. 124, and it will serve for cutting up zinc and copper and mounting wood. Separate saws for metal and wood

are desirable. The difference between the two saws is that the wood saw has fewer and larger teeth, and is of larger diameter, than the metal saw, the teeth being also "set" rather strongly to give clearance for the blade. The metal saw is generally of a thicker gauge, smaller diameter, less "set," and more teeth

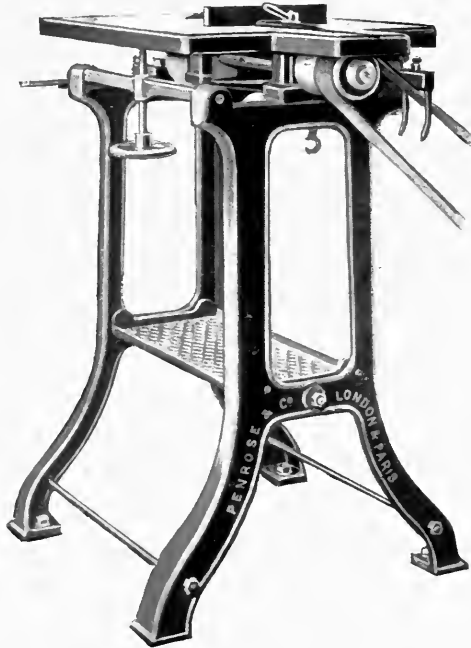

FIG. 125.

(therefore finer teeth). A wood saw will probably have not more than four to six teeth to the inch of circumference, whilst a metal saw will have eight to ten. The smaller the diameter and the finer the teeth in a metal saw the better. The circular saw is not only used for straight sawing, but a good deal of trimming may be done on it in the case of vignettted or shaped blocks.

Wherever power is available it is far better to have the circular saw run by power. (Figs. 125 and 126 show well known patterns.)

JIG SAWS.

For cutting out spaces in the interior of a picture the jig saw (figs. 127 or 127a) is used, as well as for

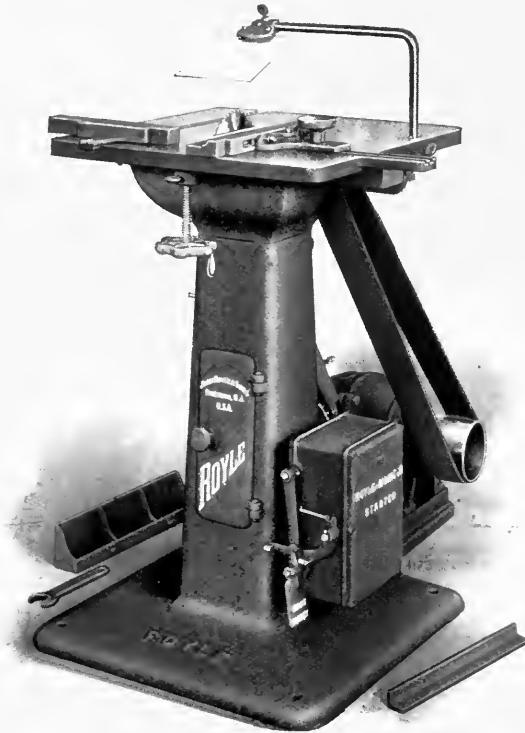

FIG. 126

difficult places—round, shaped, and vignettted blocks. The jig saw is, however, a machine which is least needed, as the author has already pointed out that the circular saw will do a great part of its work, whilst a hand fret saw will do the interior spaces, or, better still, the routing machine where available.

Royle's make a very good jig saw for power (fig. 128), either with or without drill. A bevelled iron block is provided for drilling on, so that the nail or screw holes can be made on the bevel of the plate.

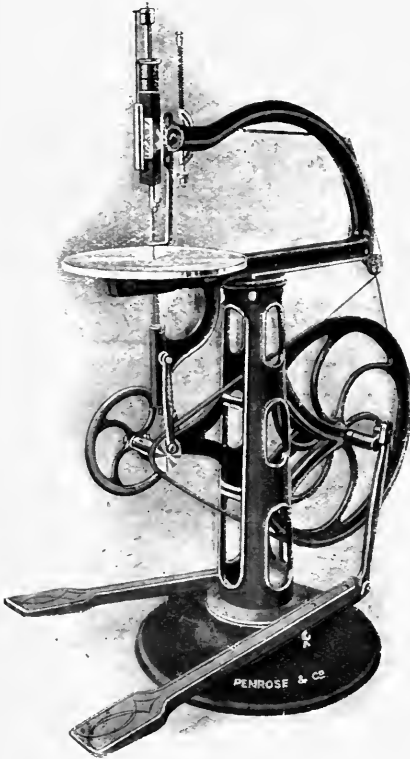

FIG. 127.



FIG. 127a.

SHOOT PLANE.

The shoot plane is an indispensable tool in small establishments where a beveller and trimmer is not warranted. Fig. 129 shows the usual form. It consists of an iron bed-plate with a channel at the side, in which an iron plane works to and fro. One plane

is provided for trimming the edges of the wood blocks, and the other for bevelling the edges of the plates, so as to permit the nail heads to lie below the surface.

It is really very important to make a good bevel on

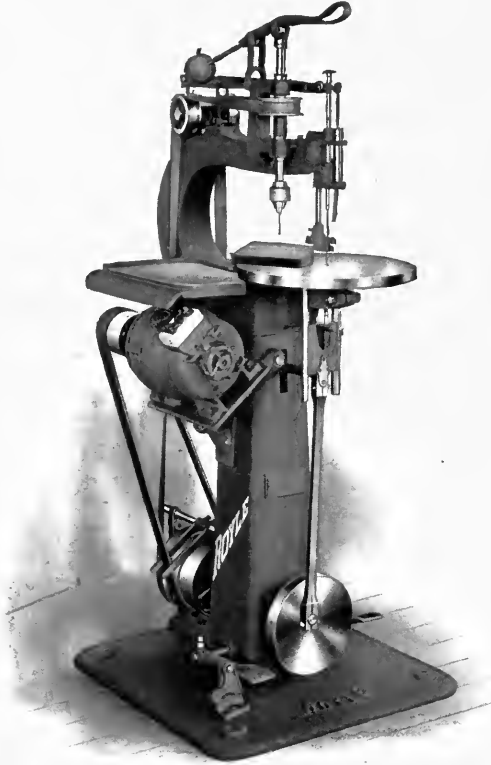

FIG. 128.

the plate. A half-tone block which prints with a smeared outline and with several nail heads showing up is probably a good block spoiled by bad mounting. Many attempts have been made to dispense with the rebate, by filing or cutting the edge flush and by gluing the plate on to the wood, and by soldering

small brass screws on to the back of the plate ; but the best and neatest way, after all, is to cut a bevelled rebate. This can only be done by use of a suitable plane. The requirement in such a plane is plenty of weight, and for this reason, and also because of the wear and tear, it is generally made of cast-iron, with a planed face, in which a narrow groove is cut, corresponding to the rebate, and with its under side level

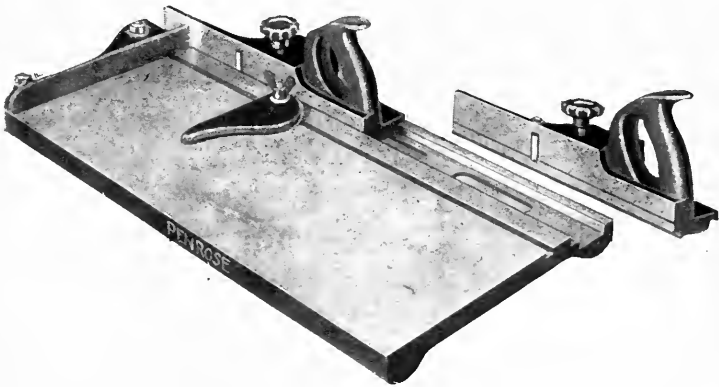

FIG. 129.

with the top of the board. The cutting iron is set in this groove, and as the cut is made, the tongue of the rebate gradually passes under the cutter into the groove. The cutter is sharpened on the side as well as the end, and the angle of grinding is very important, and can only be found by actual practice. A second plane is usually supplied for squaring the wood mounts.

BLOCKING AND CHIPPING PLATES.

Whether the mounting room is provided with power machinery or not, a good bench must be provided for

the "blocking," and this should be well lighted by windows, and by gas brackets or electric lamps at night. On this bench the shoot plane outfit will be placed, and in another part the blocking plate (fig. 130). This is an iron block about 1 in. thick, provided with a stop at one end to keep one side of the plate square on the wood mount whilst being nailed on, the base giving the necessary solidity when hammering and punching in the nails.



FIG. 130.

A similar block made of lead, called the "chipping block" (fig. 131), is used in addition to, or sometimes

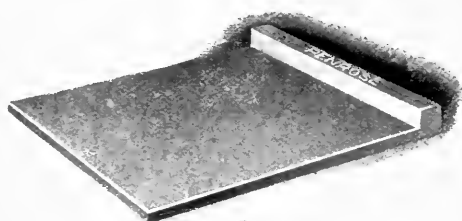

FIG. 131

instead of, the above, for chipping away the edges or white parts of the plate in establishments where there is no routing machine, and also for punching

the nail holes in the zinc plates with a sharp punch, this method being quicker than drilling if the plates are thin. It is well to have a hand drill also, in order to countersink the holes, though a power drill is better. The lead block serves for hammering on when driving in the nails. Chipping tools (figs. 131a and 131b) are enlarged engraving tools, but are either provided with a handle like a carpenter's chisel, and are to be used with a mallet, or have a solid shank, and are used with a broad, flat-ended hammer.

PUNCHES.

Three punches are required. One is sharp and highly tempered for punching the holes (fig. 132); one with a flat end about one-sixteenth of an inch diameter, for



FIG. 131a.



FIG. 131b.

driving home the nails (fig. 132a); and one with a broader head, about one-eighth of an inch, which is termed a flattening punch (fig. 133). Another useful form of



FIG. 132.

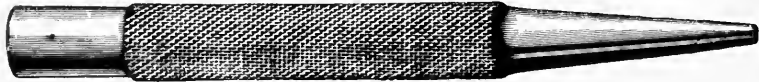

FIG. 132a.

punch is one with a rectangular end about $\frac{1}{16}$ in. \times $\frac{1}{8}$ in., this being used for straightening out a bevel if bent during the nailing on the block, or through having to remove the plate and replace it (fig. 133).

There is always a risk when driving a nail that the punch may slip and damage the work, and Penrose and Co. have introduced a neat little tool (fig. 134) for overcoming this difficulty. It is a hollow tube with

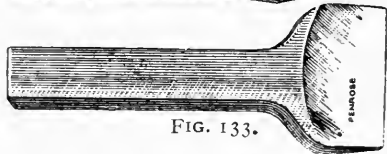

FIG. 133.

punch inside. The tube is slipped over the nail, the punch acting as a plunger being driven with a hammer.

HAMMERS.

Three hammers, of 4 oz., 8 oz., and 16 oz. weight of head, will be necessary--the first a carpenter's hammer and the last two engineers' hammers. A light mallet is required for use with the chisels.

A nailing machine has recently been introduced from America. This drills a hole and then drives a nail in. It is good where a large amount of rush work is done.



FIG. 134.

SUNDRY TOOLS.

It is sometimes necessary, for the purpose of underlaying, to lift the plate from the mount after it has been nailed down. There is a danger of damaging or bending the plate by using ordinary tools, but a pair of wedge-shaped tools have been introduced Mr. Arthur Cox, for inserting under the plate and lifting the nails.

A 36in. steel straight-edge, a good steel or boxwood rule, a carpenter's square, a steel try square, a pair of steel dividers, and one or two metal files are among the requisites. A dozen assorted engraver's scorpers are useful for removing burrs on nail holes, bevels, and routed edges.

GUILLOTINE.

It will be the duty of the mounter, as a rule, to cut up the metal for the etchers, and this may be done on the circular saw, or by means of the guillotine (fig. 135). The circular saw has the advantage that a corner can be cut out of a large plate, whilst the

guillotine must cut through the whole width.* However, the guillotine makes a clean cut, whilst the saw cut has to be filed. By cutting up to sizes found by experience to be most useful, the guillotine can be utilised to the best advantage.



FIG. 135

MOUNTING WOOD.

Mounting wood can be bought ready planed to the exact gauge, so that it is no use bothering oneself with planes and boards for backing the blocks. In a large establishment, as we shall presently show, it is profitable to have a rotary planing machine. A hand saw for cross-cutting long planks of mounting wood to suitable lengths is necessary.

* Penrose and Co. have recently introduced a guillotine which will notch out pieces from the corners of a plate as well as make straight cuts.

ZINC HOOK.

Workers in a small way may cut up zinc with a tool known as a zinc hook (fig. 136). A deep score,



FIG. 136.

guided by a straight edge, is made in the zinc, which is then snapped against the edge of the bench. A zinc cutting board with permanent straight-edge can be obtained in the form illustrated (fig. 137).

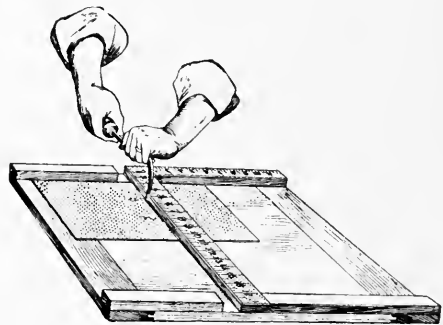

FIG. 137.

MACHINERY.

Turning now to the question of power machinery, which has become one of the most important considerations in the successful running of commercial establishments, the choice of a suitable location must be first dealt with.

The mounting is often associated with the etching room in small establishments, but this is not to be advised, as the sawdust and chips of zinc and copper get into the ink or the dusting powders, or are embedded in the rollers, causing trouble. Apart from this, the noise of the machinery, if a full line of machines is run by power, is distracting to the etchers, whilst the vibration makes it difficult for the fine etchers and retouching engravers to do delicate work.

If it is not possible to have a separate room, a place, at least, ought to be partitioned off from the

etching room, and, if power machinery is run, it should be as far away as possible from the studio, owing to the vibration caused.

Plenty of daylight is required for the manipulation of the machines, especially the router and the beveller. Electric lamps are also generally fitted on or above the machines.

The floor should be a very solid one, and if a ground floor is used it is much better to put down a cement foundation, if it does not already exist. The machines will work quite well on upper floors, but the vibration will cause the cutting to be not so smooth, and the cutters will be blunted sooner, besides the machines wearing more rapidly.

A good ceiling for fixing countershafting is an advantage; but it is, as a rule, possible to fix it to the floor, if space permits, or to the wall.

Where the luxury of a separate electric motor for each machine can be afforded, all countershafting is dispensed with, and the machines can be placed anywhere that suits best. There is no doubt that this is the ideal way of driving the machinery.

The power for driving machinery is invariably the electric motor, unless power shafting is already running in the place. Even then it is generally an advantage to have a motor, as this renders the photo-engraving department independent, and able to run when the rest of the establishment is shut down. About 2 h.p. to 3 h.p. will run all the machines likely to be required in a photo-engraving establishment, and each separate machine can be run by a motor of from $\frac{1}{2}$ h.p. to 1 h.p.

It is becoming quite a common practice now to have an independent motor for each machine.

Continuous current motors are the most satisfactory wherever this current can be obtained, as they will

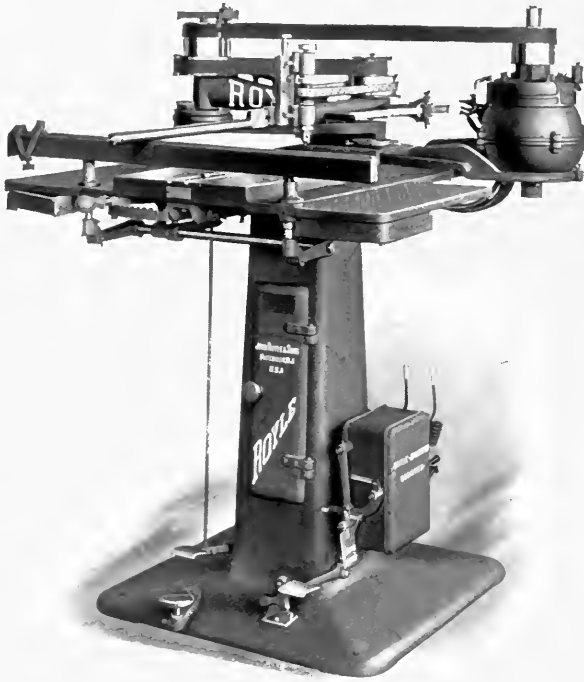

FIG. 138.

stand a temporary overload better than alternating current motors and will start better under load.

All the machines being run at a comparatively high speed, the shafting should be light and free running, with good lubrication, well-balanced pulleys, and very flexible belting with neatly-made joints.

ROUTERS.

The most important machine is the router, the purpose of which is to rout or hollow out portions of the plate which are to be left white in the finished proof. This is requisite in vignetted and shaped blocks, and especially in blocks for catalogue illustration.

The router (fig. 138) is made in a variety of forms, but one principle is common to all, viz., that a drill-like cutter is revolved at a high rate of speed whilst in contact with the plates, cutting out the metal in circles running one into the other as the cutter or the work is moved about. The machines may be divided into two classes: (a) Those in which the revolving cutter is in a stationary position and (b) those in which the cutter is moved about on an arm having a radial movement, much in the same way as the movement of the pencil or tracer in a pantograph. Machines of the former class are usually of a limited size, and are used in small establishments, whilst those of the last-named class are used by large firms for handling all kinds of work.

The excellence of the machine chiefly lies in the perfect finish and fitting of the head containing the bearing of the revolving spindle. When it is mentioned that this spindle has to be run at a speed of 14,000 to 20,000 revolutions per minute, the perfection of the mechanical fitting requisite can be judged.

Royle and Sons, of Paterson, N.J., make the finest and greatest variety of routers, and their machines are recognised as the standard type all over the world.

European makers have not been successful in the

manufacture of satisfactory routing machines for photo-engravers. The Royle radial arm router is probably the most popular and extensively used throughout the trade.

These machines, to be at all satisfactory, must be run by power. Treadle routing machines have been made, but have never become popular in the photo-engraving trade. It is true that brass plate engravers use treadle routing machines extensively ; but it must



FIG. 139.

be remembered that brass is an easier metal to cut than zinc or copper with properly adjusted tools, and the work is fed up to the cutter by means of a screw motion. Special attention is also given to the shape of the cutter and its sharpening. Moreover, it is said that it takes at least a year to train a youth to work a brass engraver's router with any degree of satisfaction.

The author's opinion is that if power cannot be obtained to run a router, it is better not to use the router at all, relying on the etching bath and the chipping chisels to deepen the work. The forms of cutters

used in routing machines are shown here with (fig. 139).

“C” is flat and is used for cutting soft brass and sometimes for zinc. “E” for copper is fluted. There are also “A” cutters for wood, soft metal, zinc, &c., “B” for hard zinc, and “D” for hard brass. The cutters are only ground on the ends to sharpen. A handle (fig. 139a) is used to hold them against the grindstone. They are finally finished with a rub on the oilstone. The shape of the cutter must not be altered, and those who attempt to sharpen a cutter should compare it with a new one.



FIG. 139a.

BEVELLERS.

In the majority of photo-engraving houses a rotary beveller (fig. 140) is used. Where a considerable amount of work has to be done, it is a very useful appliance. The plate is clamped to a bed and fed to a guide until the revolving cutter, which is like a lathe chuck, with two or more tools set on its circumference, is opposite the part to be bevelled. The bed is then pushed forward under the cutter, and a furrow is made. It will be seen that it is not necessary to trim and square the plate first, and the waste margin can be left on until the proof is pulled, acting as a bearer against the tendency of the impression to be too strong at the edges of the picture. Afterwards the margins can be snapped off by bending with the fingers or with a pair of pliers.

LINING BEVELLER.

Recently the beveller has been elaborated by the addition of attachments for making the black and white border lines round the plates. Hitherto these



FIG. 140.

lines have been put on by scratching through the negative film, or ruling with "resist" ink on the plate before etching, or by scratching or engraving the lines on the plate before or after etching. The lining beveller (fig. 141) performs these operations on the



EXAMPLE OF WORK
DONE ON ROYLE'S
LINING BEVELLER.



EXAMPLES OF WORK
DONE ON ROYLE'S
LINING BEVELLER.

plate even after etching, if the machine is of the type known as the "raised line" beveller. The way in which the machine makes a black line on an etched plate is very ingenious, although it is a method long practised with hand tools by electrotypers. A small cutter called a "lance" is used, and its object is to cut a line with a very heavy burr thrown up at the sides. This burr is then shaved off with a chisel-shaped graver to the level of the printing surface, and the result is a black line. If a white line is desired inside the black line, a chisel which has a

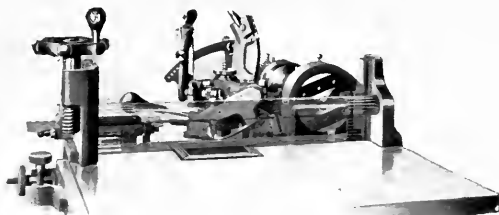

FIG. 141.

projecting graver edge to it is used, and makes a cut alongside the black line. If more than one white line is desired, the tool can be stepped forward, or the table can be moved to and fro by means of a micrometer adjustment. Some of the machines carry two or three gravers of different patterns on a revolving head, so that they may be brought into position successively, and avoid changing tools.

TRIMMERS.

Another labour-saving machine is a trimmer (fig. 142). It may be simply described as a rotary shoot plane, its object being to trim the ends of the wood

mounts quite smooth and square, after they have been roughly sawn off. The block is placed on a sliding table, and pushed past the cutter head, which is provided with two or more cutters, and revolves at a speed of about 4,000 per minute. In using this machine there is a tendency, unless the knives are



FIG. 142.

well set, to “jag” the under edge of the wood. This can be avoided by placing under the block a thin sheet of lead, and taking a cut off that at the same time.

A form of trimmer much used in England is that shown in fig. 143, and popularly known as the “Bowler,” and is more easy to manage than the American trimmer.

ROTARY PLANER.

Although mounting wood can be bought ready planed to gauge, it is found an economy in large establishments to have a planing machine (figs. 144 and 145), and prepare the wood on the premises.



FIG. 143.

The planing machine is in the form of a horizontal disc, with two cutters set in its underside, and the wood is clamped to a travelling bed, which automatically passes under a cutter disc. The practice usually adopted is to plane up short lengths from 18in.

to 2ft., somewhat above the proper height. The moulder pins his plate on to a corner of one of these lengths, saws off the piece close to the plate, and puts the block on the bed of the planer with the engraving face downwards. The cutters are set by means of an adjusting screw to plane exactly type height, and the block

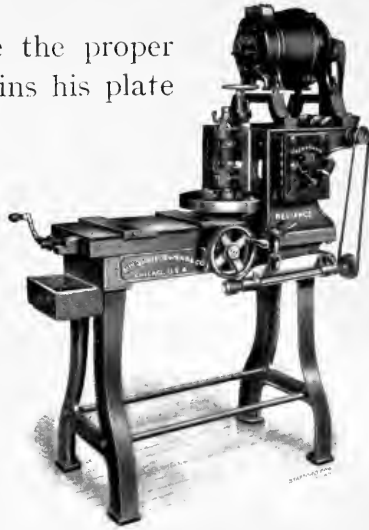

FIG. 144.

is therefore sure to be accurate and parallel. A machine specially adjusted to back down the blocks to exact height after mounting has been introduced called the "type high planer." A handy little bench machine for the same purpose is the "Rotary Cut Sur-

facer." Where a rotary planer is not available, a handy appliance for levelling up the backs of blocks after mounting is the backing plane (fig. 146).

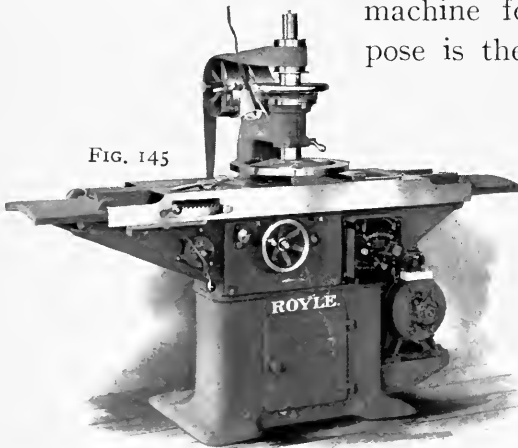

FIG. 145

VIGNETTING MACHINE.

A useful little machine that has come into vogue of late is Moles's vignetter (fig. 147). It consists of a milling cutter running very much like a circular saw, and just projecting through the table, so that it cuts the underside of a plate passed over it. In this way the edge of the plate is thinned down, so that when mounted and hammered down with a rawhide or rubber mallet it is bent over, and therefore does not receive so much impression as the centre of the plate.

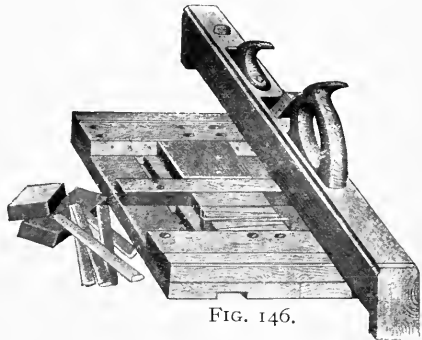

FIG. 146.

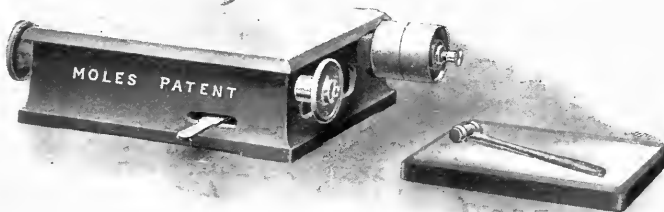

FIG. 147.

The foregoing comprise all the machines that can be usefully employed by the photo-engraver. Sometimes a power-drilling machine is used in large establishments, and the circular saw is often duplicated, so as to keep one machine for metal and the other for wood. Two different types of routers or bevellers may be used where there is a large volume of work, but in general

one or two good mounters can keep pace with half-a-dozen or more operators and etchers.

A type-high gauge is a very useful accessory for ensuring exact height of the blocks. Figs. 147a and 147b represent the usual forms. Another kind re-

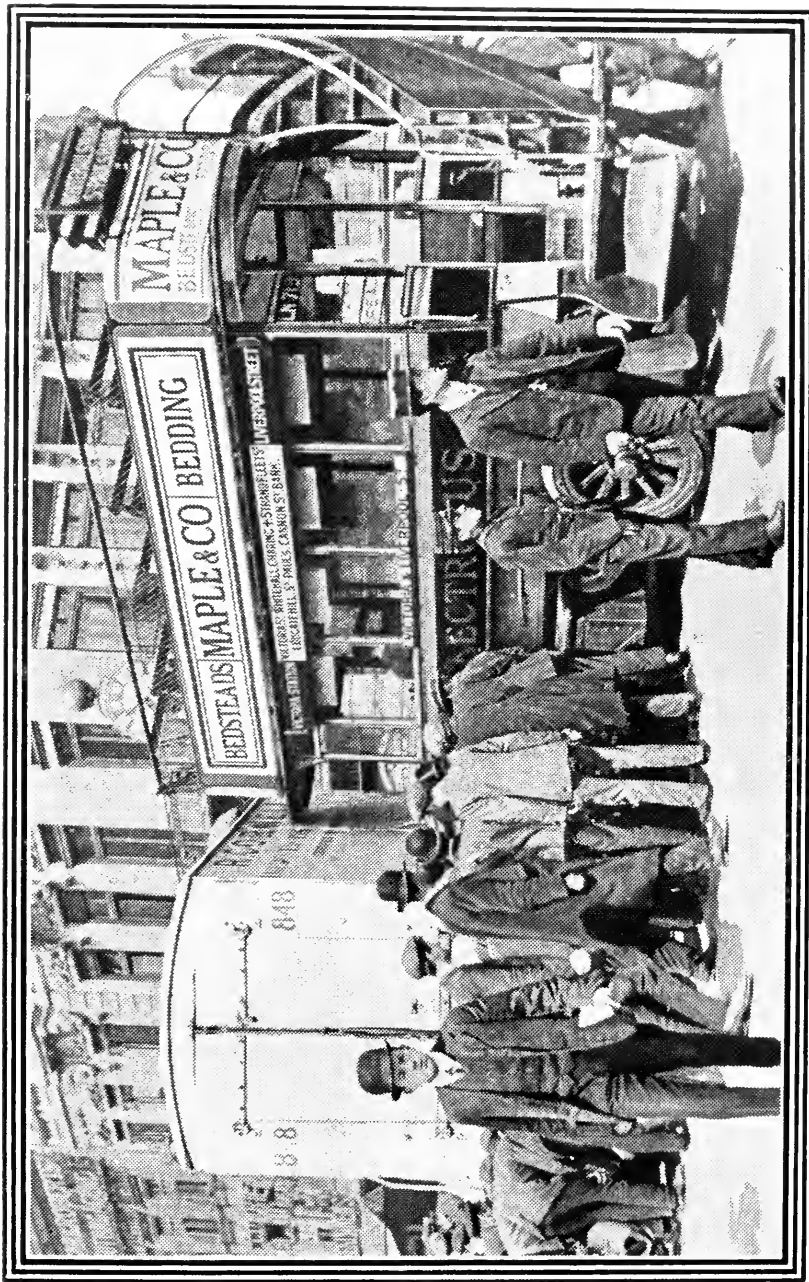

FIG. 147a.

cently introduced has a spring plunger, which rests on the block, and the height is registered by a pointer moving over a scale above the machine. The English type height is .917in.



FIG. 147b.



"Daily Mirror" Block.

A STREET ACCIDENT.

Photo H. H. Marshall.

CHAPTER IX.

PROOFING.

THIS department has become a more and more important part of a photo-engraving establishment of late years, as a good deal of the commercial success of the firm depends on the sending out of good proofs, such as will impress the customer, and the printer who has to handle the blocks, with the quality of the work.

It is desirable that the proofer should be provided with a room, or partitioned-off enclosure, apart from the other departments, as it is very essential that his ink and paper should be kept clean. He should have a good light, a fair amount of space, and a solid floor.

Formerly it was customary to use ordinary printers' hand presses, such as the "Albion" and "Columbian" in England, and the "Franklin" and "Washington" in America, for the work of proof-pulling; but it was soon found that these presses were by no means strong enough to withstand the enormous pressure necessary for obtaining a good black pull from a half-tone block. These presses always seemed to pull hollow in the centre of the block—that is to say, whilst the pressure would be too heavy at the margins, the centre would be grey. In attempting to apply increased pressure many presses were broken across the pillars or in other weak portions.

These difficulties led to the introduction of presses specially designed for the requirements of photo-engravers, and of these the

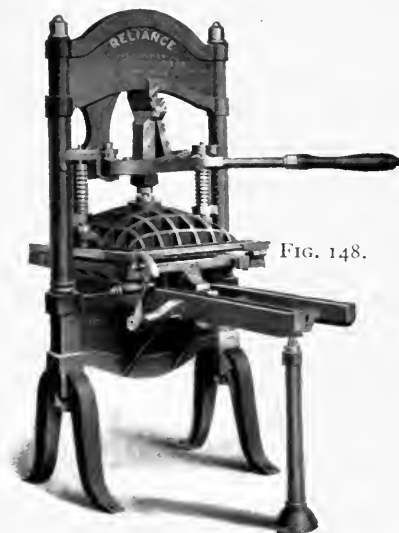

FIG. 148.

“Reliance” is typical (fig. 148). Its feature is that an enormous mass of metal is built up towards the centre of the platen, and also underneath the bed. The strain of the pressure is taken by heavy steel rods running through the side columns, and the impression is applied by a well-designed system of leverage applied to a

toggle joint, so that one man is able to exert an enormous pressure. It is claimed for these presses that almost the full printing surface is available instead of about half the area, as was the case with the older forms of presses.

Another form of press that has come largely into use of late years is of the style fig. 148a, which, it will be seen, is of the type used by book-binders, and known as the “blocking press.” It has great power, and pulls up to the

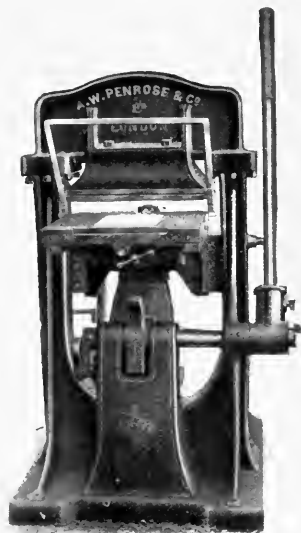

FIG 148a..

limits of its bed. Further, it has the merit of requiring less floor space than the ordinary style of presses.

A useful, in fact, almost indispensable, accessory to the press is a carefully-planed cast-iron block upon which to lay unmounted plates. This block is the same height as a piece of mounting wood, so that it brings the etched plate to type height.

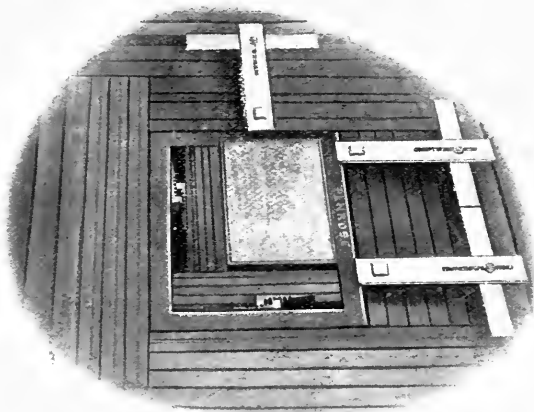

FIG. 149.

For colour work, registering gauges can be obtained. These have the appearance of fig. 149, and the paper is fed up against the little projections on the steel placed near the margins of the block. If the second and third blocks of the three-colour set are placed in the same position, and the gauges left undisturbed, the sheet should register accurately, provided only that the plate is square on the mount and of identical size with its two companions. Another device for

colour proving is that shown in fig. 149a, which has an advantage over the previous one in having micrometer screws for adjusting the stops.



Cox's patent register quoins (fig. 150) are also very useful in two and three-colour printing. These quoins are made of hardened steel, and the two parts are connected with a screw, which is operated by a spanner inserted between the two parts. By loosening

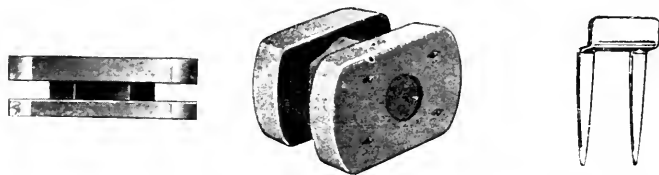

FIG. 150.

FIG. 150a.

one quoin and screwing up another opposite to it the block can be moved without unlocking or loosening the forme. Perfect register is quickly obtained, and the moving of one block does not disturb the others in the slightest. The adjustment can be made to $\frac{1}{1000}$ in.

Gauge pins (fig. 150a) can also be obtained for fixing to the tympan to hold and adjust the sheet.

An iron ink table, or a wooden bench with a lithographic stone on it, is required for the ink distribution.

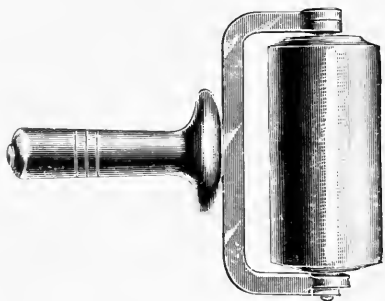

FIG. 151.

The rollers are of the letterpress kind (fig. 151), as a rule of glue composition, but some men prefer the lithographic stock coated with the same composition. Separate rollers and slabs

should be kept for colour work, and, if possible, a separate roller and slab for each colour, for obvious reasons.



FIG. 152.

A paper knife for cutting up the proof paper (fig. 152), a pair of long shears (fig. 153) for trimming off margins, a pair of small scissors for cutting out large overlays, and an overlay knife (figs. 154 and 155) for cutting out intricate overlays are usually provided for



FIG. 153.

the use of the proofer, as well as a set of ink knives, a turps

or benzine can (fig. 153a) (so arranged that drops can be shaken out without removing the stopper), about complete the modest requirements of the proofer. A good bench on which to lay out his paper and proofs should be provided alongside the press, and it should have drawers in it, trays for paper and for blocks,

and a cupboard for the rollers and inks, if the very best accommodation is desired.

In large establishments it has become quite a common practice to add a platen power press, such as those known as the "Colt," "Victoria," and "Phoenix," which are typical and very popular types of this class of machine. Orders for printing from the blocks are undertaken, the assumption being that the customer will have confidence in the photo-engraver getting the best possible result from the blocks. Moreover, the photo-engraver has the opportunity of running off his own specimens. But probably the chief reason that has led to the introduction of these machines into the photo-engraving establishment is that it is believed they are better adapted for the proofing of three-colour work than hand presses, owing to the automatic inking features and registering apparatus. Some photo-engraving firms have gone still further, and



FIG. 153a.



FIG. 154.



FIG. 155.

introduced stop-cylinder or two-revolution presses for dealing with three-colour work, on the ground that the blocks were so inadequately printed by the average letterpress printer. There has, however, been a great improvement in the handling of half-tone and three-colour blocks of late years by the printing trade.

CHAPTER X.

THE MATERIALS USED.

IN order that the working instructions for the processes may be kept as concise as possible, and unbroken by the interposition of descriptions of the materials employed, the author considers it the best plan to devote a separate chapter to this subject, so that the worker may be familiarised with the articles before he proceeds to handle them, and also enabled to see what is required when commencing business.

Silver Nitrate.—This important chemical is used for the preparation of the sensitising bath in the wet collodion process. It is prepared by dissolving pure silver in nitric acid, but can be easily obtained commercially in large flaky crystals. Pure silver nitrate undergoes no change when exposed to light, but if organic matter be present a black deposit is produced. The recrystallised silver nitrate should be used, and should be soluble in its own weight of water. Zinc, iron, lead, tin, and other metals precipitate metallic silver from solutions of silver nitrate, hence the reason for using great care in preventing foreign substances coming into contact with the bath. The solution is usually made up to the strength of thirty-five or forty grains per ounce; it should never be allowed to fall below thirty grains per ounce, and it is considered

fifty grains per ounce is the maximum density at which a silver bath can be worked, even this being too strong. The specific gravity of a silver bath solution at thirty-five grains per ounce is 1.069, and at forty grains 1.078. Consequently, as already pointed out in a previous chapter, specific gravity bulbs, graduated for either of these figures, can be employed for the purpose of keeping the solution up to uniform strength. When boiled down to half the volume of solution the specific gravity will be 1.116, assuming it is boiled down to a density of sixty grains per ounce, 1.135 at seventy grains per ounce, and 1.153 at eighty grains per ounce. It must be borne in mind that these densities are for a pure solution of silver nitrate at 60° F. For every 10° below 60° deduct one grain, and for every 10° above 60° add one grain. An old bath solution containing ether, alcohol, and iodides would not give a strictly correct indication, but it will be sufficient for the practical purposes of the boiling-down operation. There is no advantage in using "fused" silver nitrate, but the double or triple recrystallised kind, if it can be obtained, is of the greatest purity. It is no disadvantage for the silver to give a slightly acid reaction when made up, as the bath will in any case have to be acidified.

Collodion.—Mawson's collodion has become a standard article in this country, but a good many workers now make up their own collodion. The commercial collodion is usually sold with separate iodiser, so that the operator can iodise when required, and, if necessary, vary the proportions. Collodion is made by dissolving

cotton, which has been treated with a mixture of nitric and sulphuric acids, in ether and alcohol. The nitrated cotton can be purchased ready prepared under the name of pyroxyline or gun-cotton. The quality of the collodion depends almost entirely on the kind of pyroxyline used, and it is necessary that anyone attempting to make collodion should be thoroughly familiar with the peculiarities of pyroxyline.* The proportion of ether and alcohol to be used will depend on the place in which it is to be worked. For cold climatic conditions the alcohol and ether may be as 4 : 5, whilst in summer the proportions will be equal. A good formula for the manufacture of process collodion is given in Chapter XI. Instead of using pyroxyline and risking its uncertainties, celloidin is to be recommended. It is sold in dry, flaky chips,† and will keep indefinitely (although sometimes losing in weight). The chips are dissolved by first soaking in the alcohol, and then adding the ether. Any approved form for iodiser may be used, and it is usual to keep back a portion of the alcohol for dissolving the iodides before adding to the collodion. For the purpose of stripping the films from the glass a special collodion is prepared, in which castor oil is introduced to render the film flexible.

Iodides and Bromides.—Before the collodion can be used it requires to be “iodised.” This consists in adding to it iodide salts dissolved in alcohol. The iodides of ammonium, cadmium, potassium, strontium,

* Those who desire to make collodion, or to understand the chemical principles involved, should study Hardwich's "Photographic Chemistry" and Abney's "Instruction in Photography."

† Of late makers have supplied the celloidin moistened with alcohol.

lithium, and zinc are used, the two first being the most employed. Bromides of ammonium, cadmium, potassium, etc., are also sometimes added. These salts combine with the silver nitrate from the bath to form iodide or bromide of silver in the collodion film, acting as a vehicle on the plate. The bromides have the property of conferring speed, whilst the iodides ensure a clean, dense image. Great care should be taken to obtain these salts of the utmost purity, and they should be kept in clean glass-stoppered bottles, away from light and air, as some of them change colour by exposure to light, and they also become deliquescent by the action of the atmosphere. The formulæ for making up these salts will be found in Chapter XI.

Developers.—Wet collodion plates are universally developed with iron sulphate, acetic acid and alcohol being added to the solution. Collodion emulsion is developed by hydroquinone or glycin. These two latter compounds are equally suitable for gelatine dry plates. Formulæ will be found in Chapter XI.

Indiarubber Solution.—To ensure the collodion film holding on the glass, it is usual to paint the margin with indiarubber solution. This consists of the purest Para rubber cut into shreds and dissolved in benzole to the consistency of collodion. The rubber edging dries quickly, and serves equally as well as the albumen substratum, without any of the disadvantages of the latter, such as picking up dust and contaminating the bath. Indiarubber solution is also used for stripping films. The negative is first flowed with rubber solution, and when this is dry, flowed again with the stripping collodion already described.

The other chemicals for the wet plate or other negative-making process need no special description. They are standard commercial chemicals, and it is only necessary to order them correctly by the names given in the formula from a reliable dealer who is familiar with the purposes for which they are required.

Albumen.—The albumen used in photo-engraving processes is egg albumen. This may be obtained from the whites of fresh eggs, or the dried egg albumen may be used. The latter is to be recommended, because eggs vary so much in size ; to state that the whites of so many eggs are to be taken would therefore be very inexact. Moreover, eggs vary in their degree of freshness, so that results would be in some cases doubtful. By using dried egg albumen, which differs from the albumen from eggs only in the fact that it is denuded of water, greater uniformity of results is assured. It should be purchased in the powdered, not crystalline, form, as the latter is troublesome to dissolve. The powder is of a whitish yellow nature, and as it is easily adulterated it should be obtained from a reliable dealer who knows the purpose for which it is required. The question is frequently asked : What proportion of dried albumen corresponds to the white of an egg ? It is obviously one upon which no very exact answer can be given ; but it has been stated that fresh eggs contain eighty-six per cent. of water. From this it may be deduced that fourteen parts by weight of dried albumen to eighty-six parts by weight of water will equal the density of fresh egg albumen. This will work out at about one dram of albumen to one ounce of water,

and for all practical purposes it will be near enough to use one dram of dried albumen where one egg is specified. The dried egg albumen is added to the water and beaten up with an egg whisk in the same way as the white of egg. Albumen is used as a substratum for collodion negatives ; for mixing with fish glue in the enamel process ; and by itself in combination with a bichromate in the sensitised coating for printing line negatives, as well as half-tone negatives in some processes. It is said that dried albumen when used with a sensitising salt is very slow. If fresh egg-white is used, it should be measured after whipping and settlement.

Fish Glue.—There are several varieties of fish glue, but the kind most suitable is labelled “ Le Page’s Photo-engravers’ Clarified Glue.” This form is cleared of all gritty sediment, and though it is thinner, and therefore does not go quite so far as the “ ordinary ” kind, it is cheapest in the end. There are some few workers who still cling to the “ ordinary ” fish glue, labelled “ F20,” but it requires a lot of filtering, and often develops oily spots on the plate. Fish glue is supposed to be extracted from fish skins, etc., and it is rendered permanently liquid, either by long boiling or chemical treatment. The preservative added to make it keep is believed to be oil of winter-green. The glue should be practically free from acid for photo-engravers’ purposes ; it is not always uniform in quality, and appears to be affected by atmospheric changes, sometimes washing away too freely when developed, and at other times leaving an insoluble

scum on the plate. The worker must get to know the peculiarities of the glue, and be ready to correct any differences, either by varying the proportions of the other ingredients of his solution or by altering the exposure. Lately a dried fish glue in scales has been introduced, and only requires dissolving in a little hot water, after which it remains permanently liquid.

Bichromates.—The bichromate salts are a very important consideration to the process printer, as they form with some colloid the sensitive compound which enables him to print the photographic image on to the metal. For processes in which the film has to be inked prior to development, potassium bichromate is generally used, whilst for the fish glue enamel process ammonium bichromate is always employed. The former salt is not nearly so sensitive as the latter. Both are obtained in bright orange crystals, the ammonium salt being the darker of the two. Sodium bichromate is also obtainable, but little used, being a deliquescent and somewhat uncertain salt. The action of the bichromate is to cause the albumen or fish glue or gelatine with which it is mixed to become insoluble in the parts exposed to light. Thus a film exposed under a negative will have certain parts hardened, whilst the other parts corresponding to the white portions of the picture will wash away when treated with water. Whether the potassium, ammonium, or the sodium salt is used, the action is the same, and the worker who should unexpectedly run short of one salt can easily resort to the other. The chemical action depends on the reduction of the chromic acid in the

bichromate to a lower state of oxidation, hence it is usual to add chromic acid to the fish glue solution to hasten the action, another possible effect of the chromic acid being to toughen the film and make it hold better on the metal.

Nitric Acid.—It is not necessary that this should be pure for etching zinc. The commercial variety is good enough. It is sold by weight, and by the carboy or half-carboy, weighing respectively about 112 lbs. and 56 lbs. The carboys should not be tightly stoppered, as they are liable to explode in hot weather, if the gases generated cannot escape. The acid may be tested by means of a Beaumé hydrometer, and should register about 44° . The test is not always a conclusive one, as sulphuric acid, which is cheaper than nitric acid, is often added to increase the density. The acid gives off brown fumes at full strength, which are very injurious to health. Nitric acid is always diluted for etching purposes.

Perchloride of Iron.—This is sold on the market in large yellow rock-like lumps, which rapidly become darkened and moist by exposure to the atmosphere. It should be kept in stone jars, and is dissolved by adding water. Roughly speaking, 1 pint of water to $1\frac{1}{2}$ lbs. of perchloride makes a solution of the strength necessary for etching, but the solution is always measured by floating in it a Beaumé hydrometer, which should register 40° to 45° . The solution should be kept up to this strength by adding more of the solid, or of a saturated solution. “Persal” is a purified form of perchloride of iron.

Powdered Alum is used for making up an etching bath with nitric acid for the purpose of matting the surface of zinc plates (technically called the "passing bath"). This is the ammonia alum as usually supplied for photographic purposes.

Chrome Alum is sometimes added to the etching bath, its object being to harden the film, this chemical having a hardening action on gelatine, glue, etc.

Chromic Acid is recommended in some enamel formulæ, to increase sensitiveness and make the film hold better on the metal by hardening the glue acted on by light. The chromic acid should be pure, in fine, needle-like purple crystals, not the red efflorescent variety used for electric batteries.

Inks.—Although the practice of making the sensitive film itself resist the etching has practically made the use of inks obsolete in half-tone work, there are occasions when the worker must resort to them, and it is desirable that he should be familiar with their properties. *Photo-transfer* or transfer etching ink is a fatty, waxy compound, composed of such substances as wax, stearine, mutton fat, and lithographic printing ink. Thinned down with rectified turpentine, it is applied in a thin coating to a printed film of albumen bichromate, or to a gelatine film of photo-lithographic transfer paper after exposure. *Lithographic ink* is used to reinforce the transfer ink image. It consists of lampblack, boiled linseed oil, and fatty matter, and is thinned down for use with lithographic varnish (boiled linseed oil) "*Starting*" ink follows the lithographic ink, building up a stronger resist. It is com-

pounded of lithographic and thin letterpress printer's ink mixed with resin, asphaltum, beeswax, and other similar ingredients melted together. This ink is also thinned down with lithographic varnish. *Finishing ink* has much the same ingredients as "starting" ink, but the resin, asphaltum, and beeswax are in excess, so as to make a very hard ink ; it is thinned down with turpentine. *Proving ink* is simply a good letterpress printing ink, of much higher quality than ordinarily used by printers, being stiffer and richer in depth of colour ; it should not be thinned down with any varnish or other medium, but if difficult to distribute, a little ink of a thinner consistency is mixed with it. *Lithographic writing ink*, used for the purpose of ruling border lines or retouching on the plates, writing in imprints, etc. ; this ink is sold in sticks wrapped in tinfoil, and a little of the latter is peeled off at the end, so as to expose the ink, which is rubbed on the side of a warm saucer containing a little distilled or rain water (ordinary tap water curdles the soap in the ink). This ink is used with a fine brush or a lithographic pen, and in the ruling pen. Liquid lithographic writing ink is sold, but it is not considered so satisfactory, the ink being required of a good consistency, so that it may be sticky enough when warmed to attract a resinous powder brushed over it to increase its resistive properties.

Etching Powders.—Under this heading we have to consider resin or colophony, asphaltum, dragon's blood, and one or two specially made up powders. *Resin.*—The finest consists of the light yellow variety, and the same is heated to drive off volatile constituents,

then ground very finely in a special mill arranged with a blower arrangement to keep the resin separated in fine particles, the tendency being to clog together. The powder must be sufficiently fine to go through a 120-hole sieve, or even finer. It must be kept in a cool, dry place in a tin or stone jar. *Asphaltum*.—For dusting purposes, a bitumen rich in pitchy matter is best, and when finely ground it has a brown snuff-like appearance. It is a better resist than resin, and never really melts, only softening and combining with the ink. By itself it would be useless as an acid resist, as it would be granular on the plate. When strongly heated it holds very tenaciously to the plate. Good combinations can be made by mixing beeswax with asphaltum, as is done for photo-lithographic purposes, and by mixing pitch, resin, and asphaltum, which form an exceedingly strong resist. *Dragon's Blood*.—The red powder bearing this peculiar name is a very powerful resist, and one of the most valuable of all etching powders. It is a resin extracted from a tree in the East Indies. When powdered, it has a rich, dark crimson colour. It is soluble in alcohol, but not in turpentine or benzole. After being brushed on the plate, so that it adheres to the ink, it is heated until it becomes a deep chocolate brown. As the powder is useless when adulterated with resin or with earthy compounds, as it too frequently is when bought at a low price, care should be taken to see that it is of the best quality. A little placed on a strip of paper and a light applied to it will melt and run together with a bright black surface if pure.

Acid Resist Varnishes.—*Shellac varnish* is generally used for coating the back and margins of the plates

for the purpose of preventing their being etched. It is simply made by dissolving shellac in alcohol (methylated spirit). *Stopping-out varnish* is also a shellac varnish, but thickened with other ingredients, and mixed with a strong aniline black. It is thinned by means of methylated spirit. Asphaltum dissolved in turpentine alone, or with a little benzole, is often used as a stopping-out varnish. Better still is Brunswick black, which is much the same thing, but has finely-ground lampblack mixed with it. Bates's black makes a good stopping-out varnish. Some workers stop-out with finishing ink thinned down with turpentine. A new varnish called "Mogul" lately introduced is very good and cheap.

Zinc.—Formerly most of the etching, both in line and half-tone, was done on zinc, which, owing to its cheapness and adaptability to the processes, was found to be the most suitable metal for the work. Although copper has largely superseded zinc for half-tone work, the latter metal still remains supreme for line work, and is also largely used for photo-lithography. The quality of the zinc used in the etching processes is an important factor in their rapid and successful working. The best zinc for etching purposes is mined in Asturia (Spain), but is prepared in France. The Belgian zinc, of the Vielle Montagne, is a good zinc, but often uneven in quality. When good it is hard, and etches evenly. The Silesian zinc is pure, but very soft; it is more usually adopted for line work, owing to the rapidity and smoothness with which it is etched with nitric acid. English zinc, mined in Wales and Cornwall, is generally too full of impurities to be used for

photo-engraving. American zinc seldom finds its way into Europe ; it is exceedingly hard, brittle, and not very pure, being accordingly difficult to etch. The heating necessary for burning-in the enamel in the half-tone process renders zinc soft, crystalline, and brittle, hence it is generally only used in processes where there is no excessive heating. The etching of zinc is invariably done with nitric acid, and, as a rule, the surface is matted before applying the sensitive coating. The zinc, as purchased for photo-engraving, is flattened, planished, and highly polished. It would not pay to polish the metal oneself. The polishing is done by machinery fitted with rapidly revolving buffs charged with abrasive powders. There are two kinds of polish, one known as "straight," in which the polishing marks run in straight lines from end to end of the plate ; and the other known as "round," the polishing marks forming circles all over the plate. It is generally considered that the "round" possesses the highest polish and flatness, and is the best for half-tone.

Copper.—This is by far the most used metal for the half-tone process. Its use became necessary on the introduction of the enamel process about 1892-93. Copper will stand almost unlimited heating up to the melting point without deterioration, and it etches very smoothly and rapidly with iron perchloride in solution. The best and cheapest copper comes from America, and is largely imported into Europe, the purest being that manufactured by electrolytic processes. The American copper is somewhat softer than that manufactured in Europe. Good, hard copper comes from France and

Germany, and high-class copper is prepared in England for photogravure purposes, but is very expensive. It is hammered, planished, and polished by hand, whilst the American and Continental copper is generally rolled and machine polished. American copper when etched has a clean pink tinge, whilst European coppers usually have a dark scum formed in etching. The American copper is invariably "straight" polished, and has not a very high polish. This is considered an advantage—in fact, American workers generally polish their copper with charcoal before applying the sensitive coating. European copper is usually "round" polished and of high finish; it is, as a rule, used with its original surface, the greasiness being first removed.

Brass.—Although this metal is cheaper than copper, and possesses many of its advantages, it is not extensively used. It is as easy to cut and bevel as copper and zinc. Brass is etched with iron perchloride. Good brass for etching comes from Germany. A great advantage of brass is its hardness.

The thicknesses of plates mostly used in photo-engraving, whether zinc, copper, or brass as measured by the Birmingham wire gauge, are 14, 15, or 16, though, as a rule, 15 is ignored and 14 is used principally for line work, 16 gauge being the accepted thickness for half-tone plates. Copper is generally used in 16 gauge for half-tone work, though 18 gauge is now often used for motives of economy.

It should be remarked that Birmingham wire gauge must not be confused with Birmingham metal gauge, which gives quite a different series of numbers, nor with the standard wire gauge, which is slightly different

from the Birmingham wire gauge. It is a pity that the gauge is not expressed in millimetres, as on the Continent. There are several different versions of the Birmingham wire gauge, but the approximate equivalents are as follow :

No. 14 B.W.G.	=	·083in. or 2·108 mm.
15 ..		·072 1·828 ..
16 ..		·065 1·650 ..
18 ..		·049 1·244 ..

Steel.—For intaglio printing, steel plates have been used of late, the image being put down on them by the enamel process from a positive, and the plates etched with iron perchloride or with various special etching fluids which each firm holds as a secret. For power presses the plates are about $\frac{1}{4}$ in. thick, and have to be hardened before printing. The exact method of hardening is not known outside the establishments using the processes, but it is a difficult operation, requiring great care to avoid the plates being cracked or warped. Generally speaking, the process consists of heating the plate and then immersing it in water or some special solution, much in the same way as tools are hardened.

Mounting Wood.—For bringing up the metal plates to type height oak and mahogany are principally used by English houses, but in America cherry, birch, and beech are used. The latter woods have nothing like the same durability as oak and mahogany, and they are more apt to warp and swell. Laminated wood has been introduced, consisting of several layers of the same or different woods glued together opposite ways of the grain. Mounting wood can be purchased ready planed to suit the gauge of the metal.

Mounting Metal.—Plates are sometimes required mounted on metal. This is always requisite where plates have to be stereotyped. The plates are either soldered or tacked on with short brads. The metal is similar to type metal, but somewhat softer. It can be purchased ready planed to gauge from electrotypers or stereotypers, but it is not difficult for a photo-engraver to cast it himself, with a metal pot and casting box. The blocks may be cast solid, or may have a cored back, which lightens them considerably. There are also now on the market various forms of iron mounting blocks which hold the plate on with catches.

PART II.
THE OPERATIONS.

CHAPTER XI.

THE PHOTOGRAPHIC OPERATIONS.

BY common consent wet collodion holds the field for process negative making in commercial work, because it is believed to be cheaper to work, and the peculiar character of negatives desired can be obtained more easily by its means than by dry plates. It has been demonstrated over and over again, however, that suitable gelatine dry plates can be used, and give satisfactory results. The beginner or the worker in a small way of business will probably use dry plates, and therefore instructions for their use are appended. Collodion emulsion is also largely employed, its use being stimulated by its great adaptability for three-colour negative making by reason of the ease with which it can be colour sensitised. A well made negative on collodion emulsion is in no way inferior to wet collodion, and the working is no more difficult, but the manipulations require greater care in regard to cleanliness and accuracy of making up the solutions.

WET COLLODION PROCESS.

The Silver Bath.—The volume of solution to be made up will be proportionate to the dimensions of the largest picture the camera will take. In case the dipping bath is used, the quantity can be determined by measuring water into it until filled. The horizontal bath will only require about half the quantity of

solution that a dipping bath requires for a given size plate. We will presume that an 80-ounce bath is to be made up. The strength of silver is 40 grains to the ounce. A simple multiplication sum shows us that 3,200 grains of silver nitrate are required (= 7 ounces 2 drams $17\frac{1}{2}$ grains avoirdupois weight). We need not weigh it to half a grain; one scruple (= 20 grains) will be the nearest weight to put on the scales for the odd $17\frac{1}{2}$ grains. The silver should always be weighed on clean paper, an equal size piece of paper being placed in the opposite scale-pan. To prepare the bath, take 80 ounces of distilled water, and to a portion of this in a clean white glass bottle add the silver, shaking up till all is dissolved. Then add 15 grains of potassium or ammonium iodide (the proportion is about half a grain to every 100 grains of silver) dissolved in a little water. Instead of iodide, a minim of iodised collodion to each ounce of bath solution may be added. Some operators simply collodionise a plate and let it remain in the bath about half an hour. Shake up thoroughly after iodising, add the remaining water, filter the whole, and add 30 minims of pure nitric acid. The solution, if now tested with blue litmus paper, should turn the latter slightly red. The funnel used for filtering the bath should always be kept for that purpose, and the bottle in which the solution was mixed should likewise be reserved for emptying the bath into.

Another way of making up the silver bath is to take 1 part (1 ounce) by weight (480 grains per ounce) of recrystallised silver nitrate to 12 parts (fluid ounces) by measure of distilled water. This will make up a strength of 40 grains per ounce.

To iodise the solution, coat a plate with iodised collodion, and leave it in the bath some hours or overnight. If the bath does not work clear, add 1 drop (or minim) of pure nitric acid to 20 ounces of solution. Keep up the strength the bath to 40 grains per ounce by adding silver daily from a stock solution, after testing with argentometer. The stock solution need not be made up stronger than the bath solution, but if it is it should not be stronger than fifty grains of silver nitrate per ounce of distilled water, which is practically ten per cent. It is a good plan to pour the bath into a bottle after each day's use, filtering at the same time. The bottle should have a mark on it showing the full amount required for the bath, and it can then be filled up to this mark with stock solution.

When the bath begins to give foggy negatives, it should be neutralised with a crystal of sodium carbonate, and then exposed to light for two days, this operation being termed "sunning." The solution is afterwards filtered, and again acidified, as in the case of a new bath.

Potassium permanganate may be used instead of sodium carbonate. A ten per cent. solution can be added to the bath until a muddy precipitate is formed and the bath assumes a pale violet colour, after which the bath can be put out in the sun. As soon as the bath is clear it is filtered, and the usual amount of acid added. Sometimes it is necessary to repeat the operation twice.

In course of use the bath will become charged with alcohol from the collodion, which will cause trouble. To get rid of the alcohol, the solution should be poured into an evaporating basin and heated until it measures half its bulk. It should then be made up to its original quantity by adding distilled water, filtering, reacidifying, and adding silver stock solution to bring it up to strength. Sometimes a bath, for no apparent reason, refuses to sensitise properly. This is due to the use of a strongly iodised collodion, which has released too much acid. The bath will work well after the addition of a little sodium carbonate or potassium cyanide. Sometimes by evaporation the bath becomes too strong in silver nitrate—it must then be diluted with distilled water.

Glass Cleaning.—Glass plates when new are soaked in nitric, sulphuric, or hydrochloric acid. A good formula is :

Hydrochloric acid	1 ounce	25 cc.
Water	20 ounces	500 cc.

When taken out of this solution the glass should be rinsed and polished with the following paste :

Methylated spirit	20 ounces	500 cc.
Tripoli	10 "	250 cc.
Iodine	2 drams	6.25 grams

Prepared chalk may be used instead of tripoli, and equal parts of methylated alcohol and ammonia instead of iodine. The polishing should be done with a chamois leather or a Selvyt polishing cloth. Papier Josef is also used for the purpose.

Great care must be taken that no powder adheres to the plate when it is taken into the dark room to

be coated. For this reason it is perhaps better always to give the final polishing with weak iodine in spirit.

For cleaning old glass, gelatine films are best removed by soaking in a saturated solution of washing soda, or, better still, caustic soda. Another good film-removing pickle (though bad for the hands) is :

Water	20 ounces	500 cc.
Sulphuric acid	4	..	100 cc.
Potassium bichromate	4	..	100 grams

For removing old collodion films the following is effective :

Water	20 ounces	500 cc.
Nitric acid	$\frac{1}{2}$ ounce	12.5 cc.

After taking the plate out of the film-removing pickle, swill and put in draining rack. Then get a linen rag charged with whiting, consistency of thick cream, and rub well both sides of the partially dry negative glasses, and put in a clean bath of

Water	20 ounces	500 cc.
Nitric acid	2	.. 50 cc.

Then rinse and albumenise as below.

Substratum.—Some workers prefer to coat all glass with a substratum of albumen, gelatine, or indiarubber. The following formulæ are good for this purpose :

Albumen.

Albumen	White of one egg	25 cc.
Water	20 ounces	500 cc.
or						
Dried albumen	25 grains	1.3 grams
Water	20 ounces	500 cc.
Liq. ammonia	5 minims	0.5 cc.

The albumen should be well beaten or shaken, allowed to settle, and then well filtered.

Gelatine.

Gelatine	25 grains	1.3 gram
Water	20 ounces	500 cc.
Liq. ammonia	40 minims	4 cc.
or		
Gelatine	25 grains	1.25 gram
Glacial acetic acid	2 drams	6.25 cc.
Chrome alum	5 grains	0.25 gram
Water	20 ounces	500 cc.

Indiarubber.

Pure Para rubber	60 grains	3.12 grams
Benzole	20 ounces	500 cc.

This solution of rubber is flowed over the plate. All these substrata will require repeated filtering before use.

Another way of preparing the plate, instead of using a substratum, is to dust it over with talc, and then rub off so as to leave no marks. This facilitates stripping.

Edging.—It is quite usual, instead of giving the plates a substratum, to apply a rubber edging. The rubber solution is made up as above. White of egg may be applied in the same way.

The Collodion.—The beginner will be well advised to buy a collodion of some well known make, but those who have had any experience in collodion manufacture may make up the following, which is a well tried formula :

Pyroxyline	$\frac{1}{2}$ ounce	12.5 grams
Sulphuric ether, sp. gr. .720	20 ounces	500 cc.
*Alcohol, sp. gr. .805	20 "	500 cc.

To bromiodise above, take

Ammonium iodide	40 grains	2 grams
Cadmium iodide	40 "	2 "
Cadmium bromide	20 "	1 gram
Alcohol, sp. gr. .810 to .815	5 ounces	125 cc.

* "Solvit" is a ready prepared solvent for pyroxyline now on the market, taking the place of the ether-alcohol mixture, and comes cheaper.

After making the above solutions, mix, let the resulting solution stand for a week, and carefully decant off the clear solution into the pouring bottle for use.

A general rule to remember in modifying collodion formulæ is that to secure clean crisp negatives the bromide should be diminished. A quarter of a grain to each ounce of collodion is held to be sufficient to secure cleanness in the shadows. If a decrease of contrast and more detail be required, the bromide is increased. The proportion of bromide to the iodides should be 1 part of bromide to from 3 to 5 parts of iodides. In the above formula it will be seen that the proportion of bromide in the collodion is about $\frac{1}{2}$ grain per ounce, and of bromide to iodide is 1 to 4. When iodised collodion is of a pale straw colour it is in its most sensitive condition, and this may be produced by adding a few drops of tincture of iodine to it. This addition of iodine is also conducive to bright images.

The Developer.—The iron developer is always used for wet collodion process negatives. The following is a suitable formula :

Iron protosulphate	1 ounce	25 grams
Glacial acetic acid	1 „	25 cc.
Water	20 ounces	500 cc.
Alcohol	$\frac{1}{2}$ ounce	12.5 cc.

It may be advisable to dilute the above to the extent of one-third its volume in working fine screens.

In some formulæ copper sulphate to the extent of one-eighth the quantity of the iron is added, and is said to give increased density, though its advantage is questionable.

Abney recommends as much as 30 grains of iron to the ounce for general purposes. Eder gives 15 grains of iron to the ounce for half-tone negatives. It is certainly an advantage to keep up the strength of the iron solution when working by electric light. A weak developer tends to strong contrasts.

The object in adding the acetic acid is to prevent the too rapid deposition of the silver, which, but for the presence of the acid, would take place all over the film. The acid is added in just sufficient quantity to regulate the reduction of the silver. The proportion given in the formula is a very good one. It may be useful to mention that nitric, sulphuric, formic, and citric acid serve the same purpose, and may be used in the emergency of running short of supplies.

The object of having alcohol in the developer is to make it flow over the plate. A film sensitised in an old bath repels an aqueous developer, which consequently flows in a greasy, streaky manner over the plate, but the addition of alcohol overcomes this tendency. After the bath has been used about a week it will be necessary to add another ounce of alcohol to the developer; and the older the bath becomes the more alcohol will be required, up to four ounces in each pint of developer. With a new bath no alcohol is needed. Methylated spirit is often used for the purpose, but it is best to use spirits of wine owing to the impurity of the former, unless "industrial" alcohol can be obtained.

The Fixing Solution.—Potassium cyanide is invariably used for fixing, but sodium hyposulphite

can be used. Cyanide is, however, easier to wash out, gives a brighter image, and does not cause the film to split on drying, as is sometimes the case with hypo. There is no definite standard of strength for the cyanide solution, because, as a matter of fact, the cyanide itself varies in strength between thirty per cent. to ninety-eight per cent. The former is generally used for photographic purposes, and for this the following formula will hold good :

Potassium cyanide	1 ounce	25 grams
Water	20 ounces	500 cc.

A little in excess of the quantity stated is of no consequence.

Redevelopment.—Either before or after fixing the density may be built up by redeveloper with an ordinary iron developer without alcohol in it, or with either of the following formulæ :

No. 1.			
Pyrogallic acid	40 grains	2 grams
Citric acid	40 to 80 ..	2 to 4 ..
Water	20 ounces	500 cc.
No. 2			
Ferrous sulphate	100 grains	10.4 grams
Citric acid	200 ..	20.8 ..
Water	20 ounces	500 cc.
No. 3			
Hydroquinone	100 grains	10.4 grams
Citric acid	60 ..	6.4 ..
Water	20 ounces	500 cc.

No. 1 brings up density more quickly than No. 2, but requires a correctly exposed negative on which to work. No. 3 has latterly become very popular on the Continent.

Whichever redeveloper be used, a few drops of silver nitrate solution (10 grains to the ounce) must be added immediately before applying it to the negative.

Intensification.—After the image is fixed, it is usual to apply the following solution :

A				
Copper sulphate	2 ounces	50 grams
Water	20 "	500 cc.
B				
Potassium bromide	2 ounces	50 grams
Water	20 "	500 cc.

Mix A and B together, and let the solution stand for twelve hours. When using, flow over the image until it is bleached a creamy white. After rinsing for about a minute under a good stream of water, apply the following :

Silver nitrate	2 ounces	50 grams
Water, distilled	20 "	500 cc.

A brownish black image should be produced. It is usual to follow with

Iodine, resublimed	20 grains	1 gram
Potassium iodide	40 "	2 grams
Water	20 ounces	500 cc.

This changes the metallic silver to a state of iodide, after which the image can be "cut" or cleared with

Potassium cyanide	1 dram	3.12 cc.
Water	20 drams	500 cc.

Finally the image is blackened with

Ammonium sulphide	4 ounces	100 grams
Water	20 "	500 cc.

This gives intense blackness, but a drawback to its use is the objectionable smell of the liquid ammonium sulphide. Sodium sulphide, which is in crystals, may be substituted with advantage. The formula will be :

Sodium sulphide	1 ounce	25 grams
Water	20 ounces	500 cc.

If insufficient density results, or if the reduction is carried too far, the operations of bleaching, iodising, cutting, and intensifying may be repeated.

Another intensifier which gives great blackness, and is invariably used for line work, is the lead intensifier :

Lead nitrate	$\frac{1}{2}$ ounce	12.5 grams
Potassium ferricyanide	$\frac{1}{2}$..	12.5 ..
Acetic acid, glacial	$\frac{1}{2}$..	12.5 cc.
Water	20 ounces	500 cc.

The acetic acid promotes clearness. The plate is immersed in this solution until it becomes an opaque yellow colour. It is well washed and rinsed with dilute nitric acid (about 3 to 5 minims of commercial nitric acid to the ounce of water) until the transparent parts are free from any deposit on them. Then the plate is blackened with ammonium or sodium sulphide solution as described above.

The mercury intensifier can also be used, but does not give such great density, and requires rather more care. The formula for it is :

Mercury bichloride	1 ounce	25 grams
Ammonium chloride	1 ..	25 ..
Water	20 ounces	500 cc.

The negative, after being well washed and fixed, is immersed in the above until bleached white, after which it is further well washed. Blackening is usually done with

Liq. ammonia, .880	1 ounce	25 cc.
Water	20 ounces	500 cc.

Ammonium or sodium sulphide (formulæ as above) may be used instead.

“*Cutting*” Solution.—It is usual to employ a reducing solution for the purpose of “cutting” (as it is termed) the dots. The effect is to clear away any deposit between the dots, and also cut off any ragged fringe at the edge of the dots, leaving them absolutely sharp and black. This cutting usually follows the application of

the copper and silver. The formulæ have already been given. Iodine solution is first flowed over the negative until the image is bleached a pale yellow. The plate is then rinsed, and a weak solution of potassium cyanide poured over at one even flow.

Instead of using the cyanide separately, it may be mixed with the iodine solution. In this case the cyanide solution is added to the iodine solution drop by drop until the deep sherry colour of the latter disappears and the solution is transparent.

After the application of the cyanide, or cyanide and iodine combined, the plate must be quickly rinsed and examined with a fairly powerful magnifier to see if the dots are correct. If insufficiently treated the solution is reapplied.

A solution of potassium ferricyanide and sodium hyposulphite, as used in the dry plate process, may also be used for "cutting," or a solution of ferricyanide and cyanide.

It is usual to apply the blackening solution of sulphide after the cutting.

To get great density it has been recommended to intensify first with copper bromide, then cut and reintensify with lead, finally blackening with sulphide.

Varnishing.—It is advisable to varnish the negatives to prevent the surface being rubbed or scratched. The negative should be floated with a five per cent. solution of gum arabic whilst wet, or with a solution of albumen, viz. :

Albumen, dried	60 grains	4 grams
Water	1 ounce	30 cc.

Stripping Films for Reversal.—In America especially it is the practice to strip the negative film from the original glass and to transfer it with a number of others to one large glass, so that all may be printed and etched at one time. When films have to be stripped, the glass plates should not be albumenised. They should be simply well cleaned and polished and edged with rubber to make the film adhere at the edges. After the negative has been finished and dried off it is flowed with rubber solution, which consists of pure Para sheet rubber cut into shreds and dissolved in benzole to the consistency of collodion (two per cent.) When the benzole has evaporated from the film, the plate is flowed with “stripping” collodion, for which the following is a good formula :

Methylated spirit	10 ounces	250 cc.
Ether	10 „	250 cc.
Gun cotton	100 grains	5 grams
Castor oil	30 minims	1 gram

Instead of collodion, celluloid varnish may be used. The film should be cut round with a sharp knife and the negative immersed in

Acetic acid	2 ounces	50 cc.
Water	20 ounces	500 cc.

until the film can be easily lifted on a sheet of paper, whence it is transferred to another glass plate.

Another way which is recommended and does not involve the use of stripping collodion and rubber solution is to strip immediately after finishing and before drying. The film is flowed with nitric acid, then rinsed, cut round, a sheet of paper squeegeed on, then lifted, and if reversing is required transferred to

another paper. Whilst on this paper it may be trimmed with a pair of scissors to exact size and transferred to glass previously flowed over with gum water or rubbed with smooth starch paste.

COLLODION EMULSION.

Ready-made collodion emulsion, which has simply to be spread on the plate and can be exposed wet or dry, can now be easily obtained. Dr. E. Albert's collodion emulsion is typical and well known on the Continent, where it is extensively used. Excellent emulsion is now made in England, and is rapidly gaining favour. The emulsion itself would be very slow but for the sensitising dyes which are added to it. These dyes appear to be eosine silver compounds, which have the effect of greatly increasing the speed of the emulsion whilst at the same time making it orthochromatic. The sensitising dye for half-tone work is marked A, and it brings up the speed of the emulsion much higher than wet plate or even gelatine photomechanical plates ; indeed, when properly sensitised, it is as fast as most gelatine orthochromatic plates. The plates are coated similarly to wet collodion, and after draining are placed, without washing and without being dried, in the dark slide for immediate exposure, keeping for about half an hour in the moist condition. The development is very rapid. The fixing is quickly done with sodium hyposulphite or with potassium cyanide. Intensification for half-tone work is done with copper-bromide, silver nitrate, and sodium sulphide or ammonium sulphide. Reducing or "cutting" is done with iodine and cyanide, after the manner

adopted with wet collodion. The films can also be stripped by the method already described for the latter process.

It can readily be seen that collodion emulsion has several advantages over wet collodion, chief amongst which is the abolition of the silver bath and the greater rapidity of exposure. The development and other operations are quite as quick, and the plates can similarly be dried off with heat.

The working instructions for collodion emulsion may be briefly summarised as below, and fuller details will be found in a book entitled "Collodion Emulsion," by H. O. Klein.

Start with a stock of new glass, and immerse for a few hours in

Potassium bichromate	2 ounces	50 grams
Sulphuric acid	3 "	75 "
Water	20 "	500 cc.

Rinse under the tap, and polish with an alcoholic solution of caustic potash or iodine, and finally polish with papier Joseph or with a clean pad of linen charged with a few drops of alcohol and ammonia.

Old negatives should be cleaned by immersing in strong caustic potash solution to remove the films, and then treated as for new glass.

A rubber edging can be given to the glass the same as for wet collodion, or a substratum of albumen or gelatine. A good formula is :

Water	20 ounces	500 cc.
Albumen	$\frac{1}{4}$ ounce	6.25 cc.
Liq. ammonia	5 minims	0.5 cc.

The plates must be dried in a cupboard free from dust, and with the application of gentle heat. The plate must be cool before coating with emulsion.

The emulsion is well shaken for at least two minutes to get the silver bromide thoroughly mixed up with the solvent, as they settle at the bottom of the bottle after standing. The plate is coated in the same way as for wet collodion.

As soon as the emulsion is "set" (which can be determined when the finger makes an impression on the surface), the plate can be colour-sensitised by pouring the "A" sensitiser diluted 1 : 10 with alcohol over the plate four times ; or if the sensitiser has been incorporated with the emulsion (1 part to 10 parts), it can be placed in the dark slide for exposure.

The developer recommended by Mr. Klein is made up as follows :

Sodium sulphite	2½ ounces	62.5 grams
Water, hot, distilled	4 "	100 cc.
Glycin	1 ounce	25 grams
Potassium carbonate	5 ounces	125 "

The above order of mixing should be carefully followed.

The solution forms a thick paste, and will keep for years if well stoppered. For use, dilute 1 part of glycin with 12 parts of water.

Those who prefer to make up the developer ready for use will find the following keep well :

Glycin	160 grains	8 grams
Sodium sulphite, crystals	1 ounce	25 "
Sodium carbonate	2 ounces	50 "
Potassium bromide	20 grains	1 gram
Water	20 ounces	500 cc.

Hydroquinone also forms a good developer for emulsion. In fact, it is considered by many workers

to be better than glycin for giving strong sharp dots. Glycin is apt to give a "woolly" dot, but yields a very clean negative. Hydroquinone may give rise to stains and other markings if the glass has not been thoroughly cleaned. By giving the plate a substratum these markings do not appear.

A suitable hydroquinone developer is as follows :

A				
Distilled water	20 ounces	500 cc.
Sodium sulphite	10 "	250 grams
Potassium carbonate	8 "	200 "
B				
Hydroquinone	1 ounce	25 grams
Water, distilled	4 ounces	100 cc.
C				
Ammonium bromide	1 ounce	25 grams
Water, distilled	4 ounces	100 cc.

Mix the three solutions and keep as stock. For use, dilute 1 : 10. This developer does not keep very well.

Collodion emulsion plates can be fixed with sodium hyposulphite or potassium cyanide. The strength of the hypo solution should be 1 : 4.

The plate must be washed *before* development, because the alcoholic surface repels the aqueous solution of the developer, and so causes streaks and markings.

The time of development should not exceed $1\frac{1}{2}$ to 2 minutes. Development can be performed whilst the plate is held in the hand or in dishes. The latter are preferable.

If the high lights are fully exposed, copper and silver for intensification, and cyanide and iodine for cleaning, will be found most suitable. The formulæ already given for wet collodion can be used.

The following reducing and intensifying method is preferred by some workers :

A					
Potassium ferricyanide	1 ounce	25 grams
Water	20 ounces	500 cc.

B.					
Hypo	2 ounces	50 grams
Water	20 "	500 cc.

for use mix

A	2 ounces	50 cc.
B	4 "	100 cc.
Water	20 "	500 cc.

The reduced and washed negative is next placed in the following intensifying solution :

Water, distilled	20 ounces	500 cc.
Potassium ferricyanide	1 ounce	25 grams
Lead nitrate	1 "	25 "

Dissolved and filtered. When the negative has become yellow right through it is washed, rinsed with

Hydrochloric acid	1 dram	3 grams
Water	20 ounces	500 cc.

rinsed again under the tap, and blackened with

Sodium sulphide	1 ounce	25 grams
Water	20 ounces	500 cc.

It is then rinsed again, flowed with hydrochloric acid, rinsed again under the tap, and flowed with

Gum arabic	2 ounces	50 grams
Water	20 "	500 cc.
Carbolic acid	17 minims	1 cc.

The plates may be dried by heat, and may also be stripped by first coating the film with rubber solution and then with stripping collodion.

GELATINE DRY PLATES.

It is best to use the kinds of dry plates made especially for "process," which are now being supplied by most dry plate makers.

Iford process plates have a speed of 16 Watkins, f'28 Wynne, and 25 H. and D. Iford half-tone plates are 30 Watkins, f'39 Wynne, and 47 H. and D. Penrose Graphic process plates are 45 Watkins, f'45 Wynne, and 70 H. and D.

The "process" plate was originally introduced for "line" work, but many half-tone workers prefer it to the "half-tone" plate because it gives a clean, dense dot more readily than the latter. The difficulty of making good half-tone negatives will increase as more and more rapid plates are selected, owing to halation and similar causes tending to spread and blur the dot images. On the other hand, if a very slow plate is used, there is a difficulty in bringing up the dots in the shadows. On the whole it is certainly more difficult to make a good printable half-tone negative on a dry plate than on a wet collodion plate. The common fault is that the transparent portions are veiled over before the necessary density can be obtained, and the high lights are closed up before the shadows have been sufficiently acted upon.

Experience has shown that to overcome these difficulties those developers must be selected which give very hard, dense black images without staining or veiling, also that the exposure should be full, and the negative strongly reduced and intensified.

Some operators think a plain hydroquinone formula, such as is given on the direction labels of most makers of process dry plates, is all that is needed.

The author has, however, found the following very satisfactory :

A.					
Metol	45 grains	2.25 grams
Hydroquinone	55 "	2.8 "
Sodium sulphite	120 "	6 "
Potassium bromide	30 "	1.5 "
Water	20 ounces	500 cc.
B.					
Caustic potash	180 grains	6.25 grams
Water	20 ounces	500 cc.

Take equal parts of A and B.

Mr. T. W. Lascelles, who has been very successful in using dry plates for half-tone, has published the following developers which he employs :

A.					
Hydroquinone	210 grains	11 grams
Sodium sulphite	2 ounces	50 "
Water	20 "	500 cc.
B.					
Sodium hydrate	330 grains	17 grams
Water	20 ounces	500 cc.

For use, take equal parts of A and B.

Fixing should be done in clean hypo solution of the following strength :

Hypo	5 ounces	125 grams
Water	20 "	500 cc.

The reducing solution should consist of

Potassium ferricyanide	8 ounces	200 grams
Hot water	20 "	500 cc.

Filter when dissolved.

Also make up

Hypo	4 ounces	100 grams
Water	20 "	500 cc.

Take equal parts of these two solutions and mix in a dish just before using. They will not keep after being mixed.

The above strength is for negatives that are very much closed up. For ordinary negatives dilute with equal quantity of water.

The writer considers that this application of the reducing solution is in all cases desirable in making

half-tone negatives, not only because it clears the plate from veil, but because it acts similarly to the reducing solution in the wet plate process, sharpening the edges of the dots, and reducing the size of the dots in the shadows. But to carry the reduction so far that the dots are reduced in size, it is necessary that there should be a good joining up in the high lights. The reducing solution should be poured on the negative with one clean sweep, so that it may act rapidly all over; then be poured off quickly, and the plate well rinsed under the tap. The dots can then be examined, and if not sufficiently acted upon the reducer is again applied.

Intensifying is best done by the mercury and silver cyanide solution, the formula for which is as follows:

Mercury bichloride	240 grains	12.5 grams
Ammonium chloride	240 „	12.5 „
Water	20 ounces	500 cc.

If after bleaching the negative is immersed in a solution of ammonium chloride, 20 grains (1 gram) in 1 ounce (25 cc.) of water, the washing which follows bleaching may be more quickly done.

The blackener is made up in two solutions:

A				
Silver nitrate	11 drams	34 grams
Water, distilled	20 ounces	500 cc.
B				
Potassium cyanide	11 drams	34 grams
Water, distilled	20 ounces	500 cc.

The silver nitrate is poured into the cyanide solution whilst continuously stirring, and a little precipitate should remain. When mixed the plate is immersed. Washing follows. As in most cases negatives for half-tone work have not to be kept, it is unnecessary to give them a great amount of washing.

It is a good plan to back the plates with some anti-halation medium, of which there are a number on the market. It should be something which dries quickly and is easily washed off before development. Lichtenstein's caramel with a little water and lampblack added is good. Backing gives greater freedom from grain between the lines or dots, and is quite worth the extra trouble. It is also an advantage to heat the back of the plates on an electric radiator until they are as hot as the hand can conveniently bear. The backing is then applied and dries instantly, whilst the heating is said to have the effect of contributing to greater sharpness of dot.

In working dry plates for half-tone it should be remembered that a long screen distance and small stop will give sharper and blacker dots, and the exposure is seldom more than one minute if the arc lamps are good and a stop is used with a diameter equal to one-ninetieth of the distance from stop to plate. Many operators use too large stops and over-expose the plate, so that they have to stop development too early. This results in large dots without any real density. Using the standard formula for development at 65° F. the image should be well through the plate in four to five minutes normally. It is better to cover the dish and keep it rocking, as the plate is thereby not liable to be fogged by stray light and gains density more quickly.

Greater care, of course, must be taken in using dry plates than with wet plates to see that the camera is light-tight and the dark room light-safe.

CHAPTER XII.

MAKING THE NEGATIVE.

LEAVING the dark room for a while, let us get the camera ready, and endeavour to understand fully its manipulation in regard to the half-tone process. The worker must be presumed to have some photographic knowledge, and therefore it is unnecessary to explain minutely the principle of the lens and camera.

Preliminary Precautions.—Parallelism between the original and the various parts of the camera is the first essential. Next, one should see that the lens, prism (or mirror), and ruled screen are quite clean and free from dust. Except the mirror, these should be polished with a very soft piece of silk (as an old silk handkerchief) or an old linen handkerchief, taking care that there is no grit in it or on the glass surfaces, as the highly polished glass used for the above pieces of apparatus is very susceptible to being scratched. Rouge, whiting, or similar substances should not be used. Instructions for polishing the mirror have already been given. If the inside of the camera is at all dusty, wipe it out with a damp chamois leather or sponge. The dark slide must also be dusted and wiped out, and a folded strip of blotting paper laid on the bottom edge of the carrier to receive the drainings of silver solution from the plate. It is most important that these drainings

should not be allowed to accumulate in the slide or on the bench, for the most perfect woodwork cannot withstand the action of the silver nitrate solution, which not only rots the wood and disintegrates the glue, but prevents even the wood, which is only partially attacked, from ever being glued together again. Further, if the silver nitrate is allowed to dry in the slide, it gives rise to a metallic dust, which is absolutely fatal to collodion emulsion work, and may cause trouble with wet or dry plate processes. It is, indeed, a mark of intolerable slovenliness and carelessness to see a dark slide with the bottom rotted out by silver solution, when five minutes spent at the beginning and close of the day or a few seconds between the operations would avoid it.

Fixing up the Copy.—The “copy” (as the original picture to be reproduced is always called) is pinned up with drawing pins on the board, unless the “Clip” copy-board is used, in which case pins are rendered unnecessary. It should be fixed upside down, so that it will come right way on the ground-glass, which makes it easier to focus. It is always easier to illuminate large copies by placing the longer dimension horizontal, in which case it is easy, of course, to drain the plate in the horizontal instead of the usual vertical direction.

The Illumination.—The placing of the arc lamps is very important, as it is difficult in some positions to avoid causing reflections from the surface of the copy, especially when the latter is of a glossy character. These reflections will lead the operator to suspect his

camera, prism, lens, screen, collodion, bath, developing chemicals—in fact, everything but the right cause—when he gets negatives with dense patches not corresponding to lights on the original.

It is a little difficult to explain without resorting to a geometrical diagram how these reflections reach the plate and how they can be avoided ; but if the operator will look upon his copy as a mirror he will readily see that he must place his lamps in such a position that if his eye were in the position of the lens he could not see their reflection in the mirror, and if they cannot be seen from the position of the lens it is obvious they will not be seen on the ground-glass.

The utmost light possible must be concentrated on the copy. The more intense the illumination the better will be the result. A copy exposed in a dull light, even if it is exposed proportionately longer, never renders so good a negative. To get the best effect of the light, it is well to spread a sheet of white paper on the bed of the copying stand just under the board ; this will reflect the light upward, and prevent the grain of the paper of the original showing up if at all rough. Likewise, if one side is unequally lighted, it is advisable to put up paper reflectors.

The two lamps must be placed at equal distances from the centre of the copy and from the surface of the board. A slight difference in the distances makes a great increase or diminution of the light, because of the rule that the intensity of light varies inversely as the square of the distance. For example : Twice the distance makes the intensity not twice but four times

less ; half the distance makes the intensity not twice as great but four times as great. It is most important that this principle should be fully grasped, in order that the operator may do rapid and successful work. He may more than halve his exposures by knowing the minimum distance he can place his lamps.

The intensity of the light may be still further increased by concentrating the rays on to the copy by means of a condenser. For small sizes a large reading glass may be used, and, in fact, it is the practice sometimes to concentrate the light by means of such a lens on the shadows of the picture during a portion of the exposure so as to help to bring up the shadow dots.

Focussing.—Focussing must be done carefully, and must always be done with the ruled screen in the camera and brought close up to the plate. The screen will darken the image on the ground-glass, and will make the focussing somewhat more difficult ; but experience and the strong light of the arc lamps will soon make the operator forget this difficulty. It is sometimes advantageous to take out the screen when focussing very fine work. In this case a difference of focus amounting to one-third the thickness of the screen will be made when the screen is put back. The focussing should be done with full aperture with anastigmat lenses, or with $f/16$ for rapid rectilinear lenses, and if there is no sharp detail in the picture a bit of printed paper should be pinned up alongside it.

The older types of rapid rectilinear lenses were always focussed at the centre, and stopping-down

resorted to in order to increase the circle of sharpness ; but the modern anastigmat lenses, notably the Cooke Process lens, require that an average sharpness over the whole plate be obtained, and the stop inserted to increase the general sharpness of the image, which may look a little hazy at full aperture.

A low power focussing eyepiece is an aid to sharp focussing, and is invariably used. The focussing screen may be rubbed with oil, all excess being wiped off until the screen is semi-transparent. A clear centre to the ground-glass, formed by cementing to it, by means of Canada balsam, a microscopic cover glass, is also a useful aid to focussing, and a means of observing the dot effect formed by the screen.

Choice of Diaphragm.—Let it be first understood that it is not possible to work with full aperture when using the ruled screen. If, when the lens is at open aperture, the operator applies the focussing eyepiece to the clear centre of the ground-glass and moves the ruled screen to and fro, he will see that at no position can he get a sharp image of the screen, and except when close up he cannot get any image of the screen at all. On diminishing the size of the diaphragm, however, it will be found that the image of the screen gets sharper and sharper until with the smallest diaphragm it is as sharp as the screen itself, even when the latter is a considerable distance away from the ground-glass. But it will also be found that as the screen image gains in sharpness the image of the copy loses in detail and contrast, and it is obvious that the more we diminish the size of the diaphragm

the more we shall increase our exposures. It appears to be necessary, then, to find the mean or average size of diaphragm that is best for the purpose. To determine this the operator must measure the distance between the diaphragm slot of the lens and the inner or ground surface of the ground-glass. He must also know what is the ruling of his screen—that is to say, the number of lines per inch. Now, the size of the diaphragm has a definite relation to the size of the screen opening (the mesh) and to the extension of the camera, measured as just described. Expressed in words it can be said :

- (a) The larger the screen mesh the larger will be the diaphragm.
- (b) Also: The greater the extension of the camera the larger may be the diaphragm used.
- (c) And, again, the further the screen is placed from the plate the smaller must be the diaphragm.

Clearly, then, to work out any calculation we must determine what distance the screen is to be placed away from the sensitive plate. Suppose we say, as close as we can get it. This will be the thickness of the pieces of metal which prevent the screen from falling out of its holder, plus the thickness of the cover glass of the screen. Together these usually make about one-tenth of an inch, which may be adopted as an easy figure for calculation.

Let x be the width of one side of the square stop, a be the width of the mesh of the screen, b the camera extension (distance of ground-glass from the stop), and c the distance of the ground-glass from the screen. Then, if the operator has not forgotten the "rule of three" which he learnt at school, he can figure out the following easy little problem :

Given that the camera extension is 20in., the screen 100 lines to the inch (= $\frac{1}{20}$ in. mesh), and the minimum screen distance is $\frac{1}{10}$ in., what will be the largest diaphragm that may be used ?

From the data given —

$$a = \frac{1}{200} \text{ in.}$$

$$b = 20 \text{ in.}$$

$$c = \frac{1}{16} \text{ in.}$$

x = the value to be found.

and from the facts already stated we arrive at the equation.

$$x = \frac{a \times b}{c} = \frac{\frac{1}{200} \times 20}{\frac{1}{16}} = 16 \text{ in.}$$

The average operator may find it troublesome to make this calculation every time, but fortunately he need not do so, as Penrose's "Pocket Book on Half-tone Stops and Screen Distances" gives tables showing the maximum stop and screen distance for all the usual screens and camera extensions.

It is also possible by practice to determine what stop will suit by inserting the stop and examining the clear glass centre of the screen with a powerful focusing eyepiece, when the shape of the dots will be seen, and by experience the operator will know whether they will join up. With a square stop placed with its sides at 45° to the lines of the screen, the effect will be somewhat that of a chessboard; but the operator must remember that it is the white squares which are going to act on the sensitive plate, so that the black squares must be isolated in order to produce joining up. The best way to get to know the effect is to set a screen distance and insert a diaphragm known by calculation or reference to the tables to be correct. Note well the effect through the eyepiece. Make a negative, with correct exposure, and see if the result is as desired. (The effect to be looked for will be subsequently described.) After repeating this a few

times the operator will soon get to know what to look for, but the result will be misleading if the exposure is not correct.

Shape of the Diaphragm.—In ordinary photographic work none other than the round diaphragm aperture is considered, but in the half-tone process a great

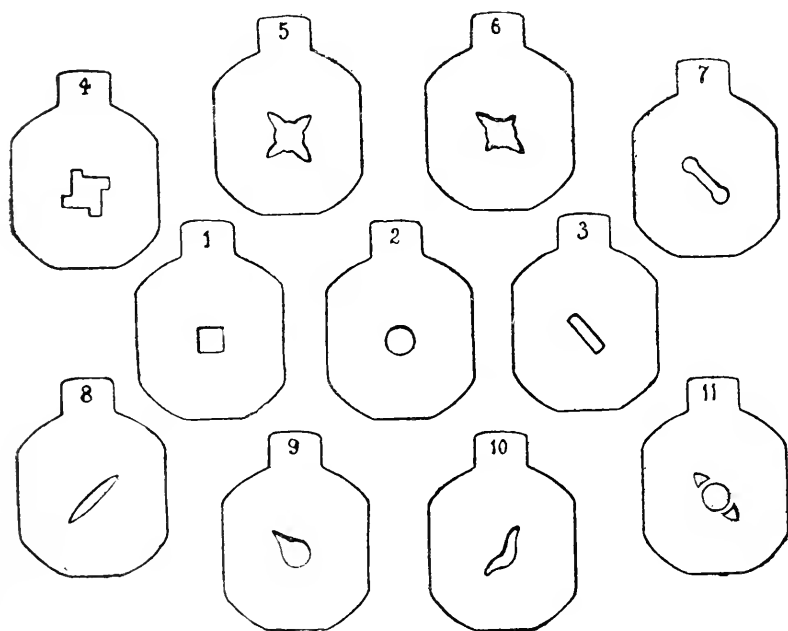

FIG. 156.

variety of shapes of aperture has been suggested from time to time by various workers. Fig. 156 will give an idea of the miscellaneous shapes which have been proposed and, in many cases, used, but as an outcome of experience there are practically only three general shapes which have to be considered, viz., the round, the square, and the square with corners

extended. Both the latter are embodied in the Penrose diaphragm system (see fig. 26), and if the underlying principle of these two stops is fully comprehended, the action of all others will be quite readily grasped.

It may, in the first place, be put forward as a general principle that the shape of the dot will conform approximately to the shape of the stop used. For instance, if we insert a square diaphragm in the lens, we shall get a square dot. When the square stop is placed with its sides at 45° to the lines of the screen, as is usually done, the dot will not be quite square, but will be almost octagonal in shape, because the screen has cut off the corners. If, however, we extend the corners of the stop the dot will tend to spread at the corners, and will accordingly restore the parts which the screen has cut off. This spreading action is technically known as "joining-up," and the operator strives to obtain this effect in the high lights of the picture, until in the finished negative the dots actually overlap at the corners and form a chessboard pattern.

If the reader will turn back to Chapter I., he will find this action of the diaphragm explained on the pinhole principle, each opening of the screen playing the part of a pinhole lens and photographing the shape of the diaphragm. Consequently it will be found that whatever the shape of the diaphragm, so will be approximately the shape of the dot—approximately, be it said, because the action is often disguised by other effects which it would be difficult to explain briefly here, and which in any case do not affect practical work.

Cross, star-shaped, and cushion-shaped stops are frequently used, all with the same object of promoting the joining up. Every operator appears to have his pet form of stop, and the beginner may be warned against trying every stop he sees or of which he hears, as it will lead him into everlasting muddle.

Standard shapes of stops suitable for half-tone work can now be obtained with lenses which are used for process work ; but if the operator wishes to construct stops for himself he may do so out of black cardboard, cutting out the apertures with a sharp knife after the centres and external shape have been outlined from an existing round diaphragm. It is to be remembered that in order to cut a square diaphragm which shall have the same effective aperture as a round one, the side of the square must be somewhat less than the diameter of the circle. Square stops made with the side the same size as the diameter of a round stop will work a little quicker.

To make a square stop of the same aperture as a round one, multiply the diameter of the round stop by .886, which will give the length of one side of the square.

Distance of the Screen.--From the considerations already stated it will be seen that the size of the stop and the screen distance are reversible values. It is quite possible to find a correct size of stop for every screen distance, or a correct screen distance for every size of stop. We may use a constant screen distance and vary the size of the stop, or we may use a constant stop aperture and vary the screen distance. The latter is in practice impossible, because a constant stop would not suit every screen ruling, as we have shown that

the screen mesh is one term in the equation when calculating the size of stop or screen distance. Further, we must vary the size of the stop in order to keep the exposures fairly constant, the exposures varying with the distance of the sensitive plate from the lens. If we only varied the size of the stop we should require a large number of stops varying in size by a small amount, and it would be very difficult to estimate exposures. On the whole, the English plan is to have a constant screen distance for any particular screen ruling, and vary the size of stop according to the Camera extension.

The following rules apply :

1. The screen distance increases as the camera is extended, and decreases as it is closed up. In other words, lenses of short focus necessitate the screen being placed closer ; and as the camera is focussed in for reductions the screen distance must be proportionately decreased.
2. Coarse screens allow of a larger distance from the plate. Fine screens require closer distance.
3. The larger the diaphragm opening the closer the screen must be placed to the sensitive plate. With smaller diaphragms it may be further away.
4. Screens with thin black lines are placed nearer ; with thick black lines further away.

A good way to find the screen distance is by direct observation with the "Midget" microscope (fig. 33). Set the focus of the microscope on the cross in the centre of the transparent spot at the centre of the ground-glass. Focus the picture sharply, put in the

stop, and gradually bring the screen towards the ground-glass. When the black chessboard-like squares join at the corners the screen distance is correct.

As a general rule it is best to keep the screen as far away as possible in order to get sharp detailed reproduction, bearing in mind, however, that if the screen is too far off the high lights will be over-joined; if too near the reproduction will be "wire-screeny." Therefore the operator must be warned against setting the screen distance too close and using too small stops, as this will give hard, screeny half-tones without roundness and gradation.

The Exposure.—If the exposure was made with one large size diaphragm, as in ordinary photography, the result would be that the high lights of the negative would be fully exposed before the dot effect had time to form in the shadows, whilst the middle tones would be also incomplete. The usual practice is to force the formation of dots in the shadows by inserting a very small round diaphragm in the lens—about half the size of that used for the main exposure—and covering up the copy with a sheet of white paper, which is sometimes moved about to prevent any image of creases or markings showing. The duration of this exposure may be about one-twentieth the total exposure. Its effect is to form small isolated dots all over the negative. A round or square aperture of the duly calculated size is next inserted, and the normal exposure given—such an exposure as will form the picture. The duration of this exposure will, of course, be longer than it would be if the

screen were taken away. With most subjects these two exposures will prove sufficient; but in the case of difficult copies—such, for instance, as are “flat” and wanting in brilliancy, having relatively dark high lights and light shadows—it may be necessary to give a supplementary exposure with the stop which has extended corners. This has the effect of joining up the high lights, but is ruinous to good gradation if carried too far. It is impossible to give any ratio for these exposures, which must therefore be found by trial.

Some operators prefer to maintain a fixed ratio between the size of the diaphragm and the camera extension. What is termed a “working aperture” is chosen. Suppose that is $f/96$. Then the extension of the camera is divided by this figure, and the result gives the diameter of the round stop. To make calculation easy, the distance from stop to plate is multiplied by 32 (bringing it to $\frac{1}{32}$ parts of an inch) and the product divided by 96, the result giving the diameter of the round stop in $\frac{1}{32}$ parts of an inch. This will be the stop used for the main exposure.

It is preferable to err on the side of slight over-exposure, as allowance must be made for the cutting down effect of the iodine-cyanide solution used for sharpening up the dots.

The nature of the copy will influence the exposure. A deep red-toned print will require the longest time. Platinotypes and bromide prints will require shortest exposures. A normal subject is a well-toned (slightly purple) silver print with glossy surface. Such prints require twice the exposure of bromides, platinums,

and bluish wash drawings. Average brownish silver prints and slightly yellow engravings, etc., require four times as long.

The Dark Room Operations.—If the wet plate process is used, the cleaning, edging, and collodionising of the plate, and the sensitising it in the silver bath are elementary operations which need not be more particularly described. Those who are unacquainted with the wet plate process should read up some good handbook on the subject. The aim of these instructions is to explain only those operations which differ materially from the ordinary method of working.

Exceptional care must be taken to avoid dust spots and all abnormal markings on the plate, as these would show at once in the finished half-tone. Everything should be at hand ready when the exposure is finished, as the plate will have a tendency to dry during a long exposure, and no time must be lost in getting it developed. The developing solution must be poured on in such a way that it will immediately flow over the whole plate without hesitation. Any marks caused by stoppage of the flow will be fatal to a half-tone negative. As little as possible of the solution may be spilt from the plate, as we want all the silver solution we get retain to build up the image.

If the exposure is correct, the picture will come up brilliantly in a very short time, and then will slightly dull all over. It is no good prolonging the development beyond this stage. Pour off the developer, and examine the negative with a powerful focussing magnifier by transmitted light. The point to determine

is whether the dots in the high lights are joined or nearly joined in a sort of chessboard effect. If they are very wide apart the negative is under-exposed, and it is useless going further with it. Assuming that they are right, give the negative a rinse, and immerse in the cyanide solution until fixed. If left in too long the image will be attacked.

Even if the plate is intensified (redeveloped) before fixing, it will be necessary to intensify again after fixing. To do this rinse the plate thoroughly and proceed to apply the copper and silver intensifier, as described on page 241. Examine the negative with a magnifier, and if the dots in the high lights are not quite joined up at the corners (as in fig. 6), continue the washing for about five minutes, and then apply the copper bromide solution again, wash, and repeat the blackening. The dots should now be joined, unless it is a refractory case of under-exposure, or of the screen being placed too near. A third application of the intensifier may even be made, but before each subsequent application a weak solution of nitric acid must be applied and the plate washed.

The "cutting" solution is applied after the application of the iodine solution and before the final blackening with sulphide; it acts most vigorously on the edges of the dots, sharpening them up and making the negative such as will print better. It also reduces the size of the dots in the shadows, and thus secures a better gradation. In practice the action of the "cutting" solution is watched and stopped just at

the stage where the dots in the deepest shadows have disappeared, and those in the next lighter shade are the merest "pin points." The dots of the other tones will graduate up in size until in the highest lights they join up firmly corner to corner. If any break or want of density at the junction is shown, further intensification must be resorted to.

Between the extremes of openness and absolute closure, there are certain effects which are sought by some operators in order to accommodate the conditions of printing and etching. For instance, some etchers like what is termed a "fat" dot in the high lights, which will gradually be reduced in the etching. Others like a cross-line effect—a slight junction of the dots on the metal—so that it holds back the etching. In the same way variations in the shadow dots are demanded. Some etchers prefer large dots, but we think the majority like best very fine dots, so that the white dots which they form will stand a slight enlargement in the etching. The character of the negative must also be suited to the thickness and sensitiveness of the film on the metal.

It will be best for the beginner to aim at the "chess-board" formation in the high lights and "pin point" dot in the shadows. From this standard any desired variation can be made.

After the final washing, the plate is dried off with gentle heat, if hurriedly required, and may be printed from without varnishing. But it is better to varnish in order to prevent the film being scratched or otherwise abraded. This varnishing is very simply done by flowing the plate over whilst wet with gum solution.

Of course, if the film has to be stripped it must not be varnished.

When dry the plate is ready for printing. Some operators prefer to cut through the film a ruled border line to the picture, this being done with a sharp graver point pushed through the film with a cutting action, not dragged through the film, as the latter course would tear it.

Collodion Emulsion and Dry Plate Negatives.—All the conditions applying to wet plate negative making equally apply to collodion emulsion, and especially the precaution as to dust spots, which seem to affect more a moist emulsion film than a wet collodion one.

It is thought by some operators that the screen distance and stop should be somewhat less in the case of emulsion plates, either collodion or gelatine, owing to the tendency of the dot image to spread in the film. It is certainly more difficult to get sharp dots in emulsion plates; but whether this is due to the spreading action or the difficulty of "cutting" to the same extent as wet collodion it is hard to say. Halation has something to do with it, and there is, therefore, an advantage in backing dry plates.

Collodion emulsion negatives may be brought very near to wet plate quality as regards the dots, and they are possibly superior in respect to gradation. The same intensifying and cutting must be resorted to.

In the case of gelatine dry plates the exposure must be full to the extent of slight over-exposure, and the cutting done with ferricyanide solution. The best intensifier, in my opinion, for dry plate work is the

silver cyanide. The great difficulty in the case of dry plates is to keep the shadow dots small enough. Some operators do not attempt to get them very small, relying on the closing-up effect of printing to produce the requisite effect.

One difficulty must be looked for in wet plate and moist emulsion, viz., the accumulation of moisture on the screen due to dark room and studio being at a different temperature. This trouble is most frequent in the winter time. It may be overcome by rubbing a little glycerine or vaseline on the screen, and then polishing off; or by putting a hot brick, a hot water bottle, or an electric radiator inside the camera; or by warming the screen slightly. Another way is to coat the screen overnight with a weak gelatine solution made as follows:

Gelatine	¼ ounce	6.25 cc.
Acetic acid	I	„	25 cc.
Water	20 ounces	500 cc.

But the best way is to endeavour to keep the dark room and studio at the same temperature. This will obviate many other troubles.

In the hot summer time the plate will have a tendency to dry during long exposures. Experienced wet plate operators will call to mind such remedies as adding glycerine to the bath, which may be done under proper conditions. The beginner is warned to avoid such a remedy, as it is more than likely that he will spoil his bath. A simple way to prevent drying is to affix a pad of damp blotting paper to the back of the negative.

It is well when working under a skylight which allows the sun to beat on to the camera to stretch

a white cloth a little above the camera to reflect off the rays.

A good negative will have little contrast of the nature of ordinary negatives used for silver printing, that is to say, there will be no intense high lights and clear glass shadows when the negative is held at arm's length. There will be a dim slaty tint over the whole, no solid blacks being apparent, yet the picture showing the detail quite plainly, especially when viewed against a sheet of white paper. Examined with a glass the dots should be intensely black. There should be no stain on the negative, nor veil between the dots.

A word may be said, in conclusion, with regard to the practice of making an allowance in the screen distance for the class of subject. Many operators do this, but it is not certain whether it is really warranted if the screen distance, stop, and exposure are correct in other respects. Generally speaking, the rules for distancing the screen in respect to subject are :

- A. For subjects with little contrast, further away.
- B. For subjects with strong contrast, nearer to.

There must be, in any case, a dot in the deepest shadows, and if these are very dark coloured the high lights will be "bunged up," as the saying goes, before there is any shadow dot at all, should the high lights be at all bright. There is only a certain amount of contrast possible to render truthfully the picture by means of the screen. If detail is wanted contrast must be sacrificed ; if contrast is wanted detail must be sacrificed either in the shadows or high lights.

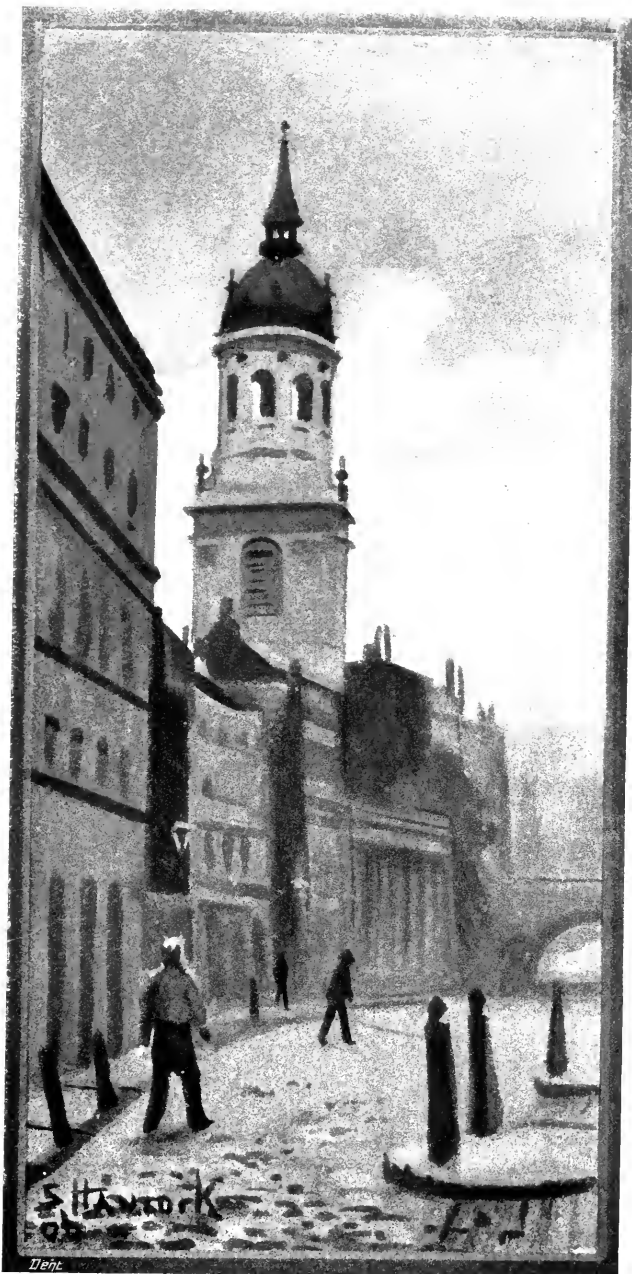

METZOGRAPH SCREEN BLOCK
BY A. E. DENT AND CO., LTD.,
7, BROADWAY, E.C.

Metzograph Screen.—With a medium fineness of grain the screen should be placed at the minimum distance. The main exposure should be made with $f/32$ or $f/45$, and a flash may be given at $f/64$ if the original is very strong in contrast. The negative should only be developed for sufficient time for the image to appear, and after fixing should appear as a network of lines in the high lights with clear spaces between. If the negative consists of a series of dots instead of lines the screen distance is incorrect and the result will be poor. The negative may be finished in the ordinary way. Copper intensification will improve the negatives for printing. Avoid making negatives too strong in contrast, and avoid over-development, which fills in the spaces between the grain in the high lights.

CHAPTER XIII.

PRINTING FROM THE NEGATIVE.

ALTHOUGH the “fish glue” or “enamel” process is now almost universally employed for printing the half-tone negative, there are occasions when some of the older processes are useful, and, moreover, a thorough grasp of these earlier processes is an aid to the better understanding of the “enamel” process. I therefore give the working instructions for the various well known processes.

The Albumen Process.—Take a piece of polished zinc plate, lay it upon the polishing board, and rub it, not too harshly, in the same direction as the original polish, with the very finest pumice powder, applied with a tuft of cotton-wool or piece of felt moistened with water.

Have ready an etching trough with a suitable quantity of the following solution in it :

Water	20 ounces	500 cc.
Powdered alum	$\frac{3}{4}$ ounce	18 grams
Nitric acid	1 dram	2 cc.

After polishing, give the plate a rinse, and immerse in the above solution, rocking until an even matt surface is attained. Rinse under the tap, and remove the scum with a tuft of cotton-wool.

Affix the plate to the whirler, rinse with water, and coat twice with the following solution, which must have been previously carefully filtered through a

piece of cotton-wool placed loosely in the neck of a funnel :

Dried albumen	200 grains	11 grams
Water	20 ounces	500 cc.
Potassium bichromate	200 grains	11 grams

The whites of two eggs may be used instead of dried albumen. In either case the albumen should be well beaten or shaken up. It is a good plan to put some broken glass in the bottle to assist the shaking, or use an egg beater. Dissolve the bichromate in 2 ounces of water and add to the egg solution, thus making up altogether about 20 ounces. Add liquor ammonia drop by drop until the solution turns from a reddish colour to a bright yellow. This will keep at least a week. The addition of 200 minims (12.5 cc.) of fish glue makes the image develop more easily.

The solution is poured on in a pool in the centre of the plate, and the first coating must be thrown off into the sink, as it will be too much diluted with the water on the plate. Coat again, then start the whirler, slowly at first, then quicker, for a few seconds. Detach the plate and dry carefully over the stove, allowing only a gentle heat to impinge on the plate, or the coating will be rendered insoluble. When the plate is fairly warm, blow upon it, and the moisture should then be driven off.

It is quite a common practice now to whirl the plate face downwards over a stove or hot plate, and it is thought that there is not so much risk of dust falling on it. The gas fumes do sometimes affect the coating, rendering it insoluble, and it is therefore generally better to remove from the whirler and dry over a

stove with coated side upwards. Care must be taken not to get the plate too hot. The heating must be stopped at the point where the moisture can be driven off by blowing on the plate.

When the plate has cooled down, lay it in the pressure frame upon the negative, after carefully dusting the latter with a broad camel-hair brush. It is a safe plan to warm the negative to the same degree as the zinc plate, then to adjust it on the zinc while held in the hand, and turn both over, laying them together in the printing frame. Screw the frame up tight, and if iridescent circles appear between the negative and the front glass of the frame, it may be judged that the pressure is right.

Expose to light, putting out at the same time an actinometer. When a certain number (found by experience) is attained, the zinc plate will be fully exposed. The exposure will be from three minutes in the sun to fifteen or twenty minutes in the shade. If electric light is used there is hardly need for the actinometer, as the time will be pretty constant with a given lamp. With a thirty ampère open arc working at its best the exposure will be three to four minutes, the frame being placed about eighteen inches away. With the enclosed arc the exposure will be less than half.

When it is judged that the exposure is complete, remove to the dark room, lay the plate on the rolling-up slab, and with a composition roller, ink the plate all over with a thin, even film of transfer ink, which should have been previously thinned down with rec-

tified turpentine and evenly distributed on the ink slab. The rolling of the plate should be commenced when the roller begins to make a sucking noise on the slab. It is important that the ink be not laid on too thickly, or there will be a tendency to smudge. The ink used may be either photo-transfer or lithographic retransfer "stone to stone" ink, either of which is bought ready for use. For the dragon's blood process a stiffer form of transfer ink, and one holding more wax, is used, known as "American etching ink."

The turpentine must be allowed to evaporate from the ink. Then immerse the plate in a dish of clean cold water, and with a piece of cotton-wool, well moistened, wipe the plate gently with a circular motion. If the negative has been of the right density, and the exposure has been right, the surplus ink will clear away readily, leaving the picture sharp, clear, and black. In case of under-exposure portions will wipe away, and with over-exposure it will be impossible to get the picture clear. If the excess of exposure is not too great, it will sometimes be found effective to add a little liquor ammonia to the washing water, or a few drops of potassium bichromate solution are often effective.

When the picture has been brought up clear on the zinc, rinse and fan the plate with a square of cardboard or other means until dry. Then dust on to the plate very finely powdered asphaltum, brushing out the surplus first with a soft bristle brush, and finally with a wad of cotton-wool or a powder puff. Hold the plate over the stove until the dull matt appearance

of the asphaltum turns to a glossy effect. When cool the plate is ready for the etcher.

Instead of asphaltum resin may be used, but it is not such a good acid resist. A still better powder which is very largely used is dragon's blood, a red powder which is brushed on the plate until the ink is well covered, and then heated until the red image turns a deep brown. Waxed asphaltum, which is used for photo-litho, is better than asphaltum alone, as the latter never really melts, and is apt to be granular as a covering. A mixture of resin, asphaltum, and pitch, sold under the name of Calmels' powder, is an excellent resist. Another "proprietary" article is Russell powder, which seems to be a mixture of very fine blacklead and French chalk. This requires a preliminary dusting with resin, and the latter is heated until tacky, upon which the Russell powder is rubbed well in with a tuft of cotton until the image shines like a blackleaded surface. The plate is then ready for etching, and really possesses a very strong resist.

The Blue Process.—A modified albumen process has been introduced and called the "blue" process, from the fact that the image, when developed, is of a blue colour, caused by the dye coating. The sensitive albumen solution consists of

Albumen	100 grains	5.5 grams
Ammonium bichromate ..	180 "	10 "
Water, distilled	20 ounces	500 cc.
Ammonia	5 to 6 drams	16.5 to 20 cc.

The plate is coated with this solution in the usual manner, and exposed about the same time as the usual albumen bichromate print. After exposure the plate is

flowed with the following solution :

Chloroform	3½ ounces	500 cc.
Benzole	6 drams	100 cc.
Alcohol	136 minims	40 cc.
Mastic	75 grains	25 grams
Aniline violet	75 ..	25 ..

When the solvents have fully evaporated from the coating the plate is developed in water with a tuft of cotton. Asphaltum may be used instead of mastic.

The plates will be somewhat more difficult to develop than the inked image, but the result is worth the trouble, as the dots are very sharp and stand etching without any other preparation.

The Bitumen Process.—This is the oldest of all printing processes, but it is now practically obsolete in northern climates owing to its slowness and uncertainty. In countries where there is plenty of sunshine it is still worked with success, but I do not consider it has any advantages over a good enamel print, except that zinc may be used instead of copper, because no burning-in has to be done. Bitumen is not easy to print by electric light. One advantage claimed for bitumen is that negative films (previously soaked in glycerine) may be squeegeed down on to it, and printed without a pressure frame. This, however, may be done with albumen or fish glue, by coating the plate, after sensitising, with vaseline or castor oil, applied with a roller as one would apply ink. A film squeegeed down will then stick perfectly without curling up.

Ordinary commercial bitumen is unsuitable in its natural state for printing purposes. It has to be

purified by washing with ether until all the least sensitive constituents are washed out. This is a tedious and expensive operation, very difficult to accomplish satisfactorily. It need not, therefore, be described, especially as purified bitumen can now be easily and cheaply obtained from dealers in materials for the half-tone process.*

The solvent usually employed is highly rectified benzole, though some workers prefer to use a mixture of benzole and chloroform. Chloroform is a most perfect solvent, but it evaporates too rapidly. The benzole must be perfectly free from water; even a wet bottle will sometimes spoil it. To prevent the benzole or other solvent evaporating too rapidly and the film becoming brittle, it is usual to add a few drops of oil of lavender. Others add a very small quantity of Venice turpentine; but care must be taken to avoid an excess, or the coating will stick to the negative. The theory of adding Venice turpentine is that the purification of the bitumen takes away the sticky properties, so that the film may become pulverulent if the purification is carried too far. The Venice turpentine is accordingly put in as an inert substitute to hold the film together in development. It is also said by some old workers that a few drops of oil of lemons will quicken the exposure.

The following is a good formula :

Finest powdered Syrian asphaltum	1½ ounces	40 grams
Chloroform	8 "	225 cc.
Anhydrous benzole	12 "	275 cc.
Venice turpentine	120 grains	7 grams
Oil of lemons (or lavender)	40 drops	2 cc.

* A method of making bitumen much more sensitive has been described by Prof. E. Valenta, "Process Year Book," 1910-11.

The solution should be filtered through cotton in a closed filter. By increasing the chloroform and benzole a thinner film will be obtained, which will print quicker.

The coating may be done with a whirler, but no time must be allowed for the solution to evaporate. The turning must be commenced without the slightest delay ; also the turning must not be too quick, or a star pattern will be formed on the plate.

Another way is to select a plate larger than required, pour a good flow of bitumen along the edge nearest to you, and then quickly allow it to run to the opposite edge by inclining it, and allowing it to run off into a trough whilst the plate is held perpendicular. Only the best part of the plate must be used with this method.

It is advisable to dust the negative with powdered talc (French chalk) to prevent it sticking to the bitumen.

The colour of a suitable bitumen coating will be a transparent golden tint. A very faint brown image is sometimes visible before development. The latter is accomplished with rectified turpentine, which is flowed over. If the print refuses to develop, it may be assisted with a piece of cotton-wool gently rubbed over it. The moment all the detail is visible under the scum of turps and washed-out bitumen, the plate must be placed under a strong rose tap until all the greasiness is washed away and the image shows sharp and clean. Some workers flow soapy water over the plate to assist in removing the greasiness. When clear, the water can be blotted off and the plate set up to dry.

If allowed to stand in the sun it will be strengthened. Then it is ready for the etcher.

Photo-litho Processes.—Either of the foregoing processes may be applied to lithography by flowing the sensitive coating on stone, thin zinc, or aluminium as used for lithographic work. The procedure is exactly the same, except that for stones or thin plates a turntable whirler must be used, or in the case of stone no whirler at all, relying on levelling to get an even coating. A specially deep printing frame must be used (such as fig. 73a), or the method of film printing used as given in the description of the bitumen process. For thin zinc or aluminium plates pneumatic printing frames are best. The image is usually dusted with finely powdered resin, this being melted in the case of stone by heating the surface with a blow-lamp. After a slight etching to clean up the work the usual lithographic rolling-up follows.

Paper transfers can be prepared according to the usual photo-litho transfer process. This method has the advantage of not requiring the use of reversed negatives and heavy pressure frames, but in other respects it cannot compete with direct printing on zinc, aluminium, or stone.

Suitable transfer papers for this purpose are manufactured by Jaffé, of Vienna, whose agents in England are Messrs. Penrose and Co.* The brand of paper used is known as "Eagle Brilliant." It is sensitised by immersion in the following solution :

Potassium bichromate	7 drams	22 grams
Water	20 ounces	500 cc.

* A ready sensitised photo-litho transfer paper called "Amphitype" has recently been introduced, and greatly simplifies the process, as the paper is ready sensitised.

The formula just mentioned is most suitable for winter time. In summer time the following is better :

Water	20 ounces	500 cc.
Potassium bichromate	$\frac{1}{2}$ ounce	12.5 grams
Manganese oxysulphate	30 grains	1.5 „

Either of these baths will keep for a fortnight, but it is advisable not to be too economical in their use, and the bath must by no means be exhausted. If it should show a brown discolouration it must not be used any more.

A sufficient amount of solution in the above proportion is made up, and liquor ammonia is added drop by drop until the solution is turned a light yellow. The temperature at which the solution is worked should be between 64° and 65° F. (18° to 19° C.) The paper is immersed film upwards in this bath for about four to five minutes until it is thoroughly soaked through, then drained, and dried by squeegeeing into contact with plate glass. Printing is done in diffused light, and on removal from the frame the print is inked up with photo-transfer ink thinned down with poppy or almond oil. The surface is inked all over with a very thin coating of ink, applied with a velvet roller, the ink having been previously distributed on a slab with a composition roller. Next immerse in a dish of cold water for fifteen minutes. Lay the print then on the rolling-up board or slab and pass the velvet roller over it again, when the ink will be picked up from the whites tolerably clean. Then go over the print with a damp sponge, wiping with a crosswise motion, until the whites are quite clear. The print can be inked up whilst moist by using a

velvet roller, and finally cleaned up with a wet tuft of cotton-wool. After inking, allow the print to dry spontaneously. Next dust over the surface with a powder composed of one part beeswax in ten parts asphaltum, melted together, and ground very finely. This can be purchased ready for use under the name of waxed asphaltum. Brush off the surplus with a soft brush, and finally with a wad of cotton. Then hold the print face down over a spirit lamp until the matt brown colour of the picture changes to a matt black. The print is then ready for transferring to zinc by the usual lithographic method.

The Enamel Process.—The method which is commonly known by this name has attained a remarkable popularity, and is now almost universally used throughout the world for printing half-tone negatives on to the metal. Although often called also the “fish glue process,” it is not strictly correct, as the enamel or enameline process when introduced did not involve the use of fish glue, and enamel processes are still worked which have no fish glue in their formulæ.

The principle of the process is that such bodies as gum, albumen, gelatine, glue, etc., in combination with a bichromate salt, are reduced and made insoluble in water by exposure to light; and further, if the metal plate bearing a film of one of these bodies is subjected to intense heat, the organic body forms an oxidation product which is insoluble in water and acids.

Gum was at first used for the process, but owing to its variable quality it requires care in selection to ensure uniform results. The finest picked white gum arabic

should only be used. Sugar in the form of sugar candy is sometimes added to make it less brittle and more adhesive to the metal.

Albumen is never used alone, but always in conjunction with the gum, glue, or gelatine. Either the fresh egg albumen or equivalent of dried albumen may be employed.

Gelatine differs so widely in quality that it is a very uncertain substance to use, and, moreover, it swells up on the plate, with also some tendency to spread. Its solution also sets when cold.

Fish glue has been found to possess the greatest advantages, and is the only substance that need be fully considered. It is always in a fluid condition,* and comes on the market as a fairly uniform product, especially if the clarified kind prepared for photo-engravers' use is purchased. It has a slightly brown oil-like colour and consistency in the clarified form. The unclarified is of a whitish opalescent nature, containing a chalky sediment.

I will first give a formula for glue alone, without the addition of albumen :

Le Page's clarified glue	10 ounces	250 cc.
Water	20 "	500 cc.
Ammonium bichromate	$\frac{1}{2}$ ounce	12.5 grams

Add liquor ammonia until a golden tint is reached.

To measure the glue, balance the mixing basin on scales and pour in the glue until the right weight is indicated. Dissolve the bichromate in the water and mix with the glue by vigorous stirring or with an egg beater. Filter through a piece of close-textured fairly

* A dried fish glue which only needs to be dissolved in hot water has recently been introduced, and seems to promise well.

thick felt, taking care to avoid air-bubbles by allowing the stalk of the funnel to touch against the side or bottom of the receiving vessel.

The mouth of the latter when not in use should be covered with a glass plate to avoid dust getting in. Dust and air-bubbles are amongst the most frequent causes of trouble to the beginner.

A variation of the above formula is to add chromic acid to increase the reducing action and produce greater insolubility and adhesiveness to the metal. It increases the sensitiveness of the coating. The negative must, however, be very good—sharp and opaque dots—when chromic acid is in the solution, or scumming will result.

Liquor ammonia is added for the purpose of neutralising the acidity, and thus making the glue keep better. A neutral solution prints quicker than an acid one.

A formula with these additions which has been tried with successful results is—

Water	8 ounces	250 cc.
Le Page's clarified glue	16	„	500 cc.
Ammonium bichromate	1 ounce		30 cc.
Chromic acid	80 grains		5 grams.
Liquor ammonia	20 minims		1 cc.

This will make a thick solution, but it will adhere tenaciously to the metal. The negatives must be of a perfect character to print well with this formula. Some workers prefer a proportion of 1 oz. glue to 3 oz. water, and $\frac{1}{2}$ grain of chromic acid per ounce of solution is thought sufficient.

It may be found that when printing with the enclosed arc lamp better results will be obtained with less bichromate, say one-third the above quantity.

The following may be taken as a typical formula containing albumen :

Albumen, dried 300 grains	15 grams
Water 10 ounces	250 cc.
Le Page's clarified fish glue ..	10 "	250 cc.
Ammonium bichromate ..	400 grains	20 grams
Chromic acid	120 "	6 "
Liquor ammonia	6 minims	.35 cc.

The albumen must be dissolved first in the water, a portion of the water being reserved for dissolving the bichromate and chromic acid. The albumen solution is added to the glue, weighed as before described, and well beaten. Then the bichromate solution is stirred in, and finally the liquor ammonia added. It will give the solution a slightly lighter yellow colour. The solution is filtered as already described.

It will print more slowly than the one last mentioned, and is more suitable for dry-plate negatives.

It may frequently occur that the liquid fish glue is a little thicker or thinner than usual, in which case the worker should add a little less or more than the formula or vary the amount of water. Occasionally, too, the glue may seem more soluble than usual under development, especially in hot weather. This may be corrected by having a solution of chrome alum at hand, made up of 80 grains of chrome alum in the ounce of water (5 grams in 30 cc.) and adding a few drops to the glue solution, with careful mixing, until the glue develops properly after the regular time of exposure.

The copper or zinc plate is first freed entirely from grease by scrubbing it with a soft nail-brush and pumice powder, or by polishing it with a tuft of cotton

charged with washed whiting, made into a paste with water and a few drops of ammonia. Be careful to clean the edges and back free from polishing powder. Coat as already described in the directions for albumen solution. The whirling should not be too fast, or a thin, streaky, and spotted film will result; nor should it be too slow, or the film will be too thick, and possibly uneven in thickness. The worker will get into a uniform speed of whirling by counting the number of turns of the handle of the whirler at a determined rate. About 240 turns per minute of the plate itself is probably as near an approximation to the speed as can be given. Of course, if the whirler is geared, the handle goes more slowly in proportion to the gearing.

When the whirling is finished, if it has been done over a stove, the film should be quite dry up to the edges, and of a transparent yellow colour, with glazed surface. Any dust spots or air-bubbles will be easily visible.

The plate and negative should be brought to an equal degree of heat and dryness, and placed in contact with each other in the printing frame, which is then screwed up with the usual pressure.

The exposure will be, as a rule, about twice as long as for an albumen print, and will register six tints on the Penrose actinometer.

On removal from the frame, the plate is placed in a dish of water to soak for one minute, and then given a good rinse under the tap, then a solution of methyl violet aniline dye is poured on. The proportion is not important, as the object is only to stain the

film, nor need violet dye be necessarily used. Any dye will do, but choice should be given to those which show up well on the metal plate, as the intention in using the dye is to enable the development of the image to be watched. If, however, the plate is not well developed before the dye is put on it is sometimes impossible to develop it properly after.

The following formula is a suitable one for the dye :

Methyl violet	1 ounce	25 cc.
Water	20 ounces	500 cc.
			or		
Eosine	1 ounce	25 cc.
Water	20 ounces	500 cc.

Dissolve the dye first in smallest possible quantity of methylated spirit before adding water.

The solution should be filtered if it has a curdled appearance or is full of undissolved particles.

After about a minute's immersion in the dye, the plate is put into a dish and water allowed to run over it in a gentle stream until the bare metal is visible between the dots. Some experience is necessary to determine when the development is complete, as a slight transparent film of glue is sometimes left if care is not taken to wash out thoroughly. A final rinse with warm water is effective for removing this last trace of glue. The plate is next drained and allowed to dry spontaneously, or it may be placed in a bath of methylated spirit, which absorbs the water and dries the image. The dye will probably have dissolved out by this, but having served its purpose it is now unimportant.

The next stage is the "burning-in." The plate, if small, is held in pincers ; or if large, is supported on

a grid over a gas stove with the flame in contact with the back of the plate and moved to and fro, so that the heat may not act too long in one place. The first effect will be that any traces of the dye will disappear, then the image will turn yellow, and gradually deepen to brown, and finally almost to a black. At the deep chocolate brown stage the heating is stopped, and the plate laid on a piece of asbestos to cool. It will be hot enough to burn wood, but it may be placed on a stone or slate slab.

Copper will stand almost unlimited heating, and the "burning-in" is usually carried to the stage where the bare copper assumes a rosy appearance, and then removed when the lights which were formerly a rose colour become beautifully silvery. Zinc must be heated more carefully and stopped at an earlier stage. Over-heating will speedily show on zinc by the metal assuming a crystallised appearance, the surface being covered with minute cracks. The metal will be very brittle when cool, and will snap with very slight bending. If the heating in the case of copper or zinc is carried to the black stage, the film will be burnt and will not stand the etching. Zinc requires a thicker film than copper.

The metal must not be suddenly cooled (as by plunging into cold water whilst it is hot) or the metal, if copper, will be softened or blistered.

Causes of failure will be unsuitable negatives, over or under-exposure, insufficient development, too much or too little heating.

Unsuitable negatives will be such as have the dots insufficiently joined up in the high lights and give a

cross-line appearance, dots being joined up on the metal; or, on the other hand, negatives which are too much joined up, and which print the dots too small on the metal so that they wash away. Again, there are negatives with too large dots in the shadows, thus yielding greyness in the shadows printed on the metal; the opposite effect will be quite transparent shadows on the negative with no dots at all, or only very weak ones. In this case the film seems to have a tendency to blister, lift, and wash off.

A "Cold" Enamel Process.—A good deal is heard from time to time concerning a mysterious "cold" enamel process, by which it is implied that the enamel requires no heating. The process seems to vary with each vendor of the "secret," so that it is impossible to say which is the veritable "cold" enamel. One puts forth the "blue" process already described as entitled to be called by this name, but this may be put out of court, as the majority of the "cold" enamels have a glue basis. Either fish glue or Cologne glue is bichromatised and printed in the usual way, but it is only moderately heated. The etching is then done in a bath which does not readily attack the film. This portion of the process we deal with in the chapter on etching.

The following formula for the printing solution is as good as any: 100 parts of Cologne glue are soaked in 600 parts of water for twelve hours and then melted on a water bath. To this are added 3 parts of dry albumen, dissolved in a little water. The mixture is

heated up to 212° F. for fifteen minutes. It should then be filtered and allowed to cool. Sixty parts of this solution should be mixed with 3.5 parts of dried albumen, previously dissolved in 30 parts of water, and then mixed with 30 parts of a ten per cent. solution of ammonium bichromate. The solution should be again filtered. This solution will keep in a cool dark room three or four days. The plate should be warmed before coating. The printing will take from forty-five to sixty seconds in the sun and five to eight minutes in the shade. Development is done with pure water exactly as for the fish glue process, and as a variation on the dye stuff Victoria green may be used. If it washes out in development immerse again in the dye after development, and then allow the plate to dry. The plate is then heated to the stage at which the dye disappears and the film becomes yellowish. When cool the plate is ready for its special etching process.

The Redcol Process.—This is a “cold” enamel process for zinc introduced by Penrose and Co. The method of working is as follows: Clean the zinc in the ordinary way with flour emery or fine pumice powder, then wash well under a water tap. Place the plate on the whirler and whirl dry, allowing the plate to get sufficiently warm so that you can just bear your hand to touch it; then pour on a pool of No. 1 or red solution in the middle, allowing just sufficient so that when whirled it will cover the plate. Immediately whirl rapidly in the sink or suitable place. This operation must be done quickly, as

everything depends on the quickness in getting a thin even coating, which should be very brilliant in appearance and should dry almost immediately with a high glaze. It must be perfectly dry before putting on No. 2. Now flow over No. 2 solution or second film, which should be whirled well over a stove, but must not be allowed to get hot. Also it may require to be assisted over the plate with a spill of paper or a string rod. When dry place on the negative and print in the ordinary manner ; time of printing about three minutes, but this depends on the light, which, if good, will allow of about two and a quarter minutes' exposure. When printed wash under water tap for about one minute and put in a bath of methyl violet as usual in the fish glue process. Wash the dye off and a faint image should now be seen. Now place on whirler and whirl over stove until dry, but the plate must not get hot. When cool, but dry, place in a dish of developer No. 3 for five to ten seconds. Lift it out and place under the tap, allowing a strong stream of water to flow from one end of the plate so as to wash away the dissolved red coating in an even wave. Rub very lightly with a tuft of cotton wool so as not to disturb the insoluble image, and examine the plate to see if it is quite free from the red coating ; if not, it may be dried and again developed in No. 3 solution for three to five seconds. Wash as described above, and then remove the insoluble fish glue image with cotton wool. The red film image remains, and cannot be removed except with methylated spirit or potash. When the plate is dry the process is complete

and it is ready for the etcher. No methylated spirit must be used in the process of etching, nor potash, but turps may be used for cleaning off any ink without injury to the image. The turpentine must be absorbed with sawdust.

The "Dry" Enamel Process.—There is one other process which must be mentioned which goes by the above name, and is also heavily charged with "secrets," so that one does not quite know which is the orthodox formula. All the "dry" methods are, however, alike in one respect, viz., that the sensitive film is made of a hygroscopic nature, and is dusted with a powder after exposure. The powder adheres to the film in the unexposed parts, showing the print brown on a white background. With a tuft of cotton, carefully handled, the powder will develop dark parts and give the operator a wide range to bring effect into the picture at this stage. By breathing, for instance, on a dark spot and applying the powder carefully, details can be brought out which no other method will do.

A formula for the sensitive solution is as follows :

Ammonium bichromate	..	250 grains	14 grams
Sugar candy	540 "	30 "
Chromic acid	160 "	8.5 "
Albumen, whites of two eggs.			
Liquor ammonia	240 minims	12.5 cc.
Water	20 ounces	500 cc.

Another formula is

Ammonium bichromate	..	1 $\frac{3}{4}$ ounces	11.5 grams
Sugar candy	2 $\frac{1}{2}$ "	62.5
Albumen, whites of sixteen eggs			250 cc.
Water	20 "	500 cc.

Still another is

Grape sugar	2 ounces	50 grams
Albumen	3 "	75 cc.
Distilled water	20 "	500 cc.
Ammonium bichromate	..	210	grains		11 grams
Chromic acid	120 "	6 25 "
Liquor ammonia .880	1	ounce	25 cc.

The albumen should be beaten up first, then the sugar, previously dissolved, should be stirred in, after which the ammonium bichromate, previously dissolved in part of the water, is added. The chromic acid should be dissolved first and the ammonia added to it, then the whole mixed gradually, whilst stirring, with the albumen. Some operators use dextrine in place of rock candy, and potassium bichromate instead of ammonium bichromate. After careful filtering, the plates are coated in the usual way on a whirler. Care must be taken to have the negative and plate quite warm, as the coating absorbs moisture from the atmosphere very readily, and the plate and negative may accordingly stick. A good preventive of this is to flow the negative with paraffin oil, draining off and absorbing the surplus thoroughly by means of a clean cloth pad; a coating of indiarubber solution is also effective. The exposure is from five to fifteen minutes by electric light.

The exposed plate is laid down to cool and absorb moisture in the unexposed parts. A tray of water with a litho stone standing inside it is a good thing to lay the plate in, resting on the stone. The tray should have a close-fitting cover. By leaving the plate a longer or shorter time in this tray the absorption of

moisture can be regulated. The powder consists of either stannate of soda, anhydrous carbonate of soda, calcined and powdered washing soda, or calcined carbonate of magnesia. The latter is the most reliable, and is not so harmful as the others if it gets up the nostrils or in the throat. These substances can be bought finely powdered, or may be made so in a mortar and sifted with a fine sieve. This powder is mopped over the print with a tuft of cotton, and will attach itself to the unexposed parts of the picture. With a soft powdering brush, such as that shown in fig. 104, the surplus powder is brushed off. The method of aiding development by breathing on the plate is not to be recommended, and must be done carefully or the plate may be easily spoilt. It is better to put the plate back into the tray and let it absorb more moisture. When the powdering is completed, which can be seen by the picture showing up against a light background, the plate is burned-in to a dark brown colour, and then put into a saturated solution of potassium bichromate, in which it should remain some minutes or until the coating in the unexposed parts comes off or loosens. From this solution put it in a ten per cent. bath of hydrochloric or sulphuric acid, and with a tuft of cotton the plate may be cleaned perfectly. It is then ready for the usual etching process.

Mr. Herman J. Schmidt is the most successful worker in this process, and has taught it largely in America and Europe. He keeps his methods secret, but it is known to the writer that after the burning-in

he puts the plate straightway into a tray of clean water, when the unexposed enamel comes off immediately. Any little remaining is cleaned off with table salt rubbed over with the finger whilst the plate is wet. Weak caustic potash solution will have the same effect.

There are no other printing processes of any importance. Carbon tissue transferred to the copper plate has been tried, but it is slower than the processes already described, and is not so reliable. Moreover, it is difficult to etch the plate.

Warnerke tissue, consisting of a gelatino-silver bromide or chloride film for transfer was also introduced some years ago, but did not succeed in becoming popular.

The Paynetype Process.—This method dispenses with the negative making and printing, a sensitised zinc plate being exposed direct in the camera. The zinc plates are sold ready prepared. They have been first coated with an acid-resisting varnish, and on top of this with a gelatino-bromide of silver emulsion. After exposure and development with pyro-soda, they are placed in a hardening bath of five per cent. bichromate solution. This tans the image so that it can be developed with hot water like a carbon print. The unexposed gelatine is thus washed completely away, leaving the resist varnish exposed. The result being negative, the exposed varnish is the image. This is next cleared away with methylated spirit, leaving the bare zinc. An ink-charged roller is now passed over the plate, and covers the whole plate,

which is next immersed in methylated spirit and developed like an albumen print with cotton wool. The final result is an ink image on the zinc. This can be strengthened by rolling up or dusting, and etched in the usual way. The process is only suitable for coarse screen half-tones such as are used for newspaper work. It is also used for line etching and photo-lithography.

Immediographic.—This is a process somewhat similar to Paynetype, the essential difference being that, instead of the plates being bought ready prepared, the operator has to coat the zinc himself, first with a substratum and then with a silver emulsion. The exposure and development are similar to Paynetype. The details of the process have not been published, but are being sold in Germany as a secret process.

CHAPTER XIV.

ETCHING THE PLATE.

IN all the methods of printing described in the last chapter we have left the plate at the stage where the etching begins. The procedure from this point will depend on the process from which the print was prepared.

Albumen Print on Zinc, rolled up with Transfer Ink and dusted with Asphaltum.—A very weak acid bath is prepared. A practical etcher would call it vinegar strength, and would judge it by tasting, but it may be taken as about 2 drams of nitric acid in 20 ounces (6 cc. in 500 cc.) of water. It is called a “passing” bath, and the plate is given two or three rocks in it, just sufficient to dull the surface. The slight scum formed by the etching is quickly wiped off under the tap by means of a brush or tuft of cotton-wool and the plate rinsed free from acid; then dried by slight heat and by fanning or blowing upon it. The object of this “pass” through the acid is to clean the surface. In this condition it will take any retouching better. If the ruled border line was not cut on the negative it should be ruled on the plate now with a mathematical ruling pen charged with either Lemer cier’s lithographic writing ink or with a solution of asphaltum in turpentine, and a little oil of lavender added to prevent it drying too

quickly. Some workers also add a little white wax. All the spotting, ruling, and other retouching is done with either of these inks, and the name of the engraver put in if a business block. Circular or elliptical border lines are also put in at this stage. Any portions of the work required to be quite white are scraped away, or any parts wanted in solid black are painted over.

The next step is to varnish the back of the plate with an acid resisting varnish, which is usually made up by dissolving shellac in spirit. Such a varnish may be bought ready for use, under the name of "Acid Resist" varnish. The margins of the plate within about half an inch of the border lines are also painted with this varnish. As it runs rather freely, care should be taken that it does not run into the work. It is a good plan to stand the plate up face to the wall on a narrow shelf when varnishing.

On the margin of the plate scrape away a broad line about half an inch in length. This exposes the zinc to the acid, which etches away a place where the depth of the etching may be tested by feeling with the thumb nail. This is called the "guide mark."

The plate is warmed and a little asphalt powder is brushed over the retouched parts. The surplus is brushed away carefully, and the plate again warmed to fix the powder.

Add 1 to 2 drams per pint (or 3 cc. to 6 cc. per 500 cc.) more acid to the bath used for "passing"—the strength being determined by the fineness of the work and the resistance of the film. The plate may now be put in the acid and etched until a percep-

tible depth can be felt in the guide mark. It is impossible to give a certain time for etching, owing to differences caused by temperature, the quality of the zinc, the purity of the acid, and the strength of the resist on the plate. It is not likely to be more than fifteen minutes. The work must be carefully watched, and if any tendency to over-etching is apparent, the plate must be quickly taken out and rinsed. It should be examined with a powerful magnifying glass to see if the dots are intact, and whether it has received sufficient depth. A proof taken at this stage will show whether a printable depth has been reached. In taking this proof it is a good plan to ink the plate with a rather soft composition roller, and somewhat thin ink, also laying a piece of printers' blanket over the two or three sheets of paper which form the press backing. If the plate will stand this "soft" impression it may be certain it will suit the average style of printing in the hands of the customer. The plate may then be regarded as finished, unless it is thought that "fine" etching is needful. This will be dealt with later on. If the plate is shallow further depth can be attained in the process of "fine" etching.

The nearest standard for the depth is to endeavour to make the latter equal to the width between the dots. In the case of coarse screens this would probably not be attained in one etching without danger of undercutting. The method of re-etching will be presently described.

The bath must be rocked all the time during the etching—a gentle rocking so as to move the acid solution to and fro over the plate. An etching brush

must be used to clear off the scum as it accumulates, but must not be too freely applied or the dots will probably be reduced in size and made ragged.

If dragon's blood, resin, or other powders are used instead of asphaltum, the procedure in etching will be the same, except that some may stand more etching than others.

Plates produced by the "Blue" Process.—The passing, retouching, etc., will be the same as in the foregoing, and the prints will stand an acid bath of from two to five per cent. in the first etching. Extra depth should be obtained by re-etching, as subsequently described. "Blue" prints are generally on zinc, so that it is unnecessary to refer to copper etching.

Bitumen Print on Zinc.—The plate will stand the "passing" bath the same as for albumen prints, but somewhat more care must be taken not to overdo this first "bite," or the bitumen will be robbed of its "grease" and will not roll up. Retouching and other preparations are done as before. The plate is warmed up to 120° or 160° F. (45° to 70° C.), and when cool etched in a two per cent. bath for one minute. Then it is rinsed, dried, and gummed, as for the rolling-up method. When the gum is dry, the plate is wiped with a sponge and damp rag, and rolled up with the best black chalk lithographic ink, applied as stiff as possible with a good nap roller. The resist is dusted with resin and heated, and the etching is then continued as far as it is possible to go, with the acid increased to three per cent.

Dragon's Blood Process.—For deep etching of very

coarse half-tone work, as for posters, and for etching line borders or half-tones, this process is an expeditious one, and saves the use of rollers. The image is printed by the albumen process, but it should be inked with a very stiff etching ink known as the American Etching Transfer Ink. It is given a surface dusting with dragon's blood, and warmed until the red image turns to a chocolate brown, then put through the "passing" bath, retouched, and otherwise prepared, and etched for three to five minutes in a five per cent. bath. The plate is then rinsed and dried, heated strongly, and brushed with the dragon's blood powder in one direction only. Suppose the sides of the plates are marked thus :

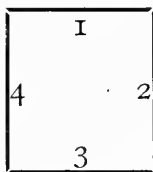

The first brushing should be from 1 to 3. The powder is thickly applied with a tuft of cotton-wool, and then the surplus dusted off by stroking the brush (fig. 104) in the direction indicated. By this means the powder is left lying against the side of the lines or dots, like drifted snow. The plate is heated to fix this powder, and when it has cooled down enough to avoid the powder sticking to the barè metal, another brushing is given in the direction 2 to 4. These operations are repeated for the remaining two ways. The plate will then stand very strong etching with ten per cent. or more acid, and if sufficient depth is

not then attained a further powdering four ways can be given and another etching.

Photo-lithographic Print Transferred to Zinc.—The preliminary operations are the same as for albumen prints. For the first etching warm the plate slightly to fix the image ; etch in a two per cent. bath for one minute. Dry the plate. Gum, and roll up with good lithographic ink or “starting” ink—stiffer than for line work—or with chalk lithographic ink, and then etch to the right depth. Dusting is done with resin to increase the “resist.”

Rolling-up Process.—This also is only used for very coarse half-tone or line work. The print is made as usual by the albumen process, and the inky image is dusted with very finely powdered resin, applied with brushes similar to those in the dragon’s blood process. The plate is slightly warmed, only just sufficient to fix the resin ; then the plate is given a “pass” through a weak acid bath. It is then rinsed and the scum wiped off. The water is blotted off and the plate fanned dry. Thick gum is smeared over the surface of the plate and allowed to dry. A good nap roller is charged with the soft etching ink, known as “starting” ink, used as stiff as possible. If too stiff when purchased it is thinned down with middle varnish, but great care must be taken not to make the ink too thin. Also there must not be too much on the roller. The gum is sponged off, and the plate wiped with a clean soft linen rag, damped but well wrung out. There must always be a thin smearing of damp gum on the plate during the inking. If one ounce of gallic acid is

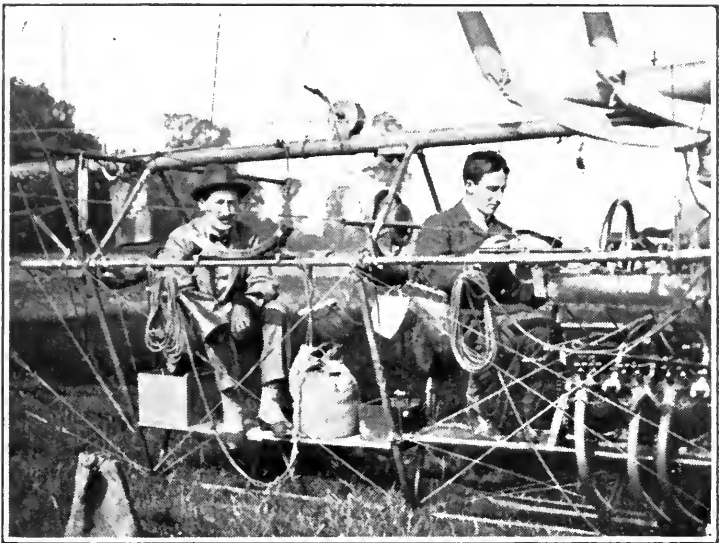

AN AVERAGE HALF-TONE
ON COPPER, WITHOUT FINE
ETCHING, FROM WET-PLATE
NEGATIVE, 100 LINE SCREEN

BLOCKS MADE BY
BRITISH PHOTO
ENGRAVING CO.,
COVENTRY. . .

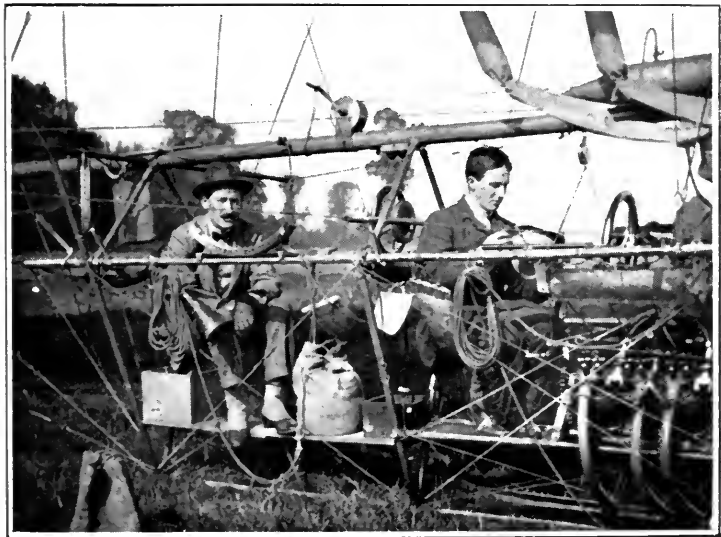

THE SAME WITH
125 LINE SCREEN



THE SAME WITH
150 LINE SCREEN.



THE SAME WITH
175 LINE SCREEN.

dissolved in a pint of water, and an ounce or two of this solution added to the gum, it will help to keep the ink from smearing the plate or filling up the work. When the picture is rolled up to good strength the plate is rinsed and sponged free from gum, and fanned dry. It is then dusted again carefully with the fine resin, but not warmed this time. The back and margins are painted with acid resist varnish, and it is ready for the first etching.

The Finishing Etch.—In the foregoing processes it is generally desirable to give a “finishing etch,” as it is termed, or re-etching. The resist is cleaned off with turps or paraffin in the case of ink, resinous or bituminous images, or with methylated spirit in the case of the “blue” and “dragon’s blood” processes. The plate is afterwards scrubbed clean and bright with caustic potash solution. A little whiting sprinkled on will give increased brightness to the plate. All dust or grit must be brushed out of it before the roller is applied. The glazed roller is charged with a thin even coating of “finishing” ink, and the plate rolled whilst it is as hot as the hand can easily bear. The effect of this rolling is to deposit ink only on the surface, without any tendency to cover the sides of the dots. When the image is nicely black the plate is warmed until the dull ink shines. On cooling, the etching can be renewed with a two per cent. bath for perhaps one or two minutes. This results in the dots being sharpened up, and any roughness in the depth of the plate smoothed down.

The Enamel Process on Zinc.—The plate, after being

burned-in and cooled, is retouched and varnished in the usual way. The etching is preferably done with a two and a half per cent. bath. Although this may prolong the etching, there is no risk of the film lifting or the edges of the dots etching ragged, and it will give, therefore, a much smoother, sweeter print than a plate etched quicker in stronger acid. Some etchers prefer to give a short "bite" with strong acid, say five per cent., believing that the etching can thus be completed before the film has time to soften. Whether the strength of the acid can be increased and the time of etching shortened will depend entirely on the printer; the etcher has little or no control. If the film blisters and leaves the plate the acid is too strong or the exposure of the print too short, or the burning-in not sufficient. If the film crumbles away in powder it has been over-burnt. The tendency of the film to be attacked may be prevented to some extent by adding to the etching bath 2 drams of chrome alum for 20 ounces (6 grams in 500 cc.) of bath solution. It is not desirable to give a finishing bath in the case of enamel plates, as the delicate sharpness of the dots is impaired, and the plate assumes quite a different appearance, wanting in the cleanliness which distinguishes the original image. "Fine etching," however, may be done as subsequently described.

Where the burning-in has been over-done on zinc, the etching will immediately show the crystalline structure into which the zinc has been broken up, and the proof will show the granularity of the plate.

It has been stated that this granular appearance

may be avoided by first immersing in a weak solution of chromic acid. If now the plate is put in the ordinary nitric acid bath the etching is very rapid. When the yellowish brown precipitate is wiped away the etched ground is seen to be quite smooth.

Another way which it is said will secure clean etching is to add "slimy" substances, such as gum, fish glue, dextrine, etc., to the nitric acid etching bath. Dr. Albert uses a mixture of powdered gum and alum to mix with the acid solution used in his etching machine. The effect is to retard the irregular action of the acid. If this mixture is used after the chromic acid bath mentioned above the effect will be to make the etching smooth and regular in the hollows.

Iron sulphate has also been suggested as a mordant for etching zinc, used in a strong solution, but its action is slow.

What is described as a "still" etching solution for zinc consists of

Sulphuric acid	6 ounces	150 cc.
Potassium nitrate	2 "	50 cc.
Water	20 "	500 cc.

Dissolve the potassium nitrate in the water, and then gradually add the acid until bubbling ceases. This bath need not be rocked.

Another etching solution for zinc which has a mild and a regular action is the following :

Nitric acid	13 ounces	325 cc.
Water	10 "	250 cc.
Sal ammoniac	2 "	50 grams
Pyroligneous acid (wood vinegar)				2 "	50 cc.

The constituents of this bath should stand two or three weeks in the open air after mixing.

Etching Plates prepared by the "Cold" Enamel Process.—There are several methods. One consists of adding formalin to the nitric acid bath, or immersing the plate previously in formalin. Another is based on making up a solution of iron perchloride in which the free acid is "killed" by the addition of hydrated iron oxide—prepared by adding liquor ammonia to a solution of iron perchloride. The hydrate is thus precipitated, and may be filtered out and washed free from ammonia, which may be ascertained by testing the droppings from the filter with red litmus paper. The hydrate is then added to the iron perchloride solution until it will dissolve no more, thus indicating when it is neutral. In this condition iron perchloride will etch zinc fairly well, and the iron solution will not attack the film.

Another method is to take 12 ounces (300 grams) of dry crystals of iron chloride and 2 ounces (50 grams) of dry zinc chloride, and rub the same down in a mortar with 20 ounces (500 cc.) of alcohol, specific gravity .810. When dissolved 160 minims (8.5 cc.) of nitric acid are added gradually. It will be seen that the solution is an alcoholic one, and that in itself will prevent the film being attacked whilst the other substances are etching the zinc.

It is not necessary to complicate the formula, however, as alcohol and nitric acid form as good a mordant as any for etching "cold" enamel. The etching fluid suitable for the Cologne glue formula described in the last chapter consists of 20 ounces (or 500 cc.) of forty per cent. alcohol and 2 drams

(or 6.25 cc.) pure nitric acid. For strongly printed plates the acid may be increased to six or seven per cent. If the shadow details do not come up the plate may be laid for from one to two minutes in a one to one and a half per cent. bath of water and nitric acid.

Etching Enamel Plates of Copper or Brass.—The etching solution for both these metals is iron perchloride. This is made by taking the solid perchloride,* which is in hard, yellow lumps, and dissolving it in hot water. About $1\frac{1}{2}$ lbs. of iron perchloride to one pint of water will bring the solution to the required strength ; but it is necessary that the solution should be tested with a Beaumé hydrometer, already illustrated and described (fig. 99), and should register 40° to 45° . The solution can also be bought ready made at a strength of 40° Beaumé. In practice it is found that 35° is an average strength suitable for etching, and the stock solution is diluted down to this. A solution at 30° or even 25° will etch the plate, but it is to be noted that the thinner the solution the stronger is its action on the film. Many etchers think that smoother and better results are obtained if the perchloride is used at 45° Beaumé. The solution is improved for immediate use by adding half a pint of an old bath to every quart of new. With a good quality of copper and a perfectly developed print the etching is a really simple operation, the plate having merely to be placed in the solution for a sufficient time. The trough need not be rocked, though some do so. If the etching is slow and there seems to be a deposit

* "Fersal" is a double recrystallised and purer form of perchloride recently introduced, and is well spoken of.

in the hollows to be etched, a gentle brushing may be done with an "atzpinsel" or other very soft brush. American copper etches clean, the copper being laid bare and having a pink colour, but some other kinds of copper have a heavy green deposit in etched parts. This result, however, is sometimes due to the etching solution being too old. When the plate is taken out for examination it should be well rinsed and brushed with a soft brush. Any mottled appearance which results may be disregarded.

Some etchers have great faith in etching the plate face down, holding it in wooden clamps (fig. 98), so that it is within about $\frac{1}{2}$ in. of the bottom of the dish. The plate should be slid into the solution at an angle of about 20° to the surface of the liquid, and moved to and fro, to make sure that there are no air-bubbles under it; then left for five or ten minutes to itself. The etching face down will proceed twice as quickly as in the face up method, and the etching is more even over the whole plate.

The time of etching will vary from five to fifteen minutes, according to the fineness of the work, the extent to which the plate has to be fine etched, and the state of the solution. Etching may be hastened by heating the solution to 100° F. (37° C.) It may also be considerably quickened by rocking the bath.

Brass is sometimes used in place of copper, and is also etched in iron perchloride solution of 40° to 45° Beaumé. Some kinds of brass containing a larger percentage of zinc may require a more dilute solution. Brass is not popular, however, as it takes longer to

etch ; the enamel does not adhere so well as to copper, and some think the result is not as good especially in vignettes, though etchers who regularly work brass claim they can get just as good results as on copper.

If a green scum is left on the copper after etching it may be removed by immersing the plate in the following bath :

Water	20 ounces	500 cc.
Chromic acid	1 dram	3 grams
Sulphuric acid	1 ,,	3 cc.

This is also sometimes used at the commencement of etching for cleaning up the plate.

Occasionally trouble will arise through a scum of glue covering what should be bare metal between the dots, and this will retard the etching for some time. The application of a potassium cyanide solution, about 1 ounce in 20 ounces (25 grams in 500 cc.) of water, will sometimes soften this scum and permit it to be washed away, or a very weak solution of iron perchloride applied to the warmed plate is effective.

Continual brushing of the plate during the etching is not to be recommended, as it tends to rub away the fringe of the dots, and gradually reduces them until they are etched away. Instead of brushing the plate before examination of the dots with a magnifier the solution can be drained off and the plate blown upon until the etching solution is forced aside and the copper may be plainly seen.

Wiping of the plate with a cloth is equally destructive to the enamel on the dots. The best way to dry the plate is to dab it with a chamois leather made into a pad.

“*Fine*” *Etching*.—This is also called re-etching, re-biting, and “staging” (American term). Its object is to force contrast. Some subjects require no “fine” etching if the previous operations are correctly carried out, yet there are practical workers who believe that every half-tone plate can be improved by this process.

Probably in a landscape the sky may be dull, or in a portrait the background may be so heavy in colour that it “kills” the portrait. In all cases the object of “fine” etching is to lighten; it is impossible to darken, except by burnishing, which will be described subsequently. But it is obvious that by increasing the brilliancy of the high lights we apparently increase the strength of the shadows by the force of contrast. “Fine” etching must be done by a man with some amount of artistic perception. The first step after the plate has been “deep” etched is to get a good proof, and compare this with the original.

Some powdered whiting or magnesia is rubbed into the plate with the ball of the finger and wiped off with the palm of the hand. If the print is in good dark brown enamel the effect can easily be judged.

The plate should be carefully compared with the copy. If it looks very dull it may be necessary to give it a light etching all over, as the “deep” etch has evidently not been carried far enough. Enamel prints should stand this re-etching without further preparation; but plates from which the resist has been removed require to be inked with the glazed roller and “finishing” ink as already described to give them a “top.” It may be advisable for this general



A. APPEARANCE OF PLATE AFTER FIRST ETCHING.



B. FINE PLATE FINE ETCHED AND TRIMMED-P.

etching to stop out one or two small parts, such as a high light which has already been etched as far as it will go, or a deep shadow which will become grey by further etching, owing to the tiny white points in the shadow being enlarged.

After this preliminary stage the shadows and most of the middle tones should be about right, and may be "stopped out," leaving the lighter half-tones, graduating to the high lights, to be dealt with. The plate is again filled in with whiting, and its effect studied. It will probably be found that a nearly white object against a light background hardly possesses sufficient contrast, so that it is almost impossible to tell where the white object ends and the background begins. If the original shows that the background is intended to be the darkest, that must be "stopped out" with varnish so that it cannot be any further etched. More or less fine sable brushes are used for the stopping out, and one must not attempt to be too detailed in the painting. We must adopt a style which painters would call "washy." There must be no clean, straight edges to the stopping, unless there are sharp edges in the original. Any lines, such as the rigging of ships, must be painted quite sharp. One must try to finish up near the boundaries of the shadows.

It is impossible to give any reliable rule as to the strength of bath and duration of etching. In using nitric acid the bath must not be more than about two per cent. For copper etching the usual perchloride bath may be used, or some etchers prefer equal parts of old and new baths, and the action of the etching de-

terminated by time. The period during which the plate is in the bath will be very short, as one, one and a half, two, two and a half, three, three and a half, or four minutes. The beginner will soon find that a half-minute makes a great difference to the result. Where the bath is rocked it is quite usual to time the etching by the number of rocks. Where work has to be stopped out in stages, about ten rocks may be safely given for a 150-line screen subject without showing markings at the edges of the stopping out.

Further "stopping out" and etching can be resorted to *ad libitum*, according to the fancy of the etcher, but excessive "fine" etching is to be avoided, as it may absolutely spoil the delicacy of the tones obtained photographically, and, moreover, make the block difficult to print.

Vignetting.—This is an extension of the principle of "fine" etching, and is a most difficult operation to perform successfully. The subject must in the first place be suitable for vignetting, and the operator should have made a negative in which the white margin surrounding the vignette is well closed up, so as to print fine dots on the metal. By the use of Holt's vignetter this effect may be secured during the negative making, even in the case of subjects which are somewhat dark at the margins. The printer must endeavour to make prints in which the dots will be fine yet strong. The deep etcher can do a good deal towards softening off the plate towards the edges by manipulation of the etching brush. By working it round and round the plate the etching is allowed to

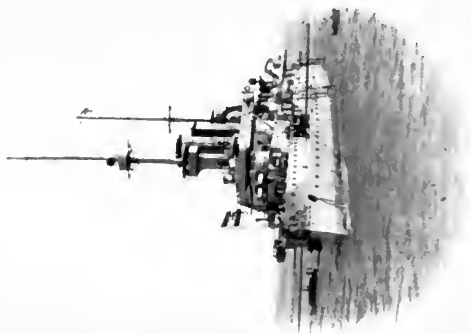

HALF-TONE, MADE WITH HOLI'S VIGSEFJER.

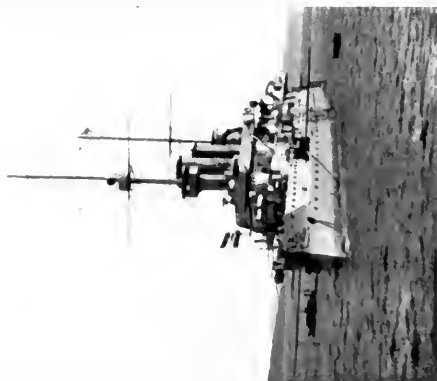

HALF-TONE MADE IN THE ORDINARY WAY.

go on more quickly in these portions owing to the oxide being removed. Care must be taken not to leave the dots too small and rotten, so that the fine etcher cannot deal with them.

The first step to be taken by the fine etcher when he gets a plate to be vignettted is to rub it in with white and mark out the extreme boundary of the vignette with a steel point. The margin outside this is stopped out with varnish, leaving a sharp edge, as it is a peculiar thing that the dots seem to etch quickest against a hard edge.

Starting from the centre the picture is entirely stopped out, to the point where the picture begins to vanish into the vignettted edge. This will probably be about three quarters of an inch from the scratched outline in the case of a cabinet portrait. Care must be taken not to leave a hard edge to the stopping-out varnish, and to avoid this a hog-hair brush, as used by painters, should be employed. The flat shape is best, and two or three sizes should be at hand. Taking up a brushful of varnish, it should be well worked on the blank edge of the plate until tacky, without any tendency to flow. Then, holding the brush vertical, use it as a dabber on the edge of the stopped-out centre of the picture, using less and less pressure as it approaches the boundary at which the etching is to stop. When the varnish is dry a one minute etching is given. The plate is then dabbed dry with the chamois leather pad, and the stopping-out extended about a quarter of an inch with the hog-hair brush, with perhaps a little touch of the ordinary stopping-

out brush to make a solid joining up. Another one minute bath is given; and again the stopping-out is advanced a quarter of an inch, and a further etching given. The part nearest the scratched outline will accordingly have reached the deepest etching, and will print the lightest.

A good plan in etching vignettes is to hold the plate in the hand and apply the etching solution with a sponge or mop, having the water tap handy so as to swill off quickly. The plate should be kept wet all over, and the mopping or brushing should be done from the outside edge, so that this gets most etching. The plate should be rinsed occasionally, and the dots examined to see how the etching is proceeding. This method gives much softer edges than the painting out, unless the latter is very skilfully done.

The whole of the varnish is cleaned off, the plate filled with white, and the "fine" etcher proceeds with his usual course of "fine" etching to improve the tones. He at the same time should lead them into the vignetting he has already done, so as to avoid a kind of high water mark all round the picture which is often seen in badly finished vignettes.

Stopping-out, especially for vignettes, is now often done with a special lithographic crayon. The "Excelsior" or the "Korn" brands are those used.

"Cut Out" or "Deep Etched" Half-tones.—In this case backgrounds and high lights are cut away, as well as vignetting and fine etching done to heighten contrast. This cutting out is best done before the fine etching and vignetting begins. A good deal of it may

be stopped out on the negative, and other portions scraped away before the first rough etching of the plate. The "fine" etcher has then only to work down to the cut out portions, softening his edges.

Some firms cut round the outline of the vignette with an electric engraving tool of similar style to a dental drill.

Where there are line borders on copper half-tones deep etching is sometimes done, as in linework on zinc, by rolling-up, and nitrous acid is used to hasten the etching. The plate is also well brushed. Such etching should be done out of doors or in a well-ventilated room, as the fumes are unhealthy.

A general hint applying to all cases of re-etching is that plates which have been inked and are greasy and dirty should be first thoroughly cleaned by brushing with a mixture of equal parts of alcohol and acetic acid; or sometimes acetic acid and common salt are used. This treatment is in case of copper only. Zinc can be cleaned with caustic potash and whiting, whilst the plate is hot.

A very fine wire scratch brush, as used by platers, is good for cleaning out the plates, and a plate polishing brush for getting out the whiting or magnesia.

It may fittingly be mentioned, in concluding this chapter, that "rough" or "deep" etching by hand is being superseded by machine etching, which is treated of in a later chapter. The action is very rapid and clean, and the "fine" etching required is lessened.

The author has seen the effect of wood-engraving produced on half-tones by working on the plate, before etching, with etching needles of various patterns.

CHAPTER XV.

MACHINE ETCHING.

SINCE about the year 1906 great progress has been made in half-tone work by the introduction of machine etching ; and although this has by no means

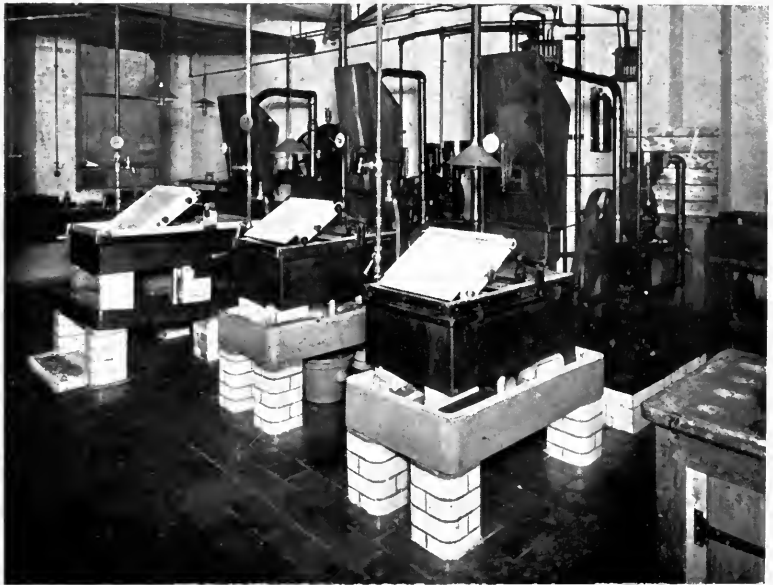

FIG. 157.

yet superseded the older process of tub or bath etching, it seems likely that it will eventually do so to a large extent.

The earliest invention in the direction of mechanical etching was the Levy acid blast, for which the first patent was taken out in 1899, and the machine was

soon afterwards put to practical use in America. The machine was first imported into England in 1906, being installed in the works of Messrs. J. Swain and Son, Ltd., who now have three of these machines in operation, as will be seen by the accompanying illustration of a portion of the etching room of this firm (fig. 157).

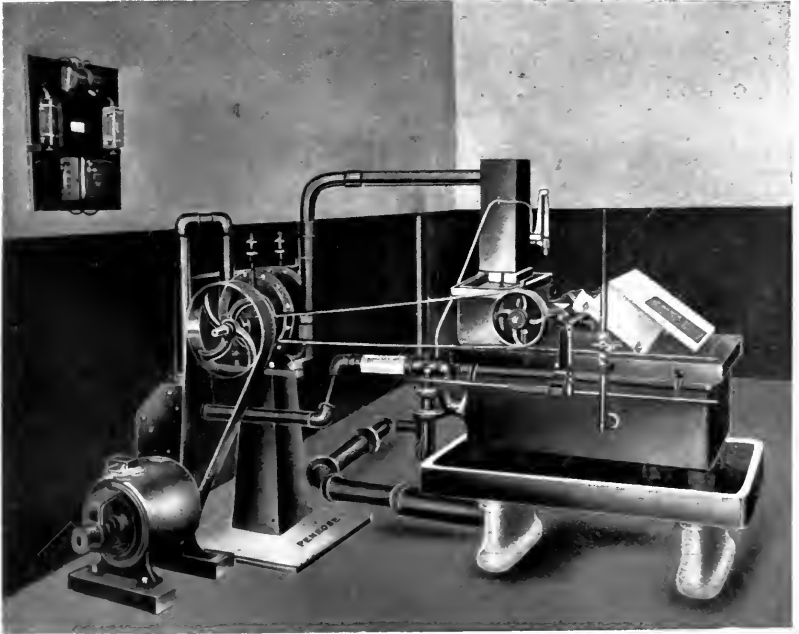

FIG. 158.

The machine is now used in a large number of process shops in England and on the Continent, as well as in America and other parts of the world, both for zinc and copper etching.

The general appearance and construction of the machine will be seen from the accompanying illustrations. Fig. 158 is a general view of the machine and fig. 159 a sectional diagram.

The principle of the machine consists in spraying the acid on to the plate by means of compressed air whilst it is held face downwards over the etching trough and rocked gently to and fro. The body of the machine consists of two stoneware compartments, one for etching and one for washing the plate. In the bottom of the etching compartment there are a large number of spraying nozzles communicating with a closed air chamber. These nozzles act as aspirators,

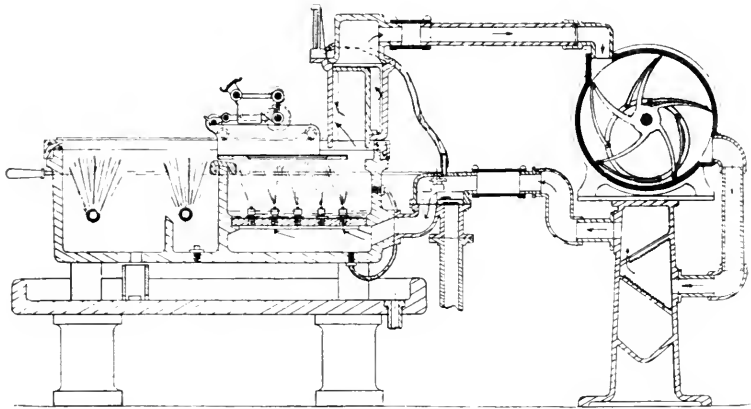

FIG. 159.

and when the air blast is turned on the acid solution lying at the bottom of the trough is sucked up and discharged with a strong impact in the form of a fine spray against the plate, the intensity being regulated by the pressure of the air blast. The plate being rocked to and fro the large drops of acid which accumulate are kept in motion and made to drop off when they become too large, whilst etching is equalised by this reciprocating motion. The fumes generated in

etching when the acid is strong are sucked out of the trough by means of the blower and returned as gases mixed with the air and etching solution to aid in etching the plate. The air being cooled by expansion after compression, together with the cool air blast, tends to prevent the acid becoming unduly heated, yet keeps it at such a temperature as will quicken its action. The air blast is regulated by means of a valve communicating with the open, allowing more or less of the air mixed with acid fumes to escape, instead of passing through the aspirators, and thus maintaining a constant circulation. The exact pressure obtained is registered in lbs. per square inch on a mercury gauge set up in front of the machine. The plate is clamped to a lid-like holder or tray running by means of grooved wheels on rails along the top of the trough. This allows the tray to be run in and out of the etching trough, and it is so balanced that it can be turned up for examination of the plate. When the plate has been etched it is pulled forward into the washing compartment and rinsed by means of a powerful spray of clean water. This, however, is only done in the case of zinc etching, as there would be too much waste of the somewhat expensive iron perchloride in copper etching. In the latter case, therefore, the machine is provided with a compartment for catching the drainings, so that they may be used over again. The plate-holder for copper etching is made of hard wood and ebonite, as the aluminium tray used for zinc would be speedily corroded and eaten away by the perchloride solution.

The blower used with the Levy machine is a rotary fan of special construction, and gives a maximum pressure of about $2\frac{1}{4}$ lbs., although not more than $\frac{1}{2}$ to $1\frac{1}{4}$ lbs. is used as a rule.

The interior of the blower is kept constantly lubricated with oil, so that the acid fumes or acid-charged air cannot attack the interior. To prevent any oil being thrown back into the etching chamber there is an oil trap, with baffle plates for catching the surplus oil, which may be used over again. Another feature of the machine is an earthenware flue chamber at the back of the machine, with baffle plates in it to stop and condense the moisture contained in the return blast. The acid is easily withdrawn from the machine by pulling out a plug, which allows the solution to drain off into the sink below. The lever for regulating the air blast is so arranged that the blast cannot be started until the plate-holder is in position over the etching chamber, and the holder cannot be removed until the air blast is shut off.

The machine is made in three sizes, No. 1 taking plates up to 16×13 in.; No. 2, 18×15 in.; and No. 3, 23×19 in. A number of small plates can be coupled together by means of aluminium clips.

The advantages of the machine are economy of time and of acid, together with a much better quality of work than can be performed by the old hand method. There is no undercutting of the lines, the shoulder sloping gradually from the top of the line to the lowest depth. The etcher can control the etching by time, by the strength of the air blast, and the

strength of the acid, and he can wash and examine the plate without taking it out of the machine. The improved character of the etching obtained by the acid blast is well evidenced by the accompanying photomicrographs from the section of a plate etched in the machine (fig. 160) and of a similar plate tub etched.

For zinc etching the acid used will be from five to ten per cent. strength, and etching will be complete as regards depth in about thirty seconds for a medium grain half-tone, the air pressure used being about $\frac{3}{4}$ lb.



FIG. 160.

For copper etching iron perchloride of the strength of 35° Beaumé is used, and an air pressure of $\frac{1}{2}$ to $\frac{3}{4}$ lb. Etching for depth will be complete in about two and a half minutes for a medium grain half-tone. It is usual to give the plate a bath of acetic acid and salt to remove scum before placing it in the machine.

Of course, further short etchings can be given after stopping-out for fine etching if required, but it is found that the amount of fine etching necessary is much less than in the case of hand-etched blocks, especially if the negatives have been made bright and full of contrast, so as to yield a print with the full range of tones. The machine-etching maintains what-

ever gradation there is in the print, not etching the shadows too grey and the high lights too light, as is the case with hand etching. Much less skill is therefore needed with the machine than with tub etching, though, of course, a skilful etcher can get the best results out of the machine.

The success of the Levy machine has led to other etching machines being put on the market for accom-

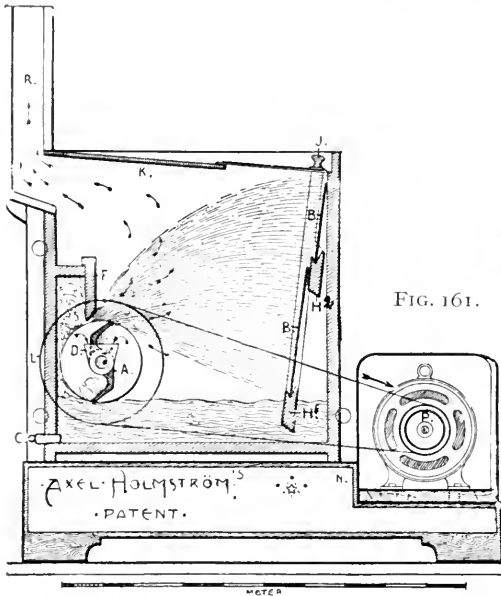

FIG. 161.

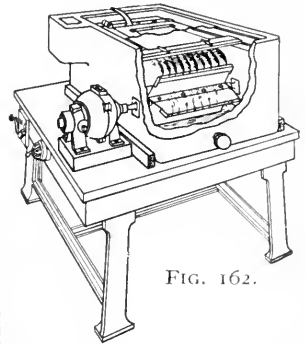

FIG. 162.

plishing the etching in various ways, but in all cases one principle is common, viz., the maintenance of the acid in a state of constant agitation, so that a constant supply of fresh acid replaces that in contact with the plate at any instant, and the products formed by the etching away of the metal are constantly removed, so that they can neither form a scum on the surface of the plate nor accumulate in a stagnant solution.

The machine of Axel Holmstrom (fig. 161) dashes the acid against the plate by means of paddle wheels, whilst the plate stands vertically and stationary in the trough of the machine.

The Mark Smith machine (fig. 162) acts in a similar way, but the plate is placed horizontally, face downwards, and remains stationary.



FIG. 163.

It seems reasonable to assume that in both these machines there will be a tendency to etch the plate more towards one edge than the other, the point of greatest impact being in a direction tangentially to the rotation of the paddle wheel, and in practice it is found necessary, with large plates, to turn them after half the etching has been accomplished.

The Albert etching machine (fig. 163) is quite different in principle. The plate is laid face up in the bottom of the trough, and a sort of rake or comb

dips into the trough close to the plate. The rake is given a rapid reciprocating motion, which has the effect of agitating the etching solution, so as constantly to free the plate from scum. The inventor recommends for use with the machine what he terms a "frothing powder," which appears to consist of finely powdered alum and gum. A proportion of

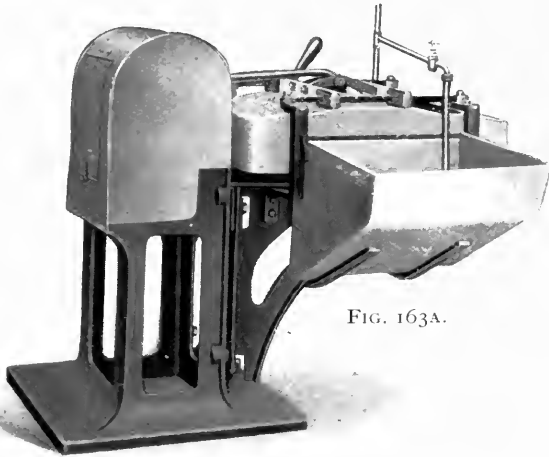

FIG. 163A.

3 parts gum arabic and 4 parts alum is suggested as suitable. A drawback to this machine is the excessive wear and tear of its mechanical parts. Fig. 163a is a new model of etching machine recently introduced by Albert.

The Danesi machine (fig. 164) rains down the acid on to the plate lying face up in the trough. As fast as the acid is deposited in the trough it is pumped up into the reservoir at the top, perforated on its underside with innumerable tiny holes. The plate has no motion, and the acid always falls upon the surface

of the plate with the same intensity of impact. Thus the duration of etching can only be controlled by varying the strength of the acid.

The "Pio" etching machine is similar in principle to the Levy in so far as it discharges the acid by jets operating against the plate held face downwards, but

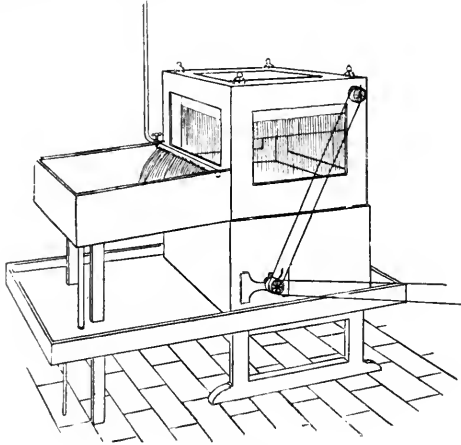

FIG. 164.

instead of the air and acid issuing from the jets, acid only is forced through under pressure applied to the surface of the acid in a closed chamber. The plate has no motion.

The Holt machine (fig. 165) proceeds somewhat on the principle of the Albert machine, except that, instead of the reciprocating motion, there is a rotary motion of the part which agitates the solution. Essentially the machine consists of a shallow trough, in the bottom of which is a board for supporting the plates. This board rises above the surface of the liquid when the machine is open. When closed the

top of the trough is covered by lids except a small opening through which the spindle of the paddle disc operates. The latter has on its under surface a series of blades, which swirl the acid about in different directions, keeping it in a constant state of agitation



FIG. 165.

as the disc is rotated. The trough is also given a simultaneous lateral motion to and fro to equalise the etching.

The foregoing comprise all the etching machines on the market at the time of publication of the present edition of this work, though various other forms of machines or modifications of existing ones

have been suggested or patented. A considerable amount of ingenuity has been expended on this subject, and the practice of machine etching in some form or other has now become well established. The advantage of machine-etched plates is that, being deeper and more smoothly etched, they print better, require much less making-ready on the printing machine, and the blocks are more suitable for duplication by electrotyping and stereotyping methods.

CHAPTER XVI.

FINISHING AND MOUNTING.

WHEN the plate leaves the hands of the etcher and fine etcher there may be some work to be done on it by the engraver, who, if skilful in metal engraving, can greatly enhance the result.

The simplest case will be that of taking out spots between the dots. This is generally done with a thin graver known as a "knife edge graver."

To fill up a white spot or repair a scratch is not so easy, but it can be done by forcing up the metal round it by means of a sharp pointed punch inserted between the dots, or punching the plate from the back, after marking the position of the faulty place by callipers on the back. The raised metal is then levelled down by scraping and burnishing.

The engraver often cuts a white line inside the black outline made on the plate before etching. He also rules or trims up and white lines any circles, ovals, or other borders.

His duty is also to cut the imprint, though this has been superseded to a great extent by impressing it with a sharp punch. It is sometimes advisable, even in this case, to trim and sharpen it up with the graver.

In the case of vignettted and cut-out work which has to be cut out on the routing machine, the engraver usually goes round the part to be routed with a

“scorper” (a round backed graver) forming a channel for the router to work up to.

Of late some firms have used for going round the work—especially such subjects as fashion plates—a dentist’s drill, consisting of a small electric motor with a flexible shaft attached to its spindle. At the end of the shaft is a holder for tools of various shapes and sizes. This holder is held in the hand somewhat like a pen, and guided round the work. It requires some practice to get into the way of holding the tool steady.

The edges of vignettes are often made to print lighter by entering the white lines between the rows of dots with a “tint” graver, and thus reducing the dots. Sometimes alternate rows of dots are removed, and in the case of very fine screen work, as 175 lines to the inch, white lines may be cut with the “tint” graver at an angle of 45° to the lines of the screen, the spacing being made coarse, say 90 to 100 lines to the inch. It is a mistake to try to imitate the ruling of the screen when cutting white lines. Blocks from artists’ wash drawings are sometimes elaborately worked over with the graver, until the result resembles a wood engraving.

“Cut out” catalogue illustrations can often be greatly improved by putting in high lights with the graver, and trimming up with the scorper any rough edges left by the fine etcher.

“Many-liner” gravers are very useful for softening edges. These are gravers making a number of lines at one cut. They are to be had in a great many degrees of fineness, and with a varying number of lines on them.

In the case of views, machinery subjects, etc., the sky in the former case, or the background in the latter, may be stopped out before any etching is done, so that when the proof is taken the parts print black. The plate can then be handed to the engraver, and the usual engraving effects put in, either by hand or with an engraving machine. A plate may also be stopped out in parts before etching, and afterwards these parts laid bare, whilst the etched parts are stopped out, the plate being put into a dusting box, such as is used for the photogravure process, and a grain deposited. The plate is then again etched. In the same way tints from stippled or ruled plates or shading mediums can be transferred. Or by some careful system of registration different parts of a plate could be printed with negatives having a grain of different degrees of coarseness or pattern, the plate being resensitised each time.

Besides engraving, a great deal may be done by means of the burnisher and roulette. These tools have already been described.

To use the burnisher it is rubbed on a piece of hard yellow soap, then held near the point between the thumb and first finger, the handle being under the hand, not as in holding a pen. The flat part of the blade is then rubbed on the part to be burnished until the same is bright, using a sufficient pressure, but not so much as to make hollows in the copper. This kind of burnishing is done with a blunt-ended tool, and covers fairly large spaces which it is desired to darken, or it follows any repair work where the surface has been

injured. Finer pointed burnishers are to be had in great variety, and are held like a pencil or crayon, being used for working up fine detail. In all cases it is to be remembered that rubbing down high-light dots darkens them, whilst rubbing down shadows closes up the white dots, and thus makes the shadows print blacker. Any part of the metal which has become roughened or corroded will print solid if burnished. The enamel must be removed before burnishing.

Rouletting is the exact opposite of burnishing. Its effect is that of lightening any dark parts. For instance, the shadows of the draping of a dress may be too dark and harsh. Then by applying the roulette the dark part is stippled with white dots. It requires considerable practice to acquire the knack of applying a roulette with flat face, so that it makes all the dots the same depth and size ; also to avoid slipping and scratching the plate. The roulette should be chosen something like the same grade as the screen. Single row or spur roulettes may be used against a straight edge for making dotted lines. There are also broad roulettes cut with lines instead of dots, and these may be run round the edges of vignettes. Roulettes are held the same way as burnishers, already described, or sometimes with the handle of the roulette between the first and second fingers.

It is generally desirable lightly to burnish over any work that has been rouletted or engraved in order to remove any burr thrown up.

Lightening up of high light tints can be done by running between the dots with a knife graver. In

America they use what is known as a "draw tool," with a hooked blade, or consisting of a holder in which a graver can be fixed at a suitable angle for drawing towards the engraver instead of the usual way of pushing it forward. What is called a "hook tool" can be had for the same purpose. Multiple liners made to match screen rulings are also made on the same principle as the "draw tool."

The plate is always filled with white before any tool work is done on it ; and, further, white is rubbed in as the cutting proceeds, so as to get an idea of the effect. Any delicate touches of the graver should be done under a magnifying glass of about 2in. focus, and the effect further examined with a higher power.

The bevelling or routing is the next stage. We have already described the bevel plane, and also the bevelling machine and router.

If the plate is a straight-sided one with rules, there is nothing to be done but to bevel up to the rule. With the shoot plane the chief thing to attend to is the sharpness of the cutter, especially the angle which makes the double cut to form the bevel and its shoulder. One should not attempt to cut too much at once or the forward end of the cut will be too deep, and the cut may be wavy. It is very probable that in trying to trim up to the rule in this case the latter will be cut away unevenly. The cutter should be set so that the full length of the cut may be taken at one thrust of the plane. Zinc is easy to cut, but copper will require more exertion for the same depth. The tool should be slightly more acute than for zinc.

A little paraffin assists cutting in case of zinc, and oil or soapy water for copper.

With the bevelling machine the only care needed is to keep the cutters sharp, and ground at the right angle. A gauge can be obtained to show this. The same cutters do for either zinc or copper, but cutters for zinc should have the point slightly "backed off" compared with the acute point used for copper. That is to say, after the usual angle has been ground the cutter is turned over and slightly rubbed down at an obtuse angle on the opposite side on an oilstone. The use of the lining beveller can be best explained alongside the machine by the maker's representative. The cutters must be kept exceptionally keen edged to do neat work, and one must learn first of all the direction of the various screw adjustments, getting them all into line with their micrometer scales at zero; then it is quite easy to work forward and back again. The greatest skill is required in stopping the cutter at the corners of the rules. Some workers will not attempt going very close, preferring to finish the corner with a graver. The work can be better seen if the plate is filled in with white. It is necessary to have an incandescent electric lamp close to the work, and a piece of mirror is also an aid in seeing the progress of a cut, the reflection being viewed instead of the original plate.

Messrs. Royle and Sons have introduced a little appliance called a "bench liner" (fig. 123), for making the rules round half-tones instead of doing it on the lining beveller. The argument in favour of this appliance is that the work can be done better in the

fine etchers' room than amid the noise and vibration of the machine room, and it leaves the machine free for bevelling pure and simple.

The routing machine is very simple to work, but its success depends entirely on knowing how to sharpen the cutters. They only need to be sharpened on the end facet. The sides must not be touched. Different cutters are used for zinc and copper; for the latter metal they are fluted. The cutter should be brought gradually down to the plate, or it will be snapped off if forced to make its full depth of cut at first contact. The cut is usually made about half-way through the metal, but for line subjects and cut-out half-tones the cutter is sometimes allowed to go through, so as to cut out the picture instead of using a fret saw. In this case the plate is tacked down to a block of wood before routing, or a piece of cardboard is placed under it. For trimming round a vignette or "cut-out" the plate is tacked on a piece of mounting wood and the cut taken right through.* The cutter should always be moved to the right and forward towards the operator; if pushed in the opposite direction it will not cut so well. Small size cutters should be used for working in narrow spaces and following intricate lines. If the cutter throws up a burr one of two things is evident—either the cutter is not properly sharpened, or the machine is not running at its right speed, which is usually 15,000 r.p.m., though it has now become the practice in America to run at 20,000 r.p.m., owing to the small

* Penroses have introduced what are called "piercing clamps," which support the plate about half an inch above the level of the bed, and thus permit of the cutter going through.

cutters (such as $\frac{1}{32}$ in.) now being used, these allowing a greater peripheral speed on account of their small diameter. The router head needs very careful and regular oiling with a thin but good oil, and the belts must be kept in good tension.

In the case of all machine cutters it is best that they come into contact with the grindstone as seldom as possible. An emery wheel is better than a grindstone. Only in case a point is broken off should the cutter be ground. A good oilstone should be sufficient to keep them in order for a long time. If very blunt or rounded off a quicker cutting may be obtained by rubbing them on to a piece of zinc or copper covered with emery powder and oil. It is a good plan to keep a new cutter always at hand for comparison.

In many shops it is customary to take proofs after the bevelling and routing, the plate being laid on an iron block on the bed of the press to bring it up to type height. In this way a perfectly solid and true backing is assured, and if thought desirable the waste margin outside the bevel or routed edge may be left on to act as a bearer to keep the pressure from being too heavy at the edge. This is especially useful in the case of vignettted or "cut-out" work. A further advantage of proving before the plate is put on the wood mount is that the latter can then be sent out to the customer quite neat and clean, instead of being stained with ink and turpentine, as it probably would be if the proof were taken with, it attached to the plate.

A separate chapter is devoted to proving. We will now follow the block through the final stage of mounting.

Before being fixed on the wood mount it is often the practice with vignettted plates to underlay them or to chamfer the edges down on a vignetting machine (fig. 147), which is somewhat like a circular saw, with the teeth barely projecting above the table. The plate is slid about over the cutter until thinned down, and the edges are then beaten over with a fibre mallet.

The margins of the plate, if left on are trimmed off with the circular saw or guillotine, and the nail holes made with a sharp-pointed steel punch on the lead punching block. The holes are then countersunk with the hand drill, and the plate placed in position on the wood block with a try square, applied to a straight side of the wood, and to any vertical or horizontal line on the picture. The mounting nails are then driven in about half-way with the hammer. When all are inserted the nail guider (fig. 134) or the flat-ended punch is applied to them and each driven home.

Lately an automatic nailing machine has been introduced, and is used by several large firms ; it drills the hole for the nails and then feeds down a nail and punches it home. Punching machines can also be had.

The block is next trimmed off near to the margins with the circular saw, and the sides squared-up on the shoot-plane or the trimmer. The end grain should always be shot first, so that a sharp corner is left when the lengthwise cut is made. Those who have handled shoot-planes and trimmers know how difficult it is to avoid the corners breaking if the ends are shot last.

There are two forms of trimmer. In the American form the cutter head and the tools are quite small,

whilst the bed holding the block is pushed past the revolving cutter head. The speed of the spindle is about 4,000 r.p.m., and the knives are set so that they just skim the edge of the table.

The other form is known as the "Bowler" (fig. 143), and is very popular in England. It consists of a large disc in which there are two broad cutters like carpenters' plane irons. The block to be trimmed is simply pushed up against the side fence and against the disc. The size of the disc has to be proportioned to the size of the block. The speed of the spindle is about 350 r.p.m.

The block must now be tried with the type-high gauge (figs. 147a and 147b), and if too high taken down with the rotary planer (figs. 144 and 145). If this machine is not available a long plane something like a carpenter's trying plane is used, on a bed which has type-high supports for the plane fore and aft of the block to be planed, so that when the right height has been obtained the plane can take no more off, as it then rests on the end blocks (fig. 146). If the block is too low, which it never should be, the only remedy will be to take the plate off and place a sheet of paper or cardboard between the plate and mount, though the usual practice is to leave the printer to paste an underlay on the bottom of the mount.

In America it is the practice of some shops to have a sand papering machine to smooth off the back and edges of the block.

The photo-engraver who wishes to secure the friendship of the letterpress printer should see that his blocks are well mounted. It has been suggested that the

plate should be mounted by gluing it, or by cementing it to the block, but though this will do well enough for the hand press it will not be safe for machine printing.

In some cases plates have to be cut close to the outline for mortising into a design. In this case there is no room for nails, and soldering is not always convenient or neat. Resort is accordingly made to a system known as "anchoring." The principle will be grasped by referring to fig. 166. The head of the screw is tinned and soldered to the back of the plate.

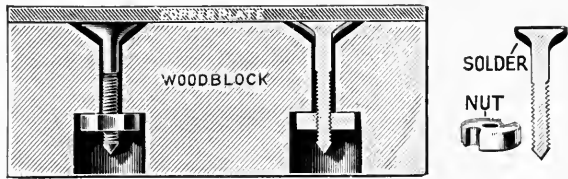

FIG. 166.

A special drill is used to make the shouldered hole in the wood block, and a key or small pliers is used to turn the nut which draws the plate tight up to the block.

A word must be said about "laminated" backing. This consists of mounting wood made up of several layers with the grain crossed and cemented together under great pressure. This forms excellent mounting wood which does not warp, though the top or bottom layer is apt to curl up if it gets wet. It is, of course, much dearer than the usual oak, mahogany, etc.

Type metal mounts are sometimes required, but the photo-engraver generally transfers that part of his order to the nearest electrotyper, who solders the plate on to the metal backing, or pins it with short brads

It has been suggested that etched zinc plates should be given an electrolytic coating of copper, brass, or nickel, so as to render them less liable to corrosion. This plan is quite practicable, and has several times been tried, but the trouble of working an additional process, and the fact that the customer would hardly care to pay anything extra for it, has deterred most photo-engravers from undertaking this further duty. Brass and nickel would have to be deposited with a battery. This does not involve a very expensive outfit, but it requires some time and care, together with experience, to get a good coating.

A superficial coating of copper may be applied to zinc plates by neutralising copper sulphate with a strong alkali, such as ammonia or cyanide. The plate is well washed and scrubbed with caustic potash and whiting, and is then immersed in this solution for a few minutes, when it will be found coated with a sufficient covering of copper. Copper plates may be made to look very presentable by immersing in a solution of cyanide and silver. A cyanide fixing bath which has been in use for some time for plates will do very well. A solution is sold called "Nickeline," which is readily applied to the copper plate, and with a little more trouble to zinc, without using a battery. "Galvanit" is another preparation recently introduced. It is in the form of a powder, which is mixed with a little water and rubbed on the surface of the plate, which then takes on a bright coating of nickel, tin, cadmium, silver, or whatever metallic powder is used.

CHAPTER XVII.

PROOFING THE PLATES.

THE first step in proceeding to take a proof from the plate is to brush it well out with turpentine and dab it clean and dry with a fluffless rag. The back should also be cleaned free from varnish and wiped, care being taken that there is no grit underneath when placed on the press.

The ink should be as stiff as it can be worked and well distributed with a hard and slightly tacky composition roller. A good black with a slight trace of blue in it is the best for yielding a good commercial proof. It must be applied to the ordinary block with frequent rolling in every direction until the shadows look solid.

The paper should be of the coated and calendered kind, with an almost equally good surface on both sides, and at least 60 lbs. weight per ream in royal size (25in. × 20in.) “Dull chromo enamel” is a kind much preferred by English photo-engravers. There will always be one side of the paper slightly better than the other, the worst showing the wire markings. The paper should be laid out or hung up in special racks to absorb a little moisture from the atmosphere, making it take the ink better, and giving it more flexibility, which ensures freedom from slurring. About three sheets of stout smooth

paper should be laid on top of the proof sheet, and the whole backed with a sheet of glazed pressboard or smooth cardboard. Some provers use a piece of fine printers' blanket and others thick indiarubber sheeting. A sheet of fine surgical rubber is sometimes used as a backing for large proofs, and is found effective. If the impression is not even and strong the ink will be left on the plate in mottled patches, and the proof will be grey and patchy. It is good to let the pressure "dwell" on the plate for a few seconds to give the ink time to absorb into the paper.

Vignetted plates are often difficult to proof with a clean edge. Some engravers circumvent this difficulty by applying powdered chalk to the vignetted edge with a fine brush or with the tip of the finger, after the plate has been inked.

A plate having very heavy shadows and great contrast sometimes needs underlaying. This is done by cutting out corresponding parts from a proof and attaching them to the back of the plate in the proper position. In some cases two or three thicknesses may be required, in which case each layer should be made a little smaller and the edge scraped down so as to taper off, or the underlay may cause a kink in the plate which it will be difficult to straighten out again.

The tapered underlay is especially necessary in proving vignettes, which must be built up so that the surface is slightly convex, with the highest point corresponding to the darkest part of the picture. It is also necessary to supplement the effect with a convex overlay similarly built up of layers tapered off at the

edges. This overlay is mounted on a stiff sheet of paper or cardboard the same size as the proof paper, and some means adopted for registering it in position in relation to the plate, which must be laid to marks on the bed plate, and if the press has a tympan the overlay should be pasted on it. Otherwise a makeshift will be to paste strips of cardboard with drawing pins stuck through heads downwards on the bed plate alongside the etched plate to act as registering points. A still easier way of registering often used in proving three-colour work is to have two long sewing needles stuck in short lengths of cane, and to have two small holes in the margin of the plate to be proved. A proof taken on the overlay sheet will show the position of these holes, and the needles can be stuck through at these points. The overlay sheet and proof sheet together can be lifted by means of the needles and placed in position by inserting the points of the needles in the holes in the plate. Not only vignette overlays, but the usual make-ready overlays may be applied by this means.

Some firms adopt the plan of sending the overlay with the block, so that the printer may have no further trouble in preparing it.

Various methods of preparing overlays for half-tone blocks have been suggested, and some have been patented, but it cannot be said that any have come into extensive use. Husnik's gelatine relief overlay was perhaps the earliest. It was made by coating stout paper with gelatine, sensitising with bichromate, and printing it under the negative from which the

block was made, or under a plain negative without dots. On soaking and washing this gelatine sheet, the lighter, least exposed portions were washed away, leaving the shadows and half-tones in more or less relief. When dry this formed a perfectly graduated flexible overlay.

A recent modification of Husnik's overlay, known as the De Vinne-Bierstadt system, consists in using the gelatine relief to make a mould in plaster of Paris, and from this latter a guttapercha cast is taken and used as the overlay. To avoid having recourse to the original half-tone negative, a print is taken from the block on celluloid or transparent tracing paper, and dusted with blacklead or other opaque powder, so that it may be used as a negative to print the gelatine relief.

A more simple and ingenious process of strengthening the impression in the shadows and darker tones has been patented by Dr. E. Albert. It dispenses with the overlay, and consists of the application of a peculiar underlay. A sheet of thin zinc has an image of the picture transferred to it, possibly by simply taking a proof on it in etching ink. This resist picture is strongly etched, so that the weaker tones are etched away, and the middle tones partially, the shadows being left intact. The result is a graduated plate, which is placed underneath the original etching, together with some cementing material, and the two subjected to great pressure whilst heated. When taken out the underlay is adherent to the printing plate, and the latter has been given a surface of varying relief, the shadows being the highest. The block will

therefore print without make-ready, and the author has seen excellent results produced in this way.

Somewhat similar in principle is the Arthur Cox overlay. In this case also a thin sheet of zinc is etched into high relief, and this is attached on to the cylinder of the machine or tympan of the press. It is certainly very effective, judged by results. Similar to this is the Gilbert-Harris overlay used in America.

An overlay used on the Continent is that covered by Dannenberg's patent. In this case a proof is taken from the block in a tacky ink laid on rather thickly. This proof is dusted with shellac or asphaltum powder, then the sheet is heated on a hot plate to fix the powder, which unites with the ink. A further powdering is applied if necessary to strengthen the relief, and the paper again heated. Quite a strong relief can be obtained by this means.

Still another way, also patented on the Continent, is the "chalk relief overlay," which consists in taking a proof rather full in a special ink on a paper heavily coated on both sides with a chalky enamel. A proof has to be obtained on both sides of the paper. This is obtained by allowing the first impression to set off on the tympan sheet, so that when the second impression is taken on the paper to be used for the overlay the first sets off on the back. The sheet is now immersed in a chemical solution, believed to be chlorine, which acts on the chalk coating not covered with ink, causing the chalk to dissolve away. The result is a strong and durable relief.

The "Alrevo" overlay has some good features.

Celluloid is coated with bichromated fish glue and printed under a fully inked proof of the plate. The result is a print which washes out into relief according to the light and shade of the subject. When dried it is very hard and durable.

All these overlay processes are more suitable for the machine than the proof press, but the photo-engraver is often asked by the printer to advise on the matter of overlays.

Mole's mechanical underlay does not seek to impart varying relief to the plate, but simply to correct inequalities in the mount and level up to type high. A plastic material is spread on a sheet of paper and the back of the block pressed into contact with it. Gauges surround the block to prevent the pressure platen from descending lower than type height. The plastic material sets very hard. This process is good when a number of blocks have to be made up together in a forme, as it ensures their all being type-high.

CHAPTER XVIII.

THE THREE-COLOUR HALF-TONE PROCESS.

OWING to the recent remarkable developments of trichromatic photography and its application to colour printing, this book would hardly be considered complete without some reference being made to the way in which the half-tone process is applied in this direction. It is, however, quite outside the scope of this work to discuss the principles of the three-colour process, not only for the want of space, but because the subject has been ably dealt with by various other writers.*

It is sufficient to assume that the reader knows something of the principles of the process already, and that he wishes to have information as to what variation is made in the half-tone process.

The additional apparatus required will be a set of colour filters or of glass cells in which coloured solutions are placed. Sets of colour filters can be bought ready made, viz., Lumière's for use in conjunction with the Lumière orthochromatic plates, Sanger Shepherd's for use with panchromatic plates, Wratten's for use with their panchromatic dry plates, and Klein's for use with collodion emulsion. The latter filters are also made to order suitable for any kind of plates.

* "A Handbook of Photography in Colours" (Marion and Co.) can be recommended for study, also "Three-colour Photography" by Von Hübl (Penrose and Co.), and "Collodion Emulsion," by H. O. Klein (Penrose and Co.)



Three Colour Blocks
by
The Anglo Engraving Co., Ltd.
Milford House,
Milford Lane, Strand, W.C.

SUNNY ITALY.

These commercial colour filters consist of dyed gelatine or collodion films on glass sealed to a cover glass with Canada balsam, and they are fairly permanent if not exposed to a strong light. They are recommended in preference to the liquid filters, as the latter require some knowledge of chemistry and spectroscopy to make them up properly and keep them in good order. Filters should be made on optically-worked glass.



FIG. 167.

Whichever set of filters is used provision must be made for affixing the filter plate behind or in front of the lens, for which purpose colour screen holders are made, consisting of a box which holds a sliding carrier for the filters (fig. 167). The lenses which have already been described for half-tone are equally good for colour work.

There are two ways in which the negatives may be made, viz. :

1. THE INDIRECT METHOD.—By making a set of colour record negatives through the colour filters or colour sensitive plates; from these negatives a set of positives (transparencies); and from these positives a set of half-tone negatives.
2. THE DIRECT METHOD.—By inserting the ruled screen in front of the plate and the colour filter behind the lens, thus making the half-tone and colour record result at one time.

The advantage claimed for the first method is that the half-tone negatives can be made by the usual wet-plate process, and thereby the best half-tone results are attained. Any gain, however, in this direction is more than counterbalanced by the chances of error in the six preceding operations, and the second process is now being most generally adopted.

This method involves the use of colour sensitised collodion emulsion. The latter method has an advantage in the fact that the operations are similar to wet collodion, and the negatives resemble those by this process, so that the printer is given no unusual task in printing them on to the metal.

Of late it has been found possible to make the half-tone colour negatives direct on dry plates, but such negatives are rather more difficult to print.

Attempts have also been made to colour sensitise wet collodion plates, but not with any degree of success up to the time of writing.

In the indirect method the transparencies are made by contact, and for making the half-tone negatives from them they are placed one by one in the end of a copying camera, opposite and near to a smooth whitened wall or sheet of white cardboard, which is strongly illuminated by the light of two arc lamps, or a condenser may be used with only one arc lamp.

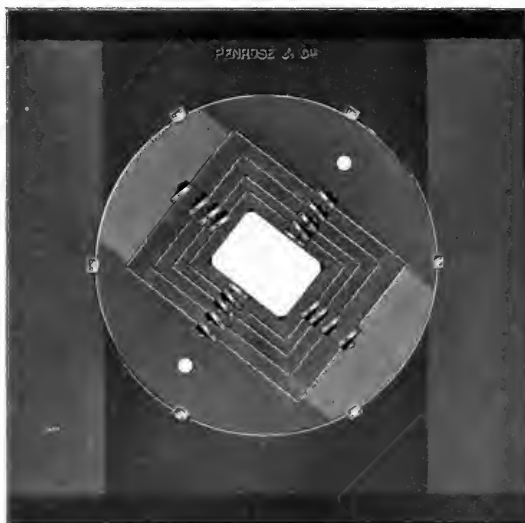

FIG. 168.

If the usual cross-lined screen ruled at an angle of 45° to the sides of the plate be used for all three half-tone negatives a pattern or moiré effect will be produced. This can be overcome by turning the original by means of a rotary copyboard (fig. 168), or having a rotating screen, or by turning the sensitive plate by means of a three-way carrier (fig. 169) to an angle where the overlapping dots will form no pattern.

Thus two elements remain fixed while a third is turned. But it is obvious that this will limit the effective size of the picture to such a rectangle only as can be got into a circle whose circumference touches the corners of the screen.

Levy's circular screen with rotating carrier (fig. 170) is the best arrangement, with the only disadvantage

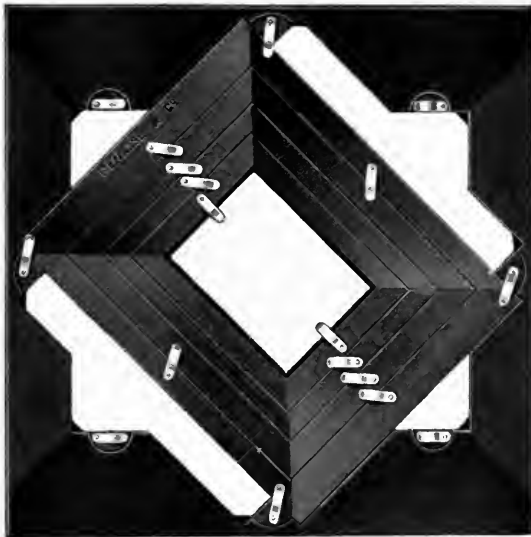

FIG. 169.

that to get a sufficiently large rectangle a large circle, and consequently a large camera, is required.

To avoid this drawback it is found good practice to have two screens of the maximum size desired, one ruled with the lines parallel to the sides, and the other with the lines at 60° to the sides; or alternatively one at 45° and the other at 75° (figs. 171 and 172). The unsymmetrical screen is reversed for the



Reproduced and Printed by

THE ART REPRODUCTION CO., LTD.

third exposure, thus giving 120° with the 60° screen, and 105° with the 75° screen. It will thus be seen that the two screens give three positions of the lines—either 45, 75, and 105, or 90, 60, and 120, according to the combination of angles selected. To enable this



FIG. 170.

reversal of one of the screens to be done it is, of course, necessary that the glass on which the screen is ruled should be as nearly as possible uniform in thickness on both sides. These paired screens are equally useful for the direct or indirect process.

The diaphragms used may be the same as in the ordinary half-tone process, and the same rules as to

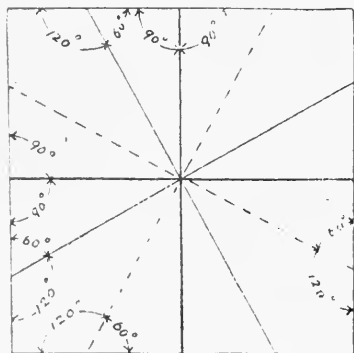

FIG. 171.

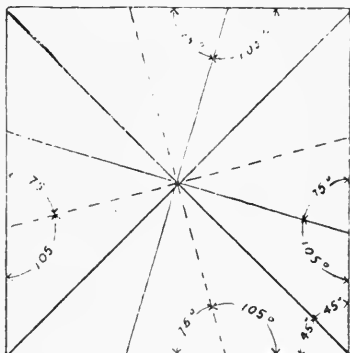

FIG. 172.

screen distance apply. The square diaphragm must, of course, be turned to agree with the angle of the screen. To promote a greater action in one direction

than another, a stop such as fig. 28 on page 77 is used. Its effect is to make elliptical dots in chain-like lines, according to the direction of the elongations. It is placed in a different direction for each colour.

Whilst dry filters are to be strongly recommended, they are expensive when made up on optically-worked glasses, and beginners who wish to start in an inexpensive way may employ a single glass cell (fig. 173),



FIG. 173.

which must be washed out after each solution. Sets of three optically-worked cells which do not disturb the focus are expensive, but by using a single cell a cheap one may be employed, and the focus will remain constant for the three exposures, even though the cell may not be optically accurate.

Dr. Koenig's formulæ for liquid filters made up with the dyes of Meister Lucius and Bruning are

reliable, and are as follows for a tank of 5 mm. separation between the glasses :

A stock solution of one per cent. strength of the three dyes is first made up.

Blue filter for the yellow printing plate.

Violet crystals (stock solution)	4 cc.
Water	100 cc.

Green filter for the red printing plate.

Patent blue (stock solution)	8 cc.
Flavazine (stock solution)	4 cc.
Water	100 cc.

Red filter for the blue printing plate.

Red filter dye I. (stock solution)	3 cc.
Water	100 cc.

Some workers prefer to use an "ordinary" dry plate for the yellow printer, exposing through a cell filled with 1% solution of quinine sulphate, which is made to dissolve by the addition of a drop or two of sulphuric acid. For the red and blue printers a panchromatic plate is used with the following filters :

Green filter.

Rapid filter green (1 in 100 solution)	2 parts.
Naphthol green	ditto	2 "
Rapid filter K	.. ditto	2 "
Distilled water	230 "

Red filter.

Rose bengal (1 in 100 solution)	3 parts.
Rapid filter K	.. ditto	3 "
Water	30 "

Collodion emulsion offers great advantages for three-colour work, owing to the facility with which it can be sensitised for different portions of the spectrum by the admixture of suitable dyes. It affords an economical and convenient means, ready to hand, of making

three-colour negatives, and there have now been introduced upon the market suitable sensitisers for it as well as screens of the proper absorption value. These screens, known as Klein's colour filters, do not cut out all the rays except those intended to act, but rely on the insensitiveness of the plate to the other rays. In this way a comparatively transparent colour filter is obtained which does not require unduly long exposures. There are two sensitisers, marked respectively R and C, the first for the red and the second for the blue printer. No sensitiser is needed for the yellow printer. The exact composition of the solutions is a secret, but it is understood that the first is a fluorescein-silver compound, and the second is a pure anilin dye to which compensation dyes have been added. They are either added to the emulsion or flowed on the plate before exposure. The ratio of exposures with Klein's colour filters and trichrom emulsion (Klein's formula) is 1 : 2 : 2 for the blue-violet, green, and red filter respectively.

The exposure through the red filter can be considerably reduced by putting special carbons in the arc lamp, so as to give a reddish light. A new arc lamp has lately been introduced by Penrose and Co., with arrangements in it for changing the colour of the light three times. Direct half-tone and chromatic negatives may be made with collodion emulsion, or it can be used in the more roundabout way of making chromatic negatives, positives, and half-tone negatives.

Considerable progress has been made of late in colour sensitising ordinary dry plates by bathing in

dye solutions, and it is found that much greater sensitiveness can be obtained in this way than by mixing the dyes with the gelatine emulsion. The following are some of the principal dyes used up to the time of revising this book :

Ethyl red	Panchromatic.
Homocol
Pinaverdol
Orthochrome T
Pinachrome
Pinacyanol	Red sensitive, high speed.
Dicyanine	Sensitive for extreme red and infra red.
Tetra-brom-fluoresceine	Green sensitive.
Di-iodo-fluoresceine

The first five are almost precisely similar in their action.

Red sensitive plates should be handled in weak green light ; other plates in a weak ruby light.

The operations of bathing and drying are somewhat delicate, and as bathed plates can be had commercially it is not necessary to describe the system of bathing.

By whatever process the chromatic negative result is obtained, the routine will resolve itself into the ordinary half-tone process, when the stage is reached of printing the negative on to the metal and etching. Great care, however, must be taken to get the three prints of equal tone value, and the same relation must be preserved in the etching. It would not do, for instance, to over-print or over-etch one of the results. The most perfect system would be to expose all three plates at one operation, develop all three negatives at one time, and to print and etch all at the same time. With the improvements made in filters, sensitisers, and panchromatic plates, the difficulty of securing equality of result in the three negatives is not so great as

formerly, and with reasonable care there should be no difference in the values of the three negatives. It is a good plan to pin up alongside the picture a grey scale made of different shades of exposed and developed platinotype paper, which scale should be rendered with equal density in all three negatives. A colour scale formed of the inks to be used for printing should be also photographed as a guide, its monochromatic representation being always rendered the same without regard to the general appearance of the negatives. Uniformity of the half-tone dot effect in the three negatives is essential. It is to be remembered that in the best possible negatives the half-tone process must necessarily lower the key of the colour values, and the contrast must be brought back by judicious fine etching. Colour results claiming to be done without fine etching generally give one the impression that a little of it would have improved the result.

Three-colour work is one of those things for which no set rules can be given. The worker must first be a skilful craftsman in the black and white half-tone process, and especially a good photographer. Then he only requires a good set of colour filters and colour sensitive plates or emulsion of good repute to start him on the right path which will lead him to a successful issue, if he follows it with a definite aim, and adheres to rules and principles given him either by the plate makers or by the filter makers.

A word must be said in conclusion about the inks with which the blocks are to be printed. Here the worker will most likely encounter his greatest pitfall,

and to avoid it he should make careful preliminary enquiry as to the inks recommended as suitable for given filters.

The difficulty is that no inks have yet been discovered which will render the colours of nature perfectly in three printings, yet a sufficiently close approximation can be obtained for all practical purposes. The inks nearest to theoretical requirements are, unfortunately, not permanent, being aniline colours, but they are sufficiently so for use as book illustrations or other purposes where they will not be exposed to strong light. The permanent inks are not so transparent nor so correct in colour rendering, yet they come very near to the required standard, and most printers prefer to use them. A slight correction of colour values in the blocks can be made to allow for any excessive strength of one colour over another.

Some ink makers send out a "mixing white" for reducing the intensity of any particular ink, but such a course is not to be recommended. The order of printing the colours is invariably yellow, red, blue.

The Autochrome, the Dufay plate, and other screen plate processes are useful for making test colour transparencies direct from the object, and these form an excellent guide to the colour etcher. The Autochrome plates have been employed as originals for reproduction by transmitted light, the three separate half-tone negatives being made therefrom through colour filters.

The four-colour process is, of course, merely an extension of the three-colour process. Another filter

is used, commonly called the "grey" filter. Usually it is a yellow or reddish orange, and gives an orthochromatic reproduction of the whole picture. The block from the resulting negative is etched so as to add black to strengthen the shadows, to render neutral greys, and deepen the darker shades of blue and red. The printing is done with black ink.

Care has to be taken in selecting the angles of the screen rulings for four-colour work, or an objectionable moiré pattern will be formed when the fourth printing is added. Some workers arrange the angles of the screens $22\frac{1}{2}^\circ$ apart, but there is a danger that with some work patterns may be formed. A better arrangement is to have 15° between the red and yellow, and 30° between the blue and black. The following positions are said to give no pattern: Red 60° , yellow 75° , blue 90° , black 120° ; or black 45° , red 75° , yellow 90° , blue 120° . Another arrangement is: Black to blue 30° , blue to yellow $17\frac{1}{2}^\circ$, yellow to red $17\frac{1}{2}^\circ$. By means of the Levy circular screen and rotary carrier variations of the angles are easily obtained, but where only two screens are available the copyboard may be turned 15° between the red and blue when making the yellow plate. Another way if the size of camera will permit it is to have a carrier made to throw one of the screens 15° out of perpendicular. The best way of all, short of having a circular screen, is to employ a third screen. For instance, if the existing pair of screens are 45° and 75° , the turning of the latter will give 105° , and a third screen should be 90° . If, however, the pair is

90° and 60° , the latter giving 120° when turned, the third screen should be 75° .

In any case, one has to be careful to put the yellow between the red and the blue or there will be a pattern, since black will not work nearer than 27° with any colour without giving a pattern. Blue and red will work together at 25° , whilst yellow can be placed as close as $12\frac{1}{2}^\circ$ to the red or blue.

CHAPTER XIX.

DUOTYPES OR TWO-COLOUR
HALF-TONES.

HALF-TONES may be made much more effective in appearance by printing under them a second impression in a lighter tint of ink. The same block may be printed twice, the second printing being slightly out of register with the first, and in a lighter shade of ink. Or a second block may be either a plain tint, usually printed in a light fawn-coloured ink; or it may be a second block from the same negative, but etched lighter and certain tones given prominence. To avoid any risk of moiré pattern, another negative is made at a different screen angle, as in three-colour work. The circular screen comes in very useful here.

No special instructions are needed for the making of such blocks, as the operations are the same as for making single colour. More really depends on the artistic perception of the etcher than upon the operator. Often the etcher will only ask for two prints from the same negative, and on one of them for printing the lighter tint he will produce a totally different result from the first. It is, of course, simply a matter of stopping out and re-etching until the desired effect is obtained.



CAMERA PORTRAIT BY HOPPE
REPRODUCED BY
HENTSCHEL DUO-TYPE.
CARL HENTSCHEL LIMITED.
LONDON, E.C.

Another excellent way of producing the tint plate is by taking the second negative through the metzograph screen. In this manner no pattern can possibly be formed, and the result is very soft and artistic.

In printing these duotypes the aim is generally to choose inks which will match the tones of the photograph, and the result may be made more realistic if a varnish film is printed over the half-tone from a plain tint block. In this way the effect of a glossy photograph is obtained and the shadows are much richer.

Excellent colour effects may be obtained by using only two colours. For instance, a landscape or seascape may be printed from two blocks, one giving a bluish green and the other a brown or black. Portraits may be printed with one block in a reddish tint and the other a blue black. Further pretty effects may be obtained by means of complementary colours.

Sometimes the second block is not made in half-tone at all, but with a resin or bitumen grain, using a carbon print as a resist, as in the photogravure process. Or a set-off may be laid down from a half-tone negative and used simply as a guide to be painted over by the etcher in stopping-out.

In machinery and catalogue illustrations generally very effective illustrations may be made by emphasising certain parts with solid tints, as, for instance, a yellow to indicate brasswork, a steel blue for iron or steel, and a green or blue or other colour to represent painted parts of the ironwork.

In maps also the hill shading and other contour and detail may be done with half-tone in black, whilst ground tints are employed to represent different districts or territories.

There are, in fact, an infinite number of variations which may be played in reproduction with the half-tone as a basis.



TWO TINTS IN ONE PRINTING BY THE
HALF-TONE ENGRAVING CO., LTD., 25
AND 10-20, FARRINGDON AVENUE, E.C.

CHAPTER XX.

PHOTO-LITHOGRAPHY IN HALF-TONE FOR THE OFF-SET PRESS.

I N Chapter XIII., page 274, the various photo-lithographic processes are described, but until the introduction of the off-set press photo-lithography in half-tone had no great vogue, the reason being the

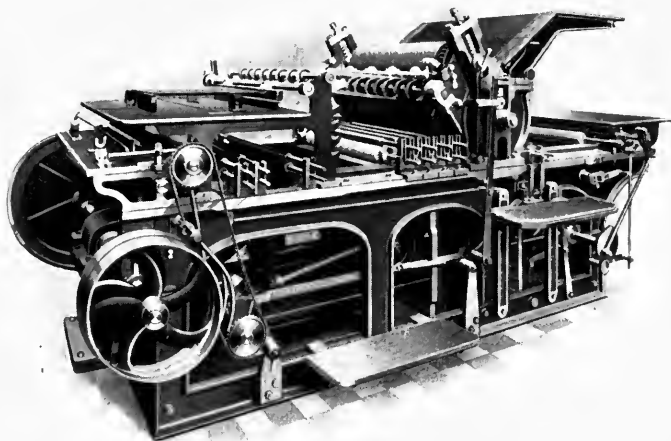

FIG. 174.

results obtained by lithographic printing were in no way comparable with the brilliant effects obtained in printing from typographic blocks. Another drawback was the fact that the lithographic image could not be operated on by fine etching as in the case of relief blocks.

The off-set press has, however, created a demand for half-tone transfers which must be met. The principle of this press is that the image is first "set off" on to an indiarubber sheet, and thence on to the paper, instead of printing direct from the stone or plate on to the paper. The advantage of this is that the roughness or inequality of the surface of the paper does not matter, as the rubber sheet, so to speak, moulds itself to the character of the paper.

It was found that a half-tone image printed extremely well, even on quite coarse surfaced papers, if worked on the off-set press, and the results obtained were quite marvellous in quality compared with what had hitherto been done by printing half-tone in the lithographic way. Half-tones up to 200 lines per inch were printed by the off-set method on uncoated papers of comparatively coarse surface.

A few good results of this nature awakened keen interest in half-tone for off-set, and many experiments have been made to discover the kind of plates best suited for off-set printing. Most half-tone workers thought it quite easy to coat a piece of zinc by the albumen process (page 274), print under a half-tone negative, roll up, and proceed to print. But it was soon found that the task was harder than it seemed. The results were flat and smudgy, and the image in many cases lifted from the plate or gradually dissolved away in the more delicate portions.

The reason for this trouble was, in the first place, that the negative for making a relief block was quite unsuitable for lithographic purposes, and, secondly,

any process of printing the image on to the metal where there was an albumen or colloid film between the ink and the metal was unsuitable, because the acid used in surface etching the image so as to clean up the work tended to dissolve the film under the ink and cause it to lift or crumble away.

It is now generally established that the negative for off-set printing must be of a totally different character from that for block printing. What is known as a "bright" negative is required, or what the ordinary photographer would call "hard" or "contrasty." By making the print from such a negative the image comes pretty much as it should ultimately print, without having to brighten it up by fine etching. As a matter of fact, such a negative is easier to make than the orthodox negative for block-making, being the kind of result produced by "straight" photography without resorting to intensifying, cutting, etc. The high lights will be well closed up, so as to yield fine dots on the print, and the shadows will be transparent, with little or no dot in the deepest parts, so that they print a true black. The half-tones will possess a nice even gradation.

Having obtained such a negative, the next step is to select the suitable printing process. Paper transfers may be used, but, except in the most skilful hands, do not yield the best results, owing to the tendency to squashing or spreading. The direct printing on metal undoubtedly gives the sharpest and crispest results, but the process must be one which will bring the ink of the image or something analogous to ink next to

the metal, with no albumen or glue film between. The bitumen process would be ideal for the purpose were it not so slow.

A process, however, which combines the advantages of bitumen with the speed of fish glue is the Redcol process. In this case the metal is first flowed with an alcoholic solution of a resinous body which gives a varnish film to the plate. The varnish is a proprietary article sold by Penrose and Co. When the varnish is dry the plate is coated, on top of the varnish, with fish glue and then printed as usual under the negative. The glue image is then developed with water until the spaces between the dots are laid quite bare, showing the varnish ground first applied. The fish glue image is then dried, and the plate is put into a bath of methylated spirit for a few seconds. This causes the varnish between the dots to be dissolved away, and we now have varnish dots with a cap of fish glue. The latter is got rid of by wetting the plate and rubbing away the fish glue with a tuft of cotton or a soft brush. The final result is a half-tone image in acid-resisting varnish. A "passing" bath is given, and then the image is gummed up, rolled up, and printed from in the ordinary way. The image can also be washed out and rolled up again.

Another way of obtaining a varnish image next the metal is to print as usual with an albumen bichromate film on the plate, using a very thin solution. When the print has been inked up, developed, and dried, the plate is coated with a thick gum, which fills up the spaces between the dots. This gum having been

allowed to dry, the plate is flooded with turpentine to wash away the ink image. When this has been done the plate is brushed over with "Mogul" lithographic varnish. This takes the place of the ink, and when dry the gum can be washed off, carrying away with it any varnish lying on top of the gum. The varnish image can then be rolled up, washed out, and prepared for printing.

The two foregoing processes are quite serviceable where only a single image is required on the plate, but where several duplicates have to be put down a retransfer method must be adopted. The first image may, of course, be rolled up with transfer ink and retransfers pulled on suitable transfer paper, but the pulling of the half-tone transfers requires great skill and experience. For this reason another process has been adopted with success, viz., that of making an intaglio copper plate. In this case the half-tone dots are etched into the plate instead of standing out in relief or lying on the surface of the plate. The lithographer need then only pull the transfers in the usual copper plate way, by smearing the plate, which is made warm, with a stiff transfer ink and wiping the surplus ink off the surface with a pad of muslin or special wiping canvas. The transfer paper used is that known as "Scotch," which has a chalky surface, and the proofs are best pulled in the copper plate press, though if this is not available they may be pulled in the lithographic press. On such transfers a good body of ink is obtained, and any good lithographer who has been accustomed to laying down

copper plate transfers will find no difficulty in transferring them.

An advantage of this method is that the copper plate may be fine etched in the same way as an ordinary half-tone, so as to remedy any want of con-

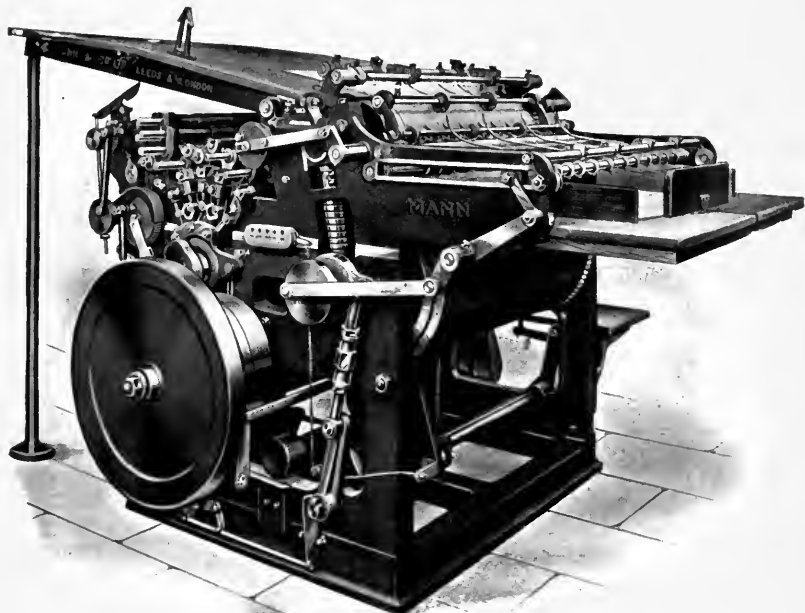

FIG. 174a.

trast. Some judgment is required as to the depth to carry the etching, and also as to the size of the dots in the different parts of the plate.

It should be noted that the prints for offset, do not require to be reversed on the plate, as in the case of prints for typographic methods, because the offset press reverses them before applying them

to the paper. With photographic methods it is only necessary to remove the prism or mirror from the camera, and take the negative in the ordinary direct way, in order to get the image the correct way on the plate.

It is not for the author to deal with the printing of the half-tones on the off-set press once the image is on the plate, but it should present no difficulties to those who have become accustomed to the manipulation of the off-set machine.

Of course, the processes here described may be equally well applied to ordinary lithographic printing, either from zinc, aluminium, or stone.

Fig. 174a is a flat bed offset machine and fig. 175 a typical rotary offset machine. The former is similar to an ordinary lithographic machine, except that it has a second cylinder for carrying the rubber offset sheet, and the latter is similar to a rotary zincograph machine except for the extra cylinder for the offset sheet.

CHAPTER XXI.

PREPARATION OF ORIGINALS.

THE preparation of originals for half-tone reproduction has become an important branch of the photo-engraving industry. It is found desirable, in the case of commercial subjects particularly, to retouch the photographs, so as to increase contrast and bring out detail, as well as to soften harsh or intense shadows, and to eliminate undesirable objects in the background.

Where the photo-engraver is able to choose the style of print best suited for his work, he will select glossy bromide prints, developed with metol-hydroquinone ; or squeegeed p.o.p. prints, toned to a deep purple ; or deeply toned albumenised paper prints, well burnished. Generally speaking, the smoother the surface of the print the better it is suited for reproduction.

An Aerograph (figs. 175 and 176) is an indispensable adjunct to this department, and it is perhaps hardly necessary to explain (so well known is it) that this apparatus is for spraying colour on to drawings or photographs by means of compressed air. The air supply is obtained by means of a foot pump, charging a small reservoir to a pressure of about 15 lbs. to the square inch.

In large establishments it has become the rule to have a motor-driven air compressor (fig. 177), serving a number of the hand pieces, the air supply being led to the artists' benches by means of pipes, and turned on as required, like a gas or water supply. By such



FIG. 175.

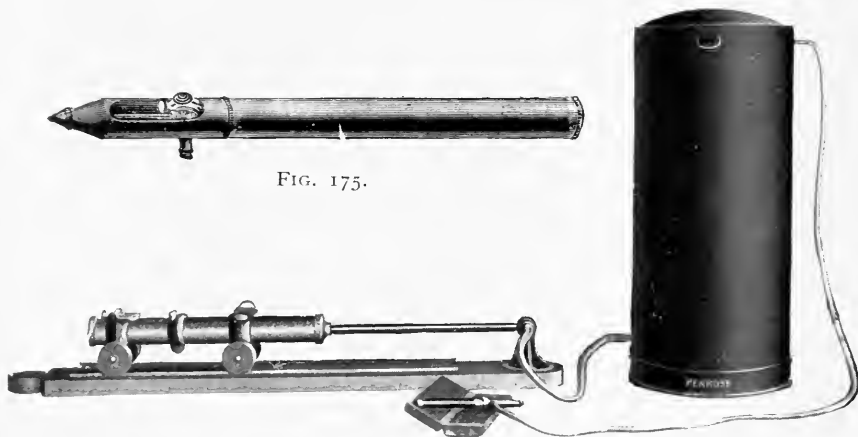

FIG. 176.

means it is possible to get up a pressure of 20 to 30 lbs. or more, and maintain it constant by automatic regulation. The advantage of a higher pressure is that a finer spray can be produced and a thicker body colour can be sprayed.

The other requirements of this department are simply the usual drawing instruments, such as ruling pen, compasses, 6in. parallel rule, mapping or lithographic pen nibs, sable brushes (Nos. 2 to 8), saucers and tiles, and a drawing-board; also an assortment of colours, comprising Chinese white, Blanc d'Argent, Albanine, Ullmanine (a process white), raw sienna, Indian red, brown madder, sepia, lampblack, water-

proof Indian ink, oxgall (in liquid or paste), a piece of gum arabic, and some Bristol and other cardboards for mounting. A small sharp pair of scissors and a pen-knife are required for cutting out prints, as it is sometimes preferable to cut away all the background of a print, mount it on a board, and fill in the background by means of the Aerograph and by drawing. Some soft black pencils of the kind known as "Negro" are useful when working on bromide or platinum prints.

To prepare a glossy print so that it will not repel the colour, it should be rubbed over with a sponge dipped in a solution of oxgall and water. A general rule in retouching prints is to select and mix the colours to match as nearly as possible the tints of the original to be worked up. A medium or warm-toned silver print, for instance, should be worked up with brown madder, sepia, black, and Chinese white, mixed to a tint most closely matching the colour of the print. If of very warm tone, Indian red may be used instead of brown madder in the mixed tint, and with brown madder cooled slightly with black and a little gum arabic for the shadows. Gum arabic must invariably be added to the deep shadows, as it is of the utmost importance that the glaze of the original surface be preserved in these portions. On no account, however, should this glaze be mixed with the half-tone body colour which is being used, nor for the high lights. Ullmanine white (or Process White) must be used for the high lights where pure white is desired. Chinese white should never be used for this purpose, as it generally comes out as a half-tone tint in the negative

and subsequent reproduction. This may be remedied by photographing through an Æsculin filter, or through a liquid filter consisting of one per cent.

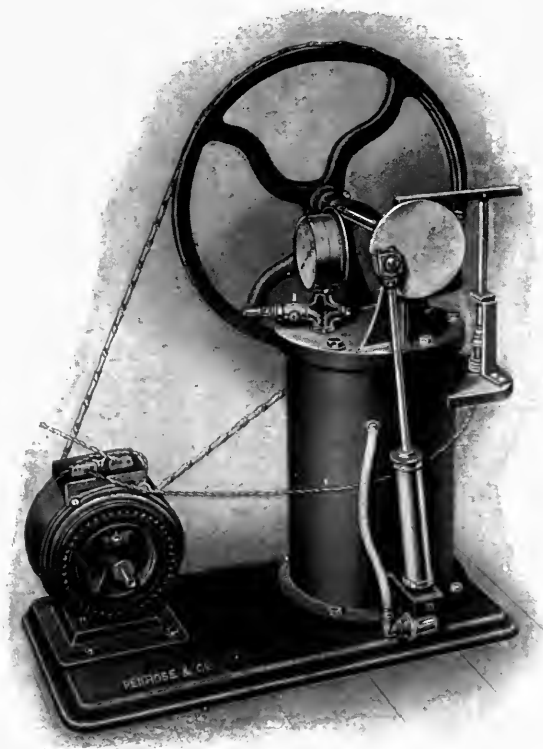

FIG 177.

quinine sulphate. Chinese white is, however, useful for mixture with other colours for half-tone washes. Process White is equally unsuitable for mixture with a body colour.

Bromide prints, both smooth and glossy, should be worked up with lampblack mixed with sepia and Chinese white. Without the addition of sepia the colour will be too blue, and will, therefore, not photograph in the same relation to the colour of the print. Again, when only slight strengthening of details is required, lampblack with a small proportion of sepia and gum added to match the surface of the print will be found most serviceable.

The most frequent requirement is the painting-out of backgrounds. It was formerly the most general practice to cut a cardboard or paper mask to protect the parts not to be covered by the painting-out medium, but this tended to give a ragged or hard outline. The more modern practice is to paint over the parts to be protected with celluloid varnish, to which a little colouring matter such as Venetian or Indian red in powder has been added. This enables the part stopped out to be readily seen. By this treatment it is possible to afterwards go over these parts with a tuft of cotton-wool soaked in amyl acetate and remove the surplus paint which may have got on where not wanted. Masklene is a ready-made preparation sold for the same purpose. Larger spaces, such as skies and backgrounds can be marked out with a cut-out of a stiff transparent tracing paper, sold specially for the purpose. The cut-out is attached to the print with rubber solution.

The background can be sprayed on by means of the Aerograph charged with white paint, and if the background is rather dark it will be necessary to go over it again and again until sufficiently covered.

Scrupulous cleanliness is necessary in handling the Aerograph, and the pencil or hand piece should be always kept in its case when out of use. The air should be pumped into the cylinder to full pressure whilst the tube is kept squeezed, and then released for a moment to blow out any dust inside the tube before attaching the latter to the pen.

Having mixed the colour in a clean saucer, it should be transferred to the receiver of the Aerograph by means of a brush. A little should be sprayed in the air before treating the original, to make sure that all the water is expelled, and that the brush is working properly.

The Aerograph should be held about 6in. distant from the original, the lever of the handpiece pressed down and slightly backwards, and the point moved horizontally with a gliding sweep from left to right, beginning at the top left-hand corner and releasing the valve at the end of each journey until it has travelled in this way downward over the whole space to be covered. It is impossible to obtain fine lines or sharp edges with the air brush; masks of thin tracing must therefore be used to spray over for this purpose. These are sometimes attached to the print temporarily with indiarubber solution. Vignetted edges are obtained by first spraying on the white, and then a grey, which is gradually deepened by further spraying away from the edge. The desired softness is obtained by increasing the distance of the Aerograph point from the original.

Water colours which dry with a gloss can be obtained, specially made for working up glossy photographs. They are mixed with albumen.

Mr. F. W. Brookman, to whom the author is indebted for the notes contained in this chapter, says that the class of originals best adapted for reproduction by the half-tone process are those which are free from any distinctive colour. Among the best may be mentioned (1) monochrome paintings in flatted oil, in which ivory black mixed with raw umber is used in conjunction with flake white; (2) monochrome paintings in water-colour, in which lampblack mixed with sepia is used in conjunction with Chinese white, with a good process white for the high lights; (3) glossy bromide papers; (4) glossy p.o.p. toned in a rich gold bath to a deep purple, and free from double toning; (5) deeply toned albumenised paper prints.

Wood, steel, or copper-plate engravings are undesirable if they contain mechanical ruling, as it combines with the ruled screen to give a watered silk effect. Photographing from a half-tone also gives a pattern, but this can be overcome by rotating the copy until the pattern ceases to be visible. This will happen when the original is at an angle of 15° to 75° from the ruling of the half-tone screen. Another way of photographing from a half-tone without showing pattern is to place over it a piece of finely ground glass which has been rubbed over with a trace of glycerine. Coarse half-tones can, of course, be photographed without the screen as if they were line subjects.

APPENDIX.

MICROSCOPIC MEASUREMENTS BY N. S. AMSTUTZ OF THE BLACK
DOTS FORMING THE HIGH LIGHTS (*i.e.*, SKY) OF THE PRINTS
OF THE "FLAT-IRON BUILDING."

(*See Fourth Edition of "The Half-Tone Process."*)

Note.—These measurements include the whole area of the printed black dot, part of which is due to the spreading of the printing ink. The corresponding dot on the etched plate was, of course, smaller, since the spreading of the ink adds up to 0.001 inch to the diameter of the dot.

Screen Used. Lines per inch.	Approximate "Diameter" of Black Dots of Print. Inch.	Approximate Area of Black Dots of Prints, in Millionths of a Square Inch.	Measurements of Squares of Original Screen used.	
			Length of Edge. Inch.	Area in Millionths of a Square Inch.
60	0.0039	15.2	0.008	64.0
75	0.0031	9.6	0.0066	43.5
85	0.0031	9.6	0.0059	34.8
100	0.0027	7.3	0.0050	25.0
133	0.0016	2.5	0.0037	13.7
150	0.0008 = 0.0016	0.6 = 2.5	0.0033	10.9
175	0.0008 = 0.0012	0.6 = 1.4	0.0028	7.8
200	0.0004 = 0.0008	0.16 = 0.6	0.0025	6.2
400	0.0008	0.6	0.0012	1.5

These measurements relate to blocks which appeared in the last edition of "The Half-Tone Process," but approximately apply to the similar series of blocks in the present edition for the same rulings of screens.



INDEX.

	PAGE
A CCESSORIES, Camera	82
Achromatism	73
Acid, Acetic 34, 90, 218, 237, 238, 239,	242, 244, 271, 317
— blast	318
— Citric	239, 240
— Formic	239
— for cleaning screens	34
— in bath	216, 234
— — developer	218, 238, 239
— Hydrochloric	235, 249, 296
— Nitric 222, 236, 239, 241, 299, 300,	306, 307, 309
— Nitrous	317
— resist varnishes 225, 297, 300, 305	
— Sulphuric 235, 239, 246, 296, 307,	311
Actinometer	128, 276
Adjustment of screen	55
— — arc	144
— — etching machine	320
Aerograph colours	373
— The	372
— Esculint filter	375
Air compressor, Motor	373
Albaniine	373
Albert's etching machine	325
— relief process	345
Albumen 219, 236, 243, 246, 275, 278,	285, 287, 292, 294
— bichromate solution	123, 275
— substratum	236
— Developing, prints	277
— prints etching	299
— process	274
Almond oil	283
Alrevo overlay	316
Alternating current	143
Alum	134, 223, 274, 307
Aluminium screen binding	35
American copper	227
— etching ink	277, 303
Ammonia 34, 134, 236, 237, 242, 246,	275, 277, 283, 288, 294, 308, 341
Ammonium bichromate 221, 278, 285,	292, 294, 295
— chloride	242, 252
Amphitype	282
Amperes	138
Anchoring system	340
Angles of screens	33, 352
Aniline dye	289
— violet	279, 288
Anthony holder	52
Apochromatic lenses	75
Are lamps, Copying	138
— — for colour work	155
— — enclosed	138, 141, 142
— — — printing	115, 138, 147, 154
— — open type	137
— — Placing of	256
— — stand	152

	PAGE
Are Lamps, traversing gear	152
— Length of	115
— light screen	145
— position of	145, 151
— Reflectors for	146
Argentometer	102, 231
Arthur Cox overlay	346
Asbestos board	166
Asphaltum	224, 277, 279, 280
— Waxed	278, 284
Astigmatism	73
Atzpinsel	169, 310
Automatic screen adjustment	62
Autometric dropping bottle	106
Autochrome plates	359
Auto-focal camera	63

B ACKGROUNDS, Engraving ..	332
— — Painting out	376
Baking plane	206
— plates	253
Bars in plate-holders	53
Basins, Evaporating	107
Bates's black	226
Bath	96, 100
— box	96, 99
— bottle	106
— boiling down	108
— Flat	100
— graining	132
— hooks	101
— Iodising	254
— Making up	233
— silver	232
Bathing dry plates	356
Beaumé hydrometer	164, 222, 309
Beeswax	224, 281
Bellows	166
Benches, Dark room	95
Bench liner	183, 335
Benster holder	52
Benzine	134
— can	213
Benzole	226, 279, 280
— solvent	279
Bevel plane	191
Beveller	201
— Liming	202, 335
Bevelling	190, 334
Bichromate hardening solution	297
— of potassium	236, 246, 275, 282
— solution	275
Bichromates	221
Binding of screens	35
Birmingham wire gauge	228
Bitumen	100, 167, 225, 279
— and beeswax for baths	100
— process	279, 302
Blanc d'Argent	373
Bleaching negatives	241
Blocking plate	191
— press	210

INDEX.

	PAGE		PAGE
" Blue " process	278,	Colours for aerograph	373
Board of Trade unit	110	Comets	105
Bonanza holder	52	Cone whirler	121
Bottles	125	Continuous current	139, 112
— Bath	106	Cooke process lens	73, 258
— Collodion	101	Cooling enamel plates	131
— Dropping	106	— trough	166
— Bowler " trimmer	201, 339	— slab	131, 169
Brass	228, 309	Copper	227
Bromide of potassium	211	— bromide	241, 213, 215
— prints, Reproducing	266, 378	— etching	309, 313, 321, 323
— Preparing	376	— plates, infaglio	369
Bromides and iodides	217	— silvering	341
Brunswick black	226	— sulphate	238, 211, 311
Brush, Etching	168	Coppering zinc	341
— for rubber edging	111	Copy, Fixing up	69, 83, 255
— Powdering	168	— Illumination of	150, 256
Brushes	111, 168, 174	— Nature of	266, 272
Bulb, Specific gravity	108, 216	Copying board	68
Bull's-eye lens	178	— half-tones	61, 71
Bunsen burner	109, 122	— stands	61, 71
Burnisher	175	Copyholder	83
— Use of	312, 332	Cored carbons	143, 356
Burning-in enamel prints	289	Cotton, Gun	217
— stove	116, 129	— wool	34, 81, 118, 123, 121, 271, 277, 281, 287, 293, 296, 298, 299
C AMERA	14, 60	Crayons	316
— stand	64	Cupboard, Drying	88, 216
Calmel's powder	278	— Roller	133, 214
Carbon tissue	297	Cups, Developing	105
Carboys	222	Cut-out half-tones	316, 330, 336
Carboy stand	159	Cutting solution	241, 242, 245, 252
Carbons	144, 356	Cyanide	235, 239, 240, 245, 252, 311, 341
Castor oil	217, 244, 279	— of silver intensifier	252, 271
Caustic potash	246, 251, 294, 297, 305, 317, 341	Cycles of alternating current	143
Cell, Glass, for colour process	348, 354	Cylinders, Arc lamp	141
Celloidin	217	D ALLMEYER lens	74
Celluloid varnish	244	— Damping rags	173
Centric screen gear	57	Danesi etching machine	326
Chalk	235, 343	Dannenberg's overlay	346
— relief overlay	346	Dark room	49, 84
Chamois leather	124, 235, 311	— Heating of	87
Charcoal	115, 132	— Illumination of	92
Chessboard formation of dots	262, 265, 268, 269	— lantern	93
Cheese cloth	124	— Ventilation of	85
China silk	34	— operations	267
Chinese white	373, 376	Deep etch	314
Chipping plate	191	— etched half-tones	316
— tools	192	Dentist's drill, Use of	181, 317, 331
Choking coils	156	Depth of etching	300, 301
Chloroform	279, 280	Developer	218, 238, 247, 251
Chrome alum	131, 223, 237, 287, 306	— Glycin	218, 247
Chromic acid	223, 286, 294, 307, 311	— Hydroquinone	248
Circular screens	33, 353	— Metol	251
Cleaning copper and zinc	271, 287	Developing cups	105
— glass	235, 246	— albumen prints	277
— screens	34	— fish-gluce prints	289
Clip copyboard	69	— wet plates	267
Coarse half-tones for newspaper work	32	De Vinne Bierstadt overlay	345
Cold enamel process	291, 308	Diaphragm, Adjustment of	63, 72
Collinear lens	74	— Choice of	258
Colour cells	74, 348, 354	— Round	265
— filters	348, 354	— Rule for	259, 264
Collodion	216, 234, 237	— Shape of	261
— bottles	104	— Size of	259, 264
— emul-sion, . . . 33, 112, 218, 244, 350, 355		— system	76, 262
— stripping	244	Diaphragms	72, 76, 259
— Wet	232	— for colour work	77, 353
Cologne glue	291, 308	Dicyanide	357
Colour filters	348, 354, 360	Di-iodo fluoresceine	357
— ganges	211, 212	Diffraction	24
— screen holders	349	Dippers	97, 99
— scale	358	Dipping bath	96, 98, 232
— sensitisers	356	Direct method in colour work	350
		Dishes	101, 112, 125

INDEX.

	PAGE
Distance of original	43
— — screen 72, 253, 259, 263, 265,	272
Distilled water	233
Dividers	194
Dots, Shape of	262
— High light and shadow	269, 272
— Joining up of	262, 268
Dragon's blood	167, 225, 277, 278, 303
— — process	304, 305
— — —	130, 302
Draining boards	90
Draw tool	334
Dried albumen	219, 236, 275, 287
Dropping bottles	106
Dry enamel process	294
— plates	112, 232, 250, 270
Drying of wet plate	271
— albumen plates	275
— cupboard	88, 246
Dufay plate	355
Dutypes	362
Dust, Prevention of, in dark room	87, 112
Dusting box	332
Dye solution	289, 292
Dyes, Sensitising	245
Dynamo	137, 139
E ASEL, Copying	47, 68
— Ebonite baths	100
Eclipse copyholder	83
— "Economic" screen	30, 36
Economy coils	157
Edging	237, 244, 246
Egg albumen	219, 237
— whisk	123, 220, 285
Electric engraving tool	317, 331
— fan	49, 86, 167
— lamps for dark room	93
— light installation	137
— motors	197
— pen	181, 317, 331
— radiator	49, 88, 166
Electrolytic coating of zinc and	
— copper	311
Elliptograph	179
Emery	114
Emulsion and dry plates 112, 245, 248, 270	
— Collodion	33, 112, 218, 232, 241
Enamel process	220, 284
— — on zinc	305
Enclosed-arc lamps	138, 141, 149
Engravers' magnifying glass	177
— ruling machine	181
Engraving on half-tones	317, 330
Engravings, Reproducing	378
Eosine	289
Etcher's point	173
Etching brass	309, 310
— brushes	168, 301
— clamp	161, 310
— Cold enamel	308
— Copper	309, 313
— Duration of	313
— enamel plates	306
— face down	310
— ink, American	277, 303
— machines	318
— needles	171
— points	174
— powders	224
— room	158
— solution for zinc	307
— — Heating the	310
— the plate	299
— trays	163
— tools and sundries	173

	PAGE
Etching troughs	162
Ether	34, 100, 217, 237
Ethyl red	357
Evaporating basins	107
— stove	107
— the bath	235
Exposure, The	265, 266
— of albumen prints	276
— — fish glue prints	288
— — to white paper	265
Eyeieces, Focussing	82
F ABRIC, Non-actinic	93
— Falz and Werner's screen gear	59
Fan, Electric	49, 86, 167
Farmer's autofocal system	63
Ferrieyanide	242, 249, 251
Felt	124, 128
Film negatives	279
Films, Printing with	279
— Removing old	236
Filters, Eosulin and quinine	355, 376
— Colour	348, 354, 360
— Collodion	104, 105
— holders	349
Filtering fish glue	123, 285
Fine etcher's bench	158, 184
— etching	312, 323
Finishing and mounting	330
— ink	224, 305, 312
— etch	305
Fish glue	123, 220, 284, 285, 293
— — prints, Developing	289
— — process	220, 284
Fixing solution	239, 248
Flame carbons	157
Flannel	124
Flashing	265, 273
Flat baths	100
Floor rails for camera	48
Focussing	71, 257
— arc lamps	118
— cloth	82
— eyeieces	82, 258
— the dot	260, 261
Formaline	308
Four-ways powdering	303
Four-colour process	359
Fume chamber	98
Funnels	103, 123
Funnel stand	104
G ALLIC acid	304
— Galvanit	341
Gauge pins	212
Gauges, Metal	228
Gear, Screen adjustment	56
Gelatine	35, 237, 271, 285, 297
— coating on screen	35, 271
— dry plates	112, 249
— substratum	236
Gilbert Harris overlay	346
Glass cells	348, 354
— Cleaning	49, 110, 235, 246
— paper	172
— wool	123
Glazed roller	171, 305, 312
Glossy prints, Preparing	372, 378
Glue, Cologne	291, 308
— Fish	123, 220, 284, 285, 289, 293
— seum	311
Glycerine	35
Glycin	218, 247
Goerz lens	75
Gold size	172
Grain backgrounds	332

INDEX.

	PAGE		PAGE
Grained screens	29, 38,	273	
Graining bath		132	
Gravers	176,	331	
Gravity bulb	108,	216	
Green scum on copper		311	
Grey scale in colour work		358	
— filter in colour work		360	
Grid for sink	90,	92	
Ground-glass		258	
Gum enamel process		284	
— for aerograph work		374	
— in etching bath		307	
— solution	173, 243, 249,	269, 304	
Guide mark		300	
Guillotine	111,	191	
Gum-cotton	217,	244	
Gutta-percha baths		100	
— funnels		103	
HALF-TONE PLATES			
— Half-tone, Definition of		13	
— High lights to		16	
— Half-tones, Photographing from		378	
— Coarse		32	
— shadows in		16	
Hammers		194	
Hand rest		173	
Heating of dark room		87	
High light dots	21,	269	
Hoist for printing lamp		116	
Holder, Screen and plate		50	
Holmstrom etching machine		325	
Holt etching machine		328	
Holt's vignetter		311	
Homocentric lens		74	
Homonoc		357	
Hook-bath		100	
— graver		334	
— Zinc		196	
Horizontal baths		100	
Horse-power	137, 139,	197	
Hot plate	158,	165	
— water bottle		35	
Hunter's screen gear		59	
Husnik's overlay		344	
Hydrochloric acid	235, 249,	296	
Hydrometer		164, 222	
Hydroquinone	218, 240, 247,	251	
Hyposulphite of soda	239, 245, 248,	251	
I			
IDEAL printing frame		127	
— Illuminating lens		178	
— the copy		150	
Illumination, The	150,	256	
— of dark room		92	
Immediographic		298	
Imprints	180,	330	
Indiarubber cloth		170	
— for proofing		343	
— rollers		134	
— solution	218, 236,	295	
— substratum		236	
Indirect method in colour work		350	
Ink knives	135,	173	
— Photo transfer		283	
— slab	116, 133,	170,	
— table		213	
Inking up	116, 158,	277	
Inks		223	
— for colour work		358	
Intaglio plates		369	
Intensification	241, 248, 249,	252, 268	
Iodides and bromides	217, 237,	368	
Iodine	34, 235, 238, 241,	245	
Iodiser		216	
Iris diaphragm		75	
Iron block for proofing		211	
— chloride		308	
— Perchloride of	163, 222,	228, 237	
		308, 313	
— Sulphate of	218, 238, 239,	240, 307	
Irradiation		24	
Irregular grain screens	29, 38,	273	
J			
JAFFE paper		282	
— Jig saws		188	
Joining up of dots		262	
Jugs, Acid		161	
K			
KLEIN'S colour filters	318,	356	
— Klingsch screen gear		59	
Koenig's filter solutions		351	
L			
LAMINATED backing	229,	340	
— Lamp, Dark room		94	
— safe light		94	
— Lantern, Dark room		93	
Lamps, Arc	141, 146,	151	
— for colour work		155	
Lascelles' process		251	
Lavender, Oil of	280,	299	
Lead-lined troughs	92,	110	
Lead nitrate	242,	249	
Lemons, Oil of		280	
Lens, The		71	
— Apochromatic Tessar		75	
— Cooke process		73	
— Collinear		74	
— for half-tone		71	
— Goetz		75	
— Orthostigmat		74	
— Planar		75	
— Protar		75	
— Ross homocentric		74	
— Steinheil orthostigmat		74	
— Voigtlander's collinear		74	
— Zeiss		75	
Lenses		71	
— Le Page's glue	220,	285	
Lettering gauges		180	
— stamp press		181	
Levy acid blast		318	
— circular screen	33,	352	
— etch-powdering machine		168	
— plate holder		51	
— whirler		120	
Lighting of etching room	158,	184	
— printing room		116	
Lining beveller		202	
— up plates	202,	335	
Linley screen gear		59	
Liquid colour filters		354	
Litho crayon		316	
— ink	223, 302,	304	
— press		182	
— roller		170	
— stone		170	
— varnish	171, 224,	304	
— writing ink		224, 299	
Litmus paper	233,	308	
Long focus lenses		72	
Lumière's plates and filters		348	
M			
MACHINE etching		318	
— Machinery, Power		188	
Magnesia	296, 312,	317	
Manganese oxy-sulphate		283	
Magnifier, Engraver's	177,	334	
Many liners		176, 331	
Marine glue		162	
Mark Smith etching machine		325	
Masking for aerograph		376	

INDEX.

	PAGE		PAGE
Mastic	279	Parallelism of the camera	254
Materials	215	Para rubber	237, 244
McLaughlin printing frame	127	Passing bath	223, 299, 300, 368
Measures and scales	101, 125	Patent plate	110
Mercury intensifier	242, 252	Paynetype	297
— vapour lamp	155	Penrose diaphragm system	72, 262
Metal printing room	113	— Screen and plate holder	50
Methyl violet	288, 293	— screen and plate-holder	54
Methylated spirit	125, 134, 226, 235,	— — adjustment gear	56
239, 244, 289, 293, 297, 305		Pens	373
Metal developer	251	Penumbral action	250
Metallic mirrors	81	Pernanganate of potash	231
Metzograph screen	39, 273	Perchloride of iron 163, 222, 228, 309, 323	
Microscope	82, 264	— Strength of	309
Mirror box	78	Periodicity, Electrical	143
Mirrors and prisms	44, 78	Perkins's copyboard	69
— Cleaning	81	Persal	222, 309
— Sizes of	81	Photo-litho print on zinc	304
Mogul varnish	162	— process	282
Moiré in colour work .. 33, 351, 360, 362,		— transfer ink	223, 283
369, 378		— — paper	282
Moisture on screen	35, 271	— — Sensitising of	282
Mole's mechanical underlay	347	Photo-lithography for offset press	365
Mortar and pestle	103, 125	Pickle, Film removing	236
Motor acrograph	373	Piercing clamps	336
Motors, Electric	197	Pinachrome	357
Mounting	186, 206, 338, 340	Pinaeyanol	357
— metal	230, 340	Pinaverdol	357
— wood	195, 205, 229	Pinhole camera principle	22, 262
Muslin	124	Pio etching machine	327
N AILING machine, automatic 194, 338		Pins, Gauge	212
— Nail punches	193, 338	— in copyboard	69, 82
Naphtha	134	Pinning up copy	70, 82, 255
Negative Character of	272	Pitch	162
— for offset work	367	Plane, Backing	206
— machine etching	323	Planer, Rotary	206, 339
— Glass	110	Planar lens	75
— Making the	254	Plate brush	174
— Printing from	274	— cooling trough	166
Negro pencils	374	— holder	51
Newspaper work, Coarse half-tones		— holders, Rubber	103
for	32	— lifting tools	194
Nickeline solution	341	— racks	109
Nitrate of silver 215, 233, 240, 241, 252		— speeds	250
Nitric acid .. 222, 234, 236, 244, 299, 306		— tongs	130, 166
Non-actinic fabric	93	Platen presses	214
O FFSET press	365, 370	Platinotypes, Reproducing	266
— process, Plates for	367	Pliers	166
Old films, Removing	236	Pneumatic plateholder	103
Open arc lamps 138, 139, 144, 145, 146		— printing frame	128
Operations, The Photographic	232	— roller	134
Optical plane mirror	80, 81	— whirler	119
Originals, Difficult	266, 272	Polishing bench	114
— for half-tone	372, 378	— screens	34
— reproduction	372	— vice and boards	111, 131, 274
— Lighting of	256	Poppy oil	283
— Preparation of	372	Potash	216, 297, 305, 317
— Protection of	174	Potassium bichromate .. 221, 236, 241	
Orthostigmat lens	74	— bromide	247
Orthochrome T.	357	— carbonate	247
Oven, Drying	118	— iodide	241
Overlay knives	213	— nitrate	307
Overlaying	343	Pouring bottle	105
Oxgall	374	Power for driving machinery	197
P ALETTE knife	173	Powdering box	158, 167
— Panchromatic plates 318, 355, 357		— brushes	168
Paper knife	243	Press, Blocking	210
Papier Josef	34, 235, 246	— Litho	182
Parabolic reflector	146	— Proof	182
Paraffin	134, 295, 305	— Roller proof	183
— wax	35	Pressure frames	125
Parallel, Lamps in	137, 139	Printing	276
		— frames	115, 125, 282
		— lamps	115, 138, 147
		— room	113
		— utensils	123

INDEX.

	PAGE		PAGE
Prisms and mirrors	78	Router	199
Proofing block	211	— cutters	201
— the plates	209, 321, 337, 312	— — Sharpening	201, 337
ink	312	Routing	336
paper	312	Rubber edging	237, 216
— press	209	— solution	218, 237, 241, 249
— rollers	213	Ruling board	178
Protar lens	75	— for negatives	179
Protosulphate of iron	238	— borders	300, 330
Proving ink	224	— pen	179, 299, 373
Pumice	111, 271, 287	— machine	181
— sticks	171	— up negatives	179, 270
Punches	193, 338	Russell powder	278
Push knife	135, 173		
Pyrogallie acid	240	S ABLE brushes	173, 174, 313, 373
Pyroligneus acid	307	Safe light lantern	94, 112
Pyroxyline	217, 237	Sal ammoniac	307
Q UININE filter	355	Salt, Common	297, 317
Quoins, Register	212	Sandpapering the blocks	339
R ACK, Dish	92	Sanger-Shepherd filters	318
Radiator, Electric	49, 88	Saw jig	188
Raised line beveller	203	Saws, Circular	186
Ratios of colour filters	356	Scale of copying	13
Ray screen indicator	63	Scales and measures	101
Reading glass, Use of	257	Schmidt, H. J.	296
Rebiting	312	Scotch transfer paper	369
Rectilinear lenses	71	Scovell-Levy screen and plate-holder	52
Red lead	172	Scorpers	177, 191, 331
Redcol	292, 368	Scratcher	173
Redevelopment	210	Screen, Adjustment of	51, 55
Reductions	13	— and plate holders	50
Re-etching	305, 312	— Brown	29
Reflectors	146	— carrier	51
Reflections on copy	151, 255	— Chessboard	29
Register quoins	212	— Dargavel	381
Registering colour work	314	— Distance	26, 50, 57, 260, 263
— gauges	211	— Economic	30, 36
Reliance press	210	— Enlargement of	28
Reproducing engravings	378	— Gauze	29
— half-tones	378	— Grained	29, 39
Resin	167, 221, 278, 302, 304	— Haas	29
Resistance coils	88, 156	— Holt	37
Reversing	78	— Jacobi	29
Rocker for bath	101, 133	— Johnson	29, 38
Rocking stand	161	— Levy	29
Roller Composition	133, 172, 213, 276, 301	— Levy's four-line	36
— handles	172	— pitch	32
— Indiarubber	172	— Proportion of black to white	32
— Litho	170, 301	— rulings	31
— nap	170	— Schulze's	37
— Pneumatic	134	— The	13, 28
— Proof press	182	— Wavy line	38
— rack	170	— Wheeler's Metzograph	39, 273
— scraper	171	— Wolfe	29
— Velvet	283	— 400-line	31
Rollers	170	Screens, Angles of	33, 352
— Cleaning	134	— Choice of	31
— for colour work	213	— Circular	33, 332
— Glazed	171, 305, 312	— Classification of	32
— Leather	135, 171	— Cleaning of	34
— Preparation of	134	— Coarse	264, 301
— Scraping	171	— Cost of	30
Rolling-up bench	169	— Etching of	29
— process	169, 304	— for emulsion work	33
— stone	170	— Irregular grain	39
Rope swing	65	— Manufacture of	29
Rotary copyboard	351	— Moisture on	35, 271
Rotary-cut surfacer	206	— Polishing	34
— cutter holder	201	— Preservation of	34
— planer	206, 339	— Repairing	30, 36
Rouge	34, 81	— Ruled, for colour work	33, 352
Roulettes	175, 332	— Ruling of	29
Rouletting	332	— Sealing of	30
		— Specks and bubbles in	34
		— Standard sizes of	30
		— Thickness of line in	32, 264

INDEX.

	PAGE
Screens, to prevent sweating on	35, 271
— trial sizes	30
Screw pressure frames	125
Scum in etching	311
Selvyt cloth	235
Sensitising dyes	245, 247, 356, 357
Sensitive solution formulæ	275, 278
Series, Lamps in	137, 138, 139
Set squares	179
Shading mediums	332
Shadow dots	238, 250, 252, 265, 269
Shadows, High lights to	24
Sharpening cutters	201, 337
Shears	213
Shellac varnish	169, 225, 300
Shoot plane	189, 334
Siccatives	172
Silver bath	96, 232
— — hooks	100
— — Strength of	215, 233
— — Testing	102
— nitrate	215, 233, 240, 241, 252
— prints, Reproducing	266, 378
Sink	89, 118, 160
Kyrlight	45, 271
late sinks	89
Smith's adjustable diaphragm	76
Snakestone	174
Soaking trough	92
Soda	134, 236
Sodium bichromate	221
— carbonate	234, 296
— hydrate	251
— sulphide	241, 245, 249
— sulphite	247, 251
Specific gravity of silver bath	108, 216
Speed of plates	250
Spirit lamp	97
Sponges	173
Spray	91
Spring stand	66
Squares	194
Square diaphragms	261, 263
Squaring up colour plates	183
— — negatives	270
Stains on screens	36, 57
Stand, Vertical	71
— Camera	61, 66
Tannate of soda	296
Tarch paste	245
Starting ink	223, 304
Steel	229
Steinheil lens	74
Still	109
Stippled backgrounds	332
Stirring rods	103
Stops, Painting on	282
Stops, Extended	266
— Round	265
— Square	263, 265
— Various shapes of	261, 263
Stopping-down lenses	257
Stop for colour work	77, 354
Stopping-out	313, 315
— varnish	174, 226
Stove	49, 88, 118, 130
— Burning-in	129
Straight edge	194
Stripping	217, 218, 244, 249, 270
Studio, Binner Co.'s Sunlight	45
— Construction of	42, 46
— Heating of	49
— Lighting of	42
— Size of	44
— Ventilation of	44
Substratum	220, 236, 237

	PAGE
Sugar in enamel process	285, 294
Sulphide	241, 245, 249
Sulphuric acid	235
Switch, Lamp	137
Swansdown	124
Sweating of the screen	35, 271
Swing	41, 64, 67
— arm tap	91, 117
Syrian asphaltum	280

T ALC	237
— Tallow, Russian	171
Tannic acid	134
Tapered underlay	343
Tessar lens	75
Tetra-brom-fluorescine	357
Three-colour process	348
Three-way carrier	351
Tint backgrounds	332
— — graver	177, 331
— plates	362
Transfer ink	223, 276
— papers	282
Transfers, Photo-litho	282
Transparencies for colour work	351
Traversing gear	45, 152
Tray, Bath	100
Trimming	338
Trimmer	203, 338
Tripoli	235
Troughs, Grooved	91, 110
T square	178
Tub for whirling	68
Turntable for camera	68
Turntable whirler	121, 282
Turpentine	134, 277, 294, 305, 342
— can	213
Two-colour half-tone	362
Tympan	212
Type-high gauge	208, 339
Type metal mounts	340

UNDERLAYING 338, 343

V ACUUM filter	124
— printing frame	128
Valenta's bitumen	280
Vapour lamp, Mercury	155
Varnish, Acid resist	225, 300, 305
— Litho	135, 304
— Stopping out	226
Varnishing	243, 269, 300
Vaseline	279
Venice turpentine	280
Ventilation of dark room	85
Vertical copying stand	71
Vibration	48, 64, 336
Vignetting	314, 331, 336, 343, 377
Vignetting machine	207, 338
Violet dye	289
Voigtlander's Collinear lens	74
Voiron screen gear	59
Voltage	128
V principle in half-tone	21

W ARNERKE tissue	297
— Washleather	124, 235, 311
Waste pipes	90
Water, Distilled	233, 241, 252, 278
— globe	178
— supply for dark room	90
Watson's screen gear	59
Waterhouse diaphragms	75

INDEX.

	PAGE		PAGE
Watts	139	Wire scratch brush	317
Wavy line screen	38	Wood, Mounting	310
Wedge printing frame	126	— vinegar	307
Weights	102	Working aperture	266
Wet collodion process	232	Wratten plates and filters	318
Wheeler's Metzograph screen ..	39, 273		
Whirler	117, 118, 120, 271, 281	Z EISS lenses	75
Whirling	117, 274, 275, 281, 288, 292	— Zinc	226
White for retouching	373	— cutting board	196
Whiting 31, 111, 288, 305, 312, 313, 317		— chloride	308
Window of dark room	92	— hook	196
— — printing room	116	— Polishing	227

INDEX TO ADVERTISERS.

GRAPHIC ARTS Co.	xv.
GRIFFIN & SONS	xi.
HOE & Co	vi., vii.
ILFORD, LTD.	i.
MANN & Co.	xvi.
MAX LEVY	xii.
PENROSE & Co.	ii., iii., xvi.
ROYLE & SONS	viii., ix.
FAYLOR, TAYLOR & HOBSON	xiii.
WINSTONE & SONS, LTD.	xiv.
WRATTEN & WAINWRIGHT, LTD.	iv., v.

ILFORD

PLATES

of Special Interest
to Workers in the

Half-Tone Process.

ILFORD HALF-TONE PLATES

Good Dots. Clean Working. Rapid Exposures.

ILFORD PROCESS PLATES

for copying Prints, Maps, Plans, Line-Engravings.

ILFORD PANCHROMATIC PLATES

Sensitive to all Colours, Extreme
Speed. — Sharp, Dense Dots.

*All Ilford Plates are supplied Backed (Anti-Halation) to order
At popular Prices, of all Dealers.*

ILFORD, Ltd., Ilford, LONDON, E.

PENROSE'S

IS THE WORLD'S HEADQUARTERS FOR

Process Supplies



"PENROSE'S IS THE BEST"

is an axiom with all process workers.

THE PENROSE Process Supply Stores were founded in 1893, as a branch of chemical business established sixty years before.

At the time the idea of a "universal provider" stores for process workers was an entirely new one, nothing of the kind having been attempted before.

It proved the fulfilment of a long felt want, and the business has grown to be one of the world's biggest and most famous industrial concerns, employing a large staff of specialists and workmen, and having extensive factories for the manufacture of cameras, machinery, apparatus, and materials required by the trade.

Such a success could not have been built up if the firm had not rendered good service to its customers, and the fact that the business is still growing rapidly proves that the old reputation is being maintained.

Practical advice, assistance, and instruction is given to customers by our experts.

We not only sell but also make, as far as practicable all our specialities, having extensive workshops adjoining our warehouses.

A. W. PENROSE & Co., Ltd.,
109, Farringdon Rd, LONDON, E.C.

And at . .

PARIS, BERLIN, AMSTERDAM, MADRID, MILAN, SYDNEY, BOMBAY,
TORONTO, NEW YORK, AND CHICAGO.

Telephones: 1891 and 1296 Holborn.
9663 and 14813, Central.

Telegrams: 'Zincograph, London.'
Codes: A.B.C. 5th, Edition, and
Western Union



A Penrose Outfit for Half-Tone.

Outfits vary within wide limits according to requirements, but the following may be taken as an example of a moderately small equipment:

12 x 10" Camera with Half-Tone Screen Adjustment	£27	0	0
Spring Copying Stand and Copy board	10	10	0
Cooke Lens, Prism, Diaphragms	26	5	0
Focussing Cloth and Eyepiece		15	6
Pair of Process Arc Lamps, Resistances, and Stands	18	10	0
Levy Original Ruled Screen, 133 lines	18	7	6
Dark Room Equipment, to value of	5	0	0
Whirler	1	2	6
Printing Frame	1	8	0
Burning-in Stove and Plate Tongs	1	13	6
Printing Room Equipment, to value of	3	0	0
Etching Trough	1	7	6
Hot Plate		16	6
Glazed Roller, with handles	1	6	0
Ink Slab and set of Ink Knives		10	0
Ruling Board and T. Square	1	5	0
Various small Tools, Brushes, and Sundries, to value of	3	0	0
Shoot and Bevel Plane Outfit	7	0	0
Treadle Circular Saw Bench	8	8	0
Blocking Plate		18	0
Hammers, Punches, Gravers, and Sundry small Tools for finishing, to value of	2	0	0
Supply of Zinc, Copper, Chemicals, and materials, to value of	5	0	0
	<u>£145</u>	<u>3</u>	<u>0</u>

NOTE—It is possible to reduce the above amount by having a cheaper Camera, a swing instead of stand, mirror instead of prism, "Economic" in place of "original" screen, and by reducing the amounts for Sundries. On the other hand, the amount will be largely increased by the addition of the Router, Beveller, Power Saw, Guillotine, and Etching Machine, which are necessary for doing rapid commercial work.

Estimates promptly furnished to
meet every possible requirement.

The Headquarters for Half-Tone Supplies:

A. W. PENROSE & CO., LTD.,
109, Farringdon Road, London, E.C.

Dry Plates and Light F

The Wratten Process & Process Panchromatic Plate

are of medium speed, *i.e.*, they are *not* slow plates, but they are of extreme density-giving power, and the grain is so fine that irradiation has almost vanished, the result being that in half-tone work the dots obtained remind one of a wet collodion plate, even the shadow dots being perfectly black, while the spaces between the dots are free from all fluff and woolliness, even when the high lights are closely joined up.

For Three-colour Work

modern practice requires that the three-screen negatives shall be made direct through the colour screens upon colour-sensitive dry plates.

This method, avoiding the cost and delay of the indirect process and the many difficulties of collodion emulsion has been made possible by the introduction of Wratten Process Panchromatic Plates.

It is the method which is adopted throughout England by the progressive colour-engravers, it is the method which gives the finest result, and it is the only method which will pay in the average shop.

A simple proof of the small amount of fine etching really necessary, is given by making the negatives through Wratten Tri-colour Screens direct on Process Panchromatic Plates, and after printing those negatives on the metal, deep etching them flat, and proving the blocks in colour before fine etching.

Blocks should be fine etched to *correct* them, not to *make* them.

For further information about Dry Plates for Process Work write for the special booklet, "Screen Negative Making on Dry Plates."

Agents for the Photo-Engraving and Printing Trades :

UNITED KINGDOM—all the usual dealers in process supplies, and Messrs Kodak, Ltd., Kingsway, W.C.

UNITED STATES OF AMERICA—The Eastman Kodak Co., Rochester, New York
CANADA—The Canadian Kodak Co., Ltd., Toronto.

AUSTRALIAN—The Australian Kodak Ltd., Melbourne.

FRANCE—M. H. Calmels, 150, Boulevard du Montparnasse, Paris.

WRATTEN & WAI

ers for Process Work.

Wratten Light Filters

both Orthochromatic and Tricolour, are of the highest efficiency. They are cemented in selected optical glass, and also in accurately surfaced "Flats" specially tested to give perfect definition and register.

A Set of Wratten Flat Tricolour Filters

represents the perfect equipment for the process worker, and enables him to ensure that every set of blocks he makes will give perfect register when printed.

Many books and booklets are published by us dealing with plates and filters, of which the following are the chief:

"The Photography of Coloured Objects,"

By C. E. Kenneth Mees, D.Sc.; 76 pages, with 14 full-page half-tone illustrations, coloured chart, and photo-gravure frontispiece. Price 1/- nett, 1/3 post free. This book contains a discussion of the theory of colour in its relation to photography, and chapters dealing with the application of the general theory to special branches of the subject. It has a large circulation, and is the standard text book on the subject.

"Orthochromatic Filters"

Which discusses the use of Light Filters for all purposes. 56 pages, fully illustrated, and bound in boards. 6d. post free.

"Real Orthochromatism"



(Seventh edition). This explains the reason for the use of Orthochromatic, and especially Panchromatic Plates, and gives exact instructions for the use and development of Panchromatic Plates.

"Screen Negative Making."

This explains the considerations which were involved in the making of our "Process" and especially "Process Panchromatic" Plates, and gives complete working instructions for the preparation of direct three colour screen negatives on Dry Plates.

WRIGHT L^{TD}, CROYDON

R. HOE & Co.'s

ELECTROTYPING
STEREOTYPING and
PHOTO-ENGRAVING
MACHINERY  

ROUTING
 BEVELLING
 TRIMMING
 DRILLING
 PLANING
 AND
 SQUARING
 MACHINES.

MOULDING
 WAX-SHAVING
 BLACKLEADING
 SHAVING
 ROUGHING
 AND
 SAWING
 MACHINES.

SUPERIOR IN CONSTRUCTION
 UNEQUALLED FOR DURABILITY
 CONVENIENT IN OPERATION.

MATRIX ROLLING MACHINES.
 COAL AND GAS FURNACES, etc., etc.
 IMPROVED HEAVY HAND PRESSES.

SEND FOR CATALOGUE SHOWING LATEST DESIGNS, TO

R. HOE & Co., Borough Road,
 LONDON, S.E.

Also Grand Street, NEW YORK, BOSTON, CHICAGO, and PARIS.

R. HOE & CO.'S

IMPROVED

FLAT ROUTING MACHINE.

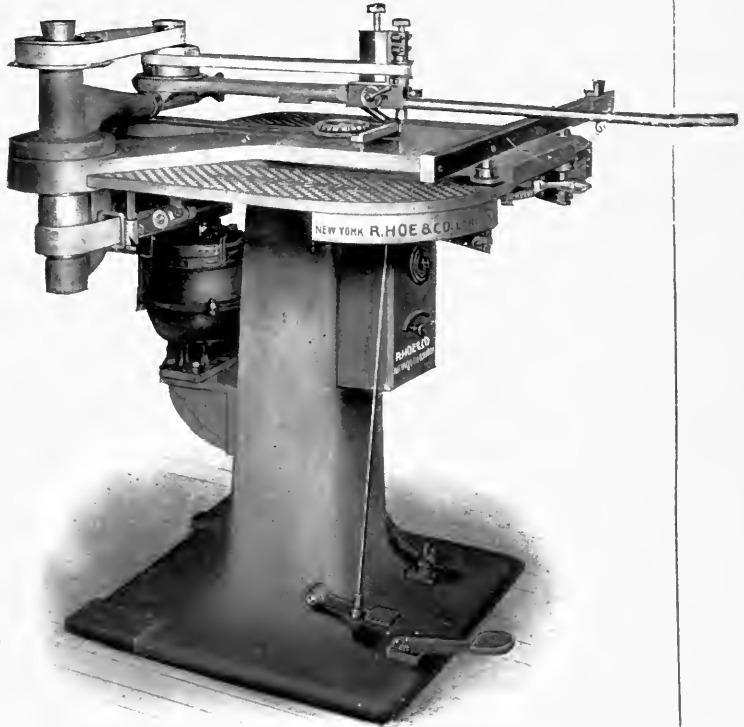

This machine is substantially built throughout, designed not only for the roughest kind of work, but also having that delicacy of touch so essential in routing engraved plates of copper, zinc, or brass.

The construction of the machine is such that there is no vibration of the table or cutter head.

The above engraving illustrates the Router fitted with direct connected motor on the pedestal, the starting rheostat being fixed in a position convenient for the operator.

FOR FURTHER PARTICULARS APPLY TO

R. HOE & CO., BOROUGH ROAD, LONDON, S.E.,
And at BOSTON, NEW YORK, CHICAGO, AND PARIS.

ROYLE'S Photo-Engravers' Machinery

Is the Standard throughout the World.

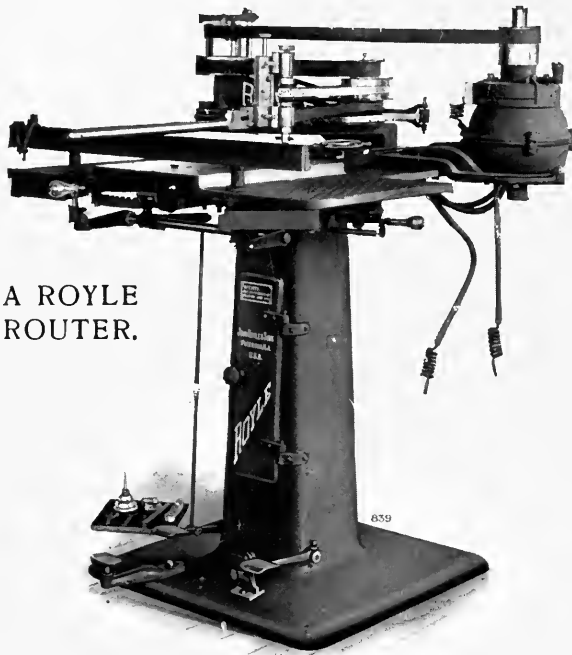

A ROYLE
ROUTER.

Wherever photo-engraving is practised ROYLE'S MACHINES will be found, and workers of all nations approve them as undoubtedly the best in mechanical excellence and efficiency. The Royle Router was the first machine of its kind when introduced in the early 60's, and it stands to-day at the head of all such machines. Upwards of 1,000 Royle Routers are in use. Can there be a better testimony ?

ROYLE MACHINES

are so beautifully built that they never give trouble when fairly used. They are a delight to the good workman, and an earning power for the employer. Everyone has a good word for these machines.

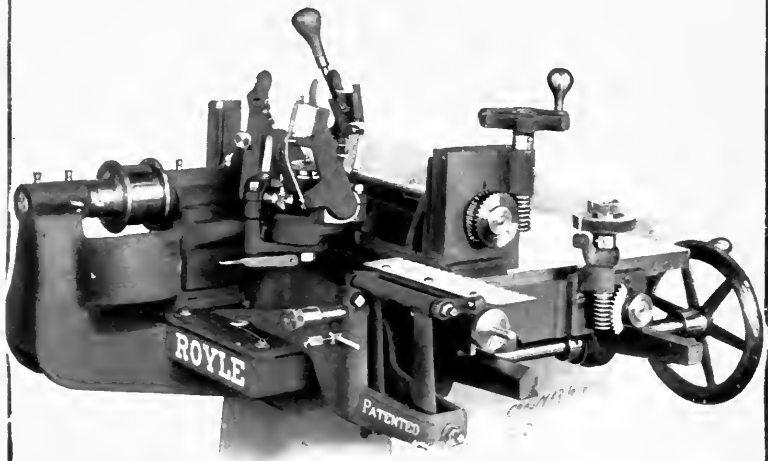

The Royle Lining Beveller.

Beside Routers and Bevellers, ROYLE'S make equally good Circular Saws, Jig Saws, Trimmers, Edgers, Planers, Drills, Shoot-Boards, and many other specialities for the Photo-Engraver. ROYLE'S have made a life-long study of this particular work, not only from the side of the machine builder, but from the side of the user, striving to supply the trade with just the tools it wants.

ROYLE CUTTERS

“The Cutters that Cut.”

The firm of Royle have made a world-wide reputation not only for their machines, but also for the cutters they put in their machines.



Royle Router Cutters.

ROYLES maintain a special factory for making Router Cutters, where every possible mechanical device is employed to make the cutters as good and perfect as they possibly can be in shape and temper. These cutters make the router hum with that pleasant sound which denotes good and quick work.

A WORD TO THE WISE—

If you have not Royle's Machinery your plant is not returning the profit it should, and you are not turning work with the finish that pleases the customer. Write us, and we will show you that we have just what you need to put your machinery on a paying basis.

JOHN ROYLE & SONS,
PATERSON, N.J., U.S.A.

Sole British Agents:

A. W. Penrose & Co. Ltd., 109, Farringdon Rd., London,
E.C.



FOR THE PROGRESSIVE PHOTO-ENGRAVER.

AUTOFOCAL CAMERAS.

The one Camera on the market which permits the operator to fix the correct screen distance instantly and with unflinching accuracy, for screens of ALL rulings and for any scale of enlargement or reduction—and this, without interfering with or hampering the operator's individual judgment or method of working.

UTILUX LENSES.

Made from a glass which is highly transparent to ultra-violet light, the UTILUX LENS allows full advantage to be taken of the higher efficiency of the enclosed arc lamps now so universally used and combines Optical Perfection, Increased Speed, and REASONABLE Cost.

KAHLBAUM MIRRORS.

All-metal Mirrors, optically surfaced and polished, which DO NOT tarnish, lose rapidity, or need re-silvering. They remain absolutely unaffected by atmospheric conditions and are an additional and valuable aid to increased speed of working.

KOH-I-NOOR SCREENS.

Achieve the utmost perfection obtainable in screens for half-tone and colour work. Diamond engraved and etched on glass of perfect flatness and transparency and PERMANENTLY sealed. KOH-I-NOOR Screens are framed with an Aluminium binding applied by a method which does not reduce or weaken the edges of the screen.

KOH-I-NOOR "Ruled" Screens—ruled but not etched—are supplied at prices 50% below those of the engraved screens and while thoroughly efficient are substantially economical where large sizes are required.

KOH-I-NOOR Schulze Screens, ruled in accordance with a patented formula, in coarse rulings are especially useful for Press illustration, blocks produced with them holding relatively greater detail without increased difficulty in printing.

Copper and Zinc Plates. Chemicals and every requisite

FINEST QUALITY. LOWEST PRICES. PROMPT DELIVERY.

JOHN J. GRIFFIN & SONS, LTD., KEMBLE STREET,
Kingsway, LONDON, Eng.

Telegrams & Cables : "Gramme, London." Code : A.B.C. 5th Edition. Telephone : Gerrard 2621.

MAX LEVY'S SCREENS

The Standard all over the world for Half-Tone work.

For Half-Tone,
Colour Work,
Emulsion,
Dry Plates,
Photogravure.



The Recessed Aluminium
Binding.



These screens are engraved with a diamond point by the most perfect machinery, and the lines are etched into the glass. The edges being bound with aluminium the screens are imperishable.



THE LEVY CIRCULAR SCREEN and ROTARY SCREEN CARRIER.

Forms the best equipment for colour work as it guarantees accuracy of Register, and freedom from pattern in two, three, and four colour work.

Foreign Selling Agents :

ENGLAND : A. W. Pentrose & Co. Ltd., London.

GERMANY & AUSTRIA : F. Hemsath, Frankfurt,
a/M.

FRANCE : J. Voirin, Paris.

JAPAN : R. Konishi, Tokyo.

AUSTRALIA : Middlows Bros., Sydney.

SOUTH AMERICA : H. Stein, Buenos Ayres.

MAX LEVY,
Wayne Avenue, and
Berkley Street.
Wayne Junction,
Philadelphia, Pa, U.S.A.

The Cooke Process Lens and Prism With Penrose Diaphragm System.

Is reckoned by all the best Optical equipment for
Process Work.



GOOD ALL-ROUND FOR LINE, HALF-TONE,
AND COLOUR WORK.

The Cooke Lens gives a sharp all-over-image.

It is simply designed, accurately made, and beautifully finished.

It is in fact the acme of perfection.

Not an expensive outfit when you consider the everlasting good service it renders.

Manufactured by

TAYLOR, TAYLOR & HOBSON,
LEICESTER.

Sole British Selling Agents:

A. W. PENROSE & Co., Ltd., Farringdon Road,
London, E.C.

B·WINSTONE
& SONS LTD



LITHOGRAPHIC INKS
LITHOGRAPHIC

& LETTERPRESS
VARNISHES,
SUNDRIES ETC.

100 101
SHOE LANE
LONDON E.C.



BOEKDRUKCLICHES
BANDSTEMPELSTEEKENINGEN
VETDRUKKEN

Dirk Schnabel

Chemigrafische Kunstinrichting

ADM. DE RUYTERWEG
AMSTERDAMTELEGRAM-ADRES.
DIRK SCHNABEL - AMSTERDAM*TELEFOON INTERC
N^o 2807

1 Februari 1911

Graphic Arts Company, (Translation.)
Philadelphia.

I take pleasure in stating that the Levy Acid Blast Etching Machine obtained from you fulfils in every respect all my high expectations of it.

The Acid Blast has many very important advantages over either of the two cheaper European machines which I have had in use, both as regards the quality of the work produced and durability of construction.

Hoogetend.
W. D. D.
Dirk Schnabel

UP TO JUNE 1st, 1912—

Seventy-seven (77)

Levy Acid Blast Etching Machines

have swept aside all kinds of cheap imitations of the

ACID BLAST PROCESS THROUGHOUT EUROPE

from London, Paris, and Amsterdam at the West, to Budapest, Hungary, in the East, and from Stockholm, Sweden, at the North, to Rome and Milan in the South.

GRAPHIC ARTS COMPANY,

Patentees and Manufacturers,

1221, SPRING GARDEN ST.

PHILADELPHIA, PA.

BRITISH AGENTS: A. W. PENROSE & Co., LTD., 109, Farringdon Road, LONDON, E.C.

MANN

ROTARY OFFSETS

MANN

R
O
T
A
R
Y
S

O
F
F
S
E
T

THE ONLY
MACHINE FOR PERFECT
PHOTO-MECHANICAL
PRINTING.

R
O
T
A
R
Y
S

O
F
F
S
E
T

LARCHFIELD WORKS, HUNSLET,
LEEDS.

MANN

HENRY ST., GRAY'S INN ROAD,
LONDON.

MANN

A Companion Text Book to . . .
"The Half-Tone Process" is . . .

"LINE PHOTO-ENGRAVING"

THE MOST COMPLETE & PRACTICAL HANDBOOK ON ALL PHOTO-MECHANICAL AND OTHER PROCESSES OF LINE ENGRAVING

By WILLIAM GAMBLE, F.R.P.S.,

Editor of the "Process Year Book" and "Process Work."

Price 7/6 Nett; Post free, 7/10.

Published by

A. W. PENROSE & Co., Ltd., 109, Farringdon Road, London, E.C.

For Colour Work use

Penrose's Panchromatic Process Plate

For Half-Tone or Line use

Penrose's Graphic Process Plate.

They are made for Process Work, and are the right thing at the right prices.



A. W. Penrose & Co., Ltd., 109, Farringdon Rd., London, E.C.

Photography and FOCUS

Edited by R. Child Bayley.

The most influential photographic
. . . paper in the world . . .

Helpful to every
camera worker.
Splendidly illus-
trated by half-
tone reproductions
of the best work
of the day.

Every Tuesday. Price One Penny
— of all Newsagents. —

Publishers :
Iliffe and Sons Ltd., 20, Tudor St., London, E.C.

Books for Photographers

Photography for Naturalists.

By Douglas English.

A handbook which every photographer who attempts work on "dumb animal" studies should read. Profusely illustrated by photographs from living objects. Cloth bound.

PRICE 5/- NETT. BY POST, 5/4.

Science and Practice of Photography.

By Chapman Jones,
F.I.C., F.C.A., F.R.P.S.

For many years "Science and Practice" has been the text-book of all photographic schools and classes. Fourth edition. Rewritten and greatly enlarged.

PRICE 5/- NETT. BY POST, 5/4.

The Studio, and What to Do In It.

By H. P. Robinson.

This book has been the standard work on this subject for some time, and still holds its place in the first rank. Illustrated.

PRICE 2/6 NETT. BY POST, 2/8

A Treatise on Photogravure.

By Herbert Denison.

The methods of photogravure have been supposed to be trade secrets, and have often been sold as such. In this book Mr. Denison gives full and sufficient directions to enable any photographer to take up the process, and work it successfully.

PRICE 4/6 NETT. BY POST, 4/10.

Hand Cameras.

By R. Child Bayley.

This book has been written with the object of helping the amateur worker to get the best possible result from his instrument whether it be a half-plate Reflex or a vest pocket camera. Special chapters are devoted to the Lens—Shutters—Focussing—Exposure—the Reflex—Orthochromatic and Telephoto Work, etc.

PRICE 1/6 NETT. BY POST, 1/9.

Instruction in Photography.

By Sir William Abney, K.C.B.

A classical work by the greatest living authority on scientific photography. Eleventh edition. Revised and enlarged.

PRICE 7/6 NETT. BY POST, 7/10.

Photographic Enlarging.

By R. Child Bayley.

Full working details for all the ordinary methods of enlarging, including enlarged negative making.

PRICE 1/6 NETT. BY POST, 1/6.

Obtainable from Leading Booksellers, Railway Bookstalls, or direct from ILIFFE & SONS LTD., 20, Tudor St., London, E.C.
Remittance must accompany order.



